

Please read alongwith
item No. R2-RT-16-24

Note:

- * All Steel Components shall be Hot Dip Galvanized
- * Retro Reflective Sheeting on Front and Back of the Sign shall be Type XI as per IRC 67 2012

Cautionary Sign Drawing Refer Fig. C2

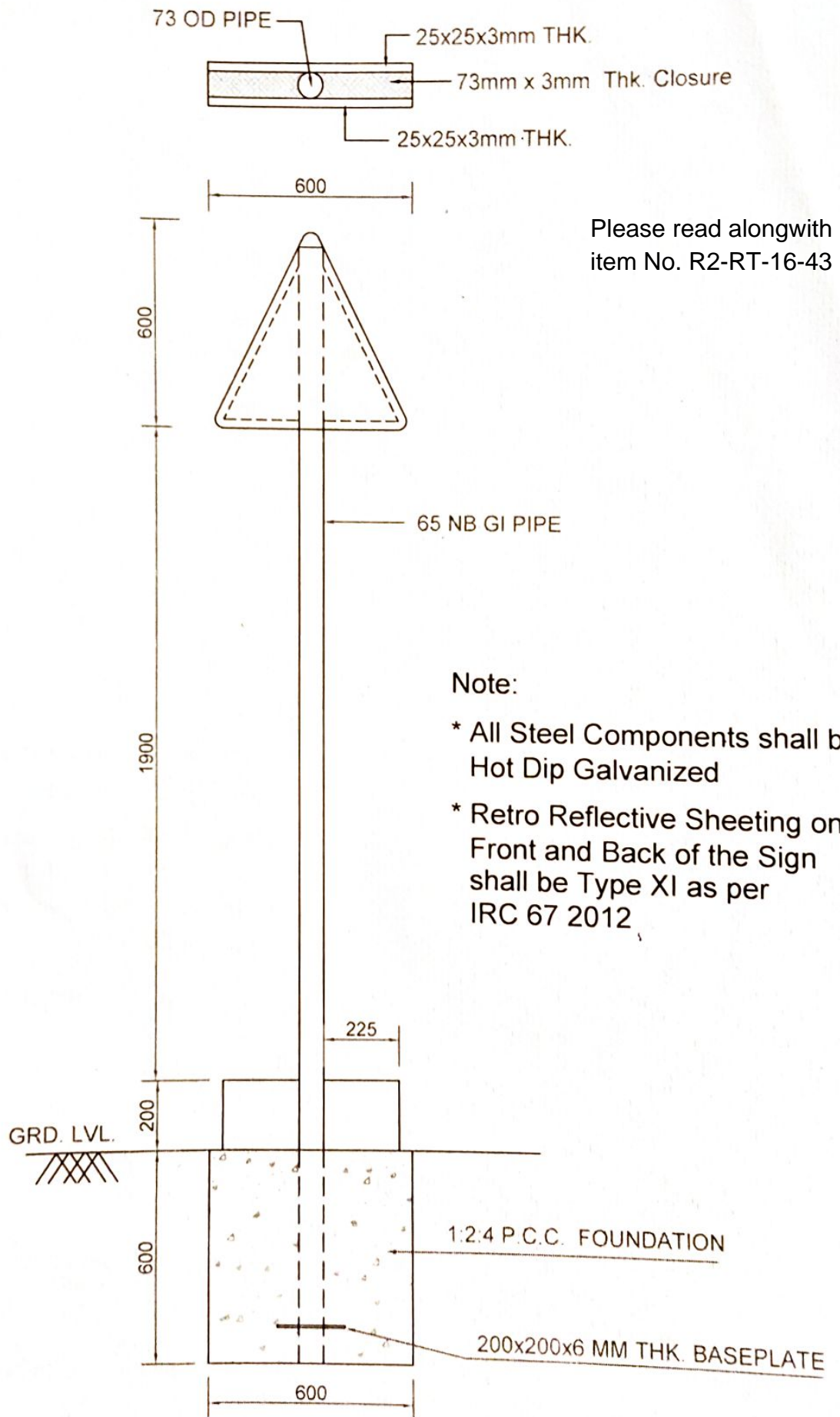

Cautionary Sign Drawing Refer Fig. C1

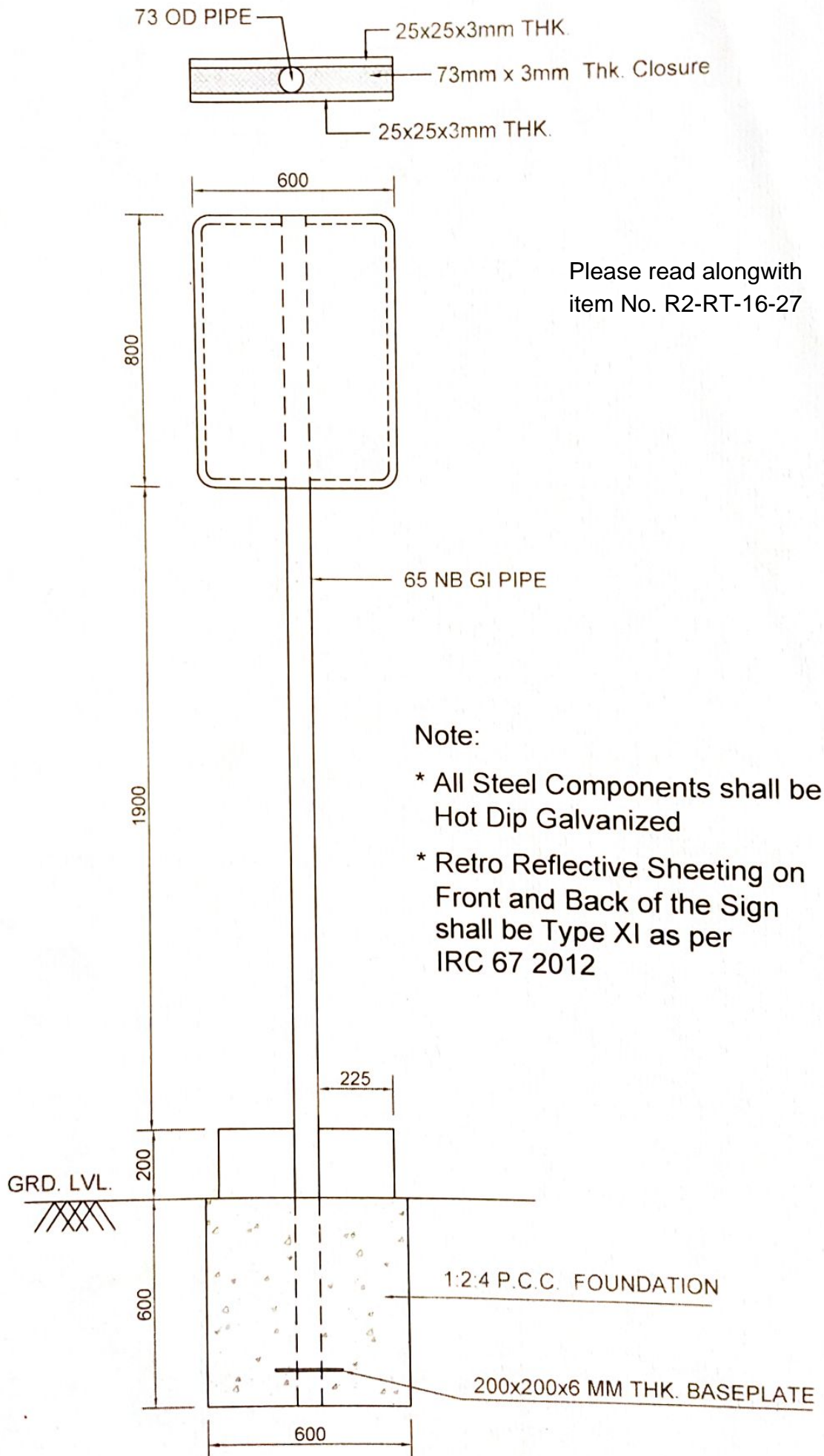

Facility Information Sign Drawing Refer Fig. F1

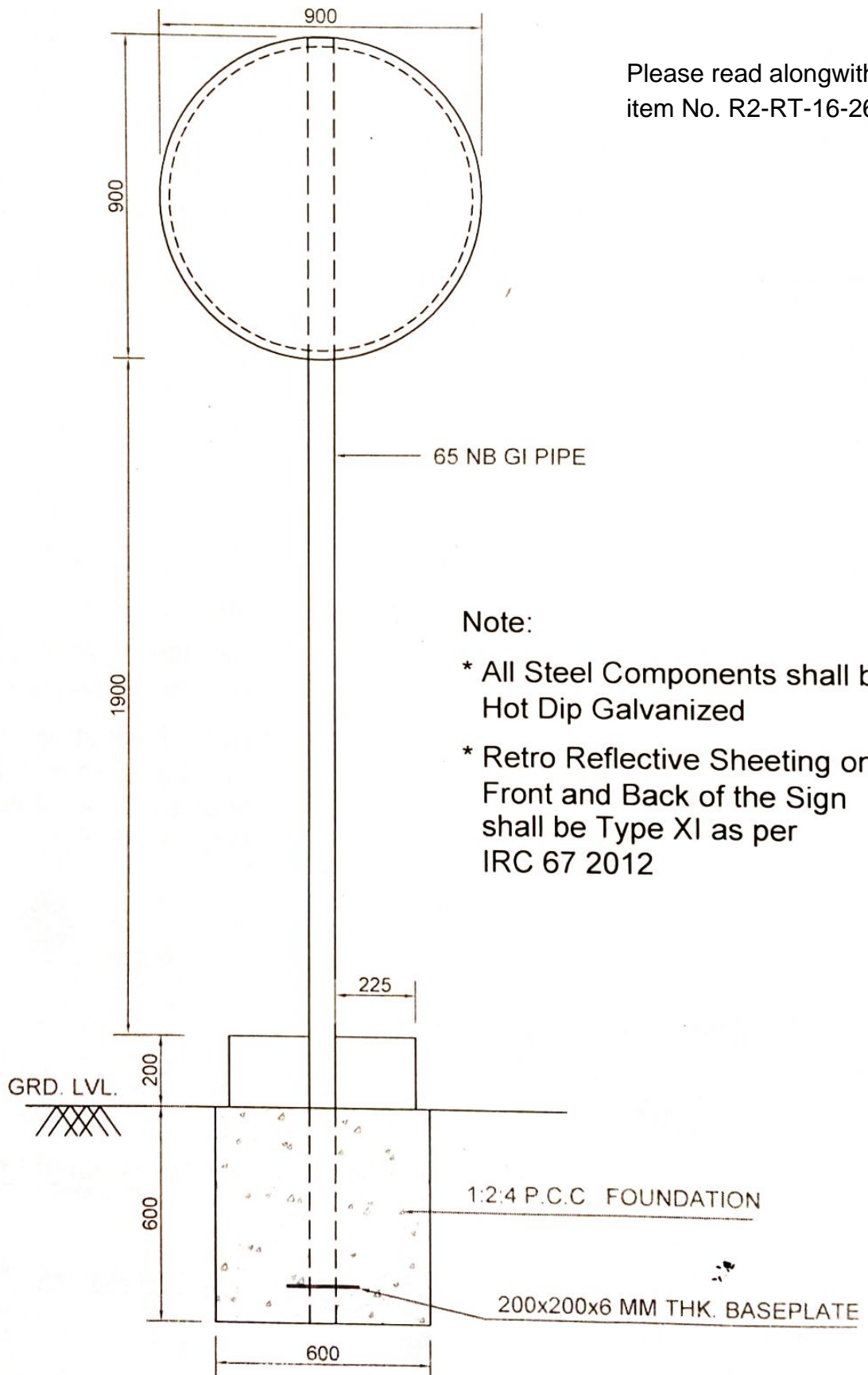
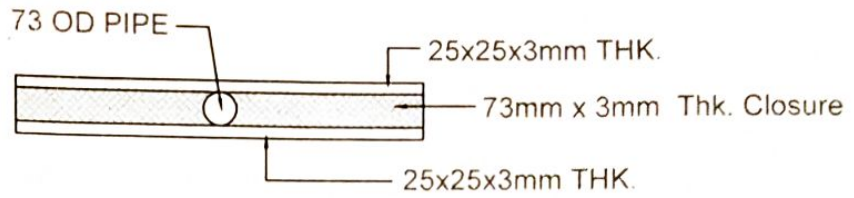

Please read along with
item No. R2-RT-16-26

Note:

- * All Steel Components shall be Hot Dip Galvanized
- * Retro Reflective Sheeting on Front and Back of the Sign shall be Type XI as per IRC 67 2012

Mandatory Sign Drawing Refer Fig. M2

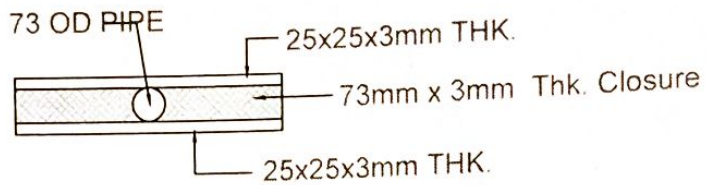

Please read along with
item No. R2-RT-16-23

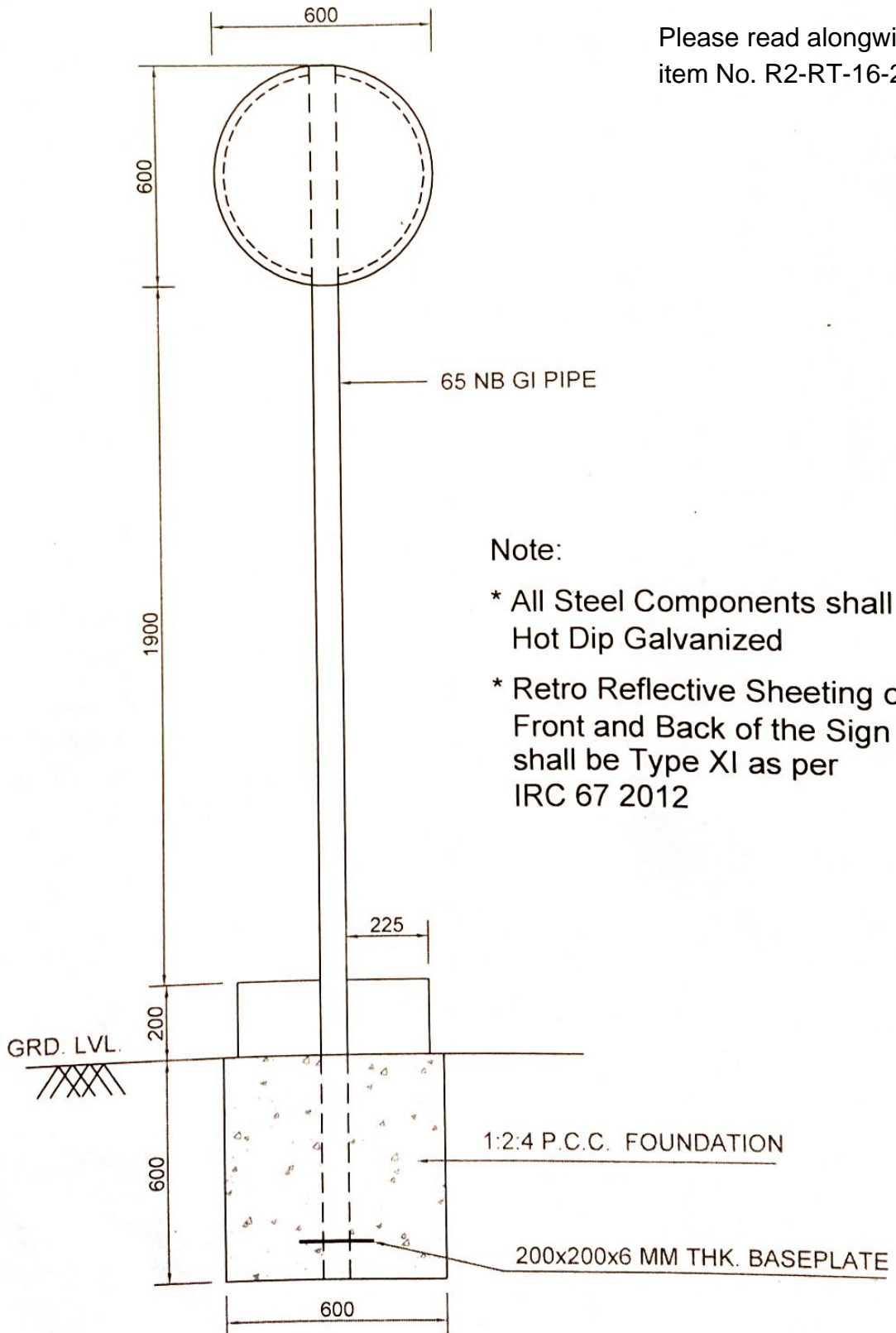

Note:

- * All Steel Components shall be Hot Dip Galvanized
- * Retro Reflective Sheeting on Front and Back of the Sign shall be Type XI as per IRC 67 2012

Mandatory Sign Drawing Refer Fig. M1

- Note
- All Steel Components shall be Hot Dip Galvanized
 - Retro Reflective Sheeting on Front and Back of the Sign shall be Type XI as per IRC 67 2012

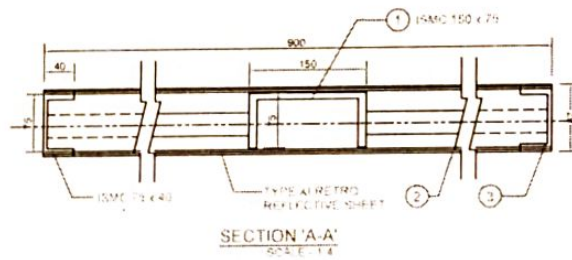
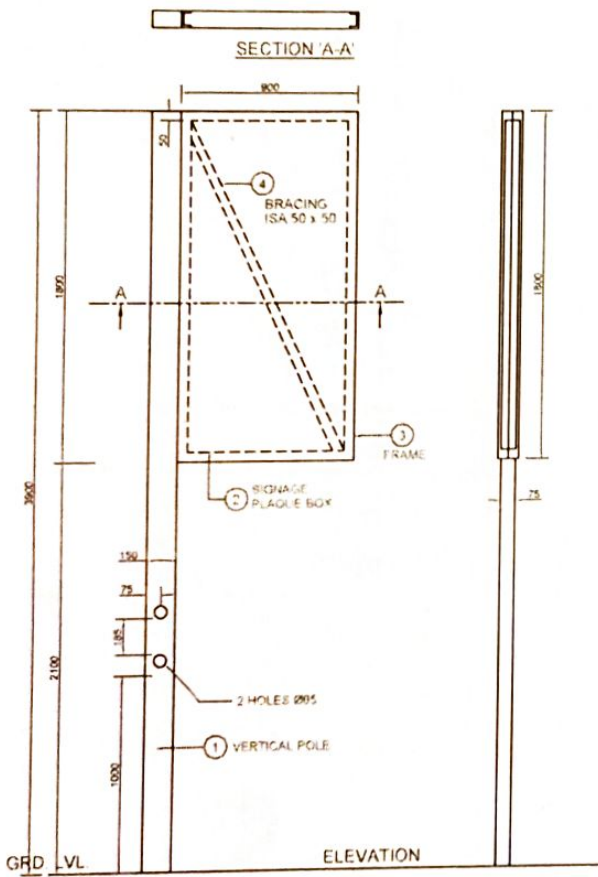

Please read alongwith
item No. R2-RT-16-19

19

FIGURE NO: RT-16-19

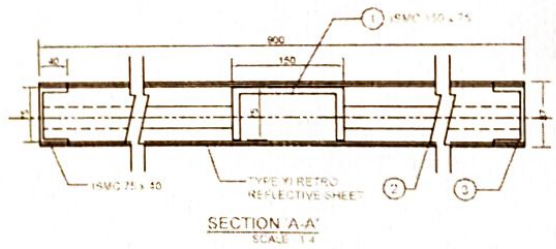
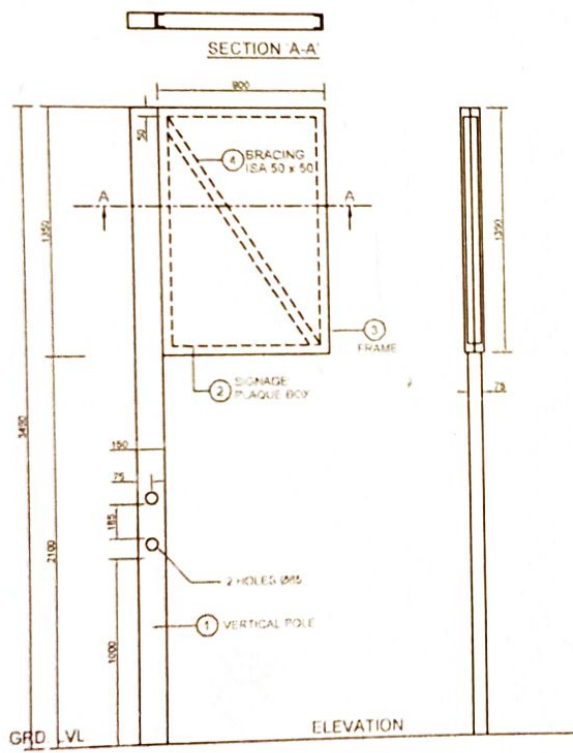

- Note:
- All Steel Components shall be Hot Dip Galvanized
 - Retro Reflective Sheeting on Front and Back of the Sign shall be Type XI as per IRC 67 2012

Please read alongwith item No. R2-RT-16-18

FIGURE NO: RT-16-18

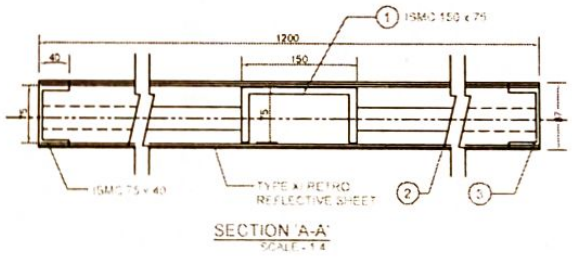
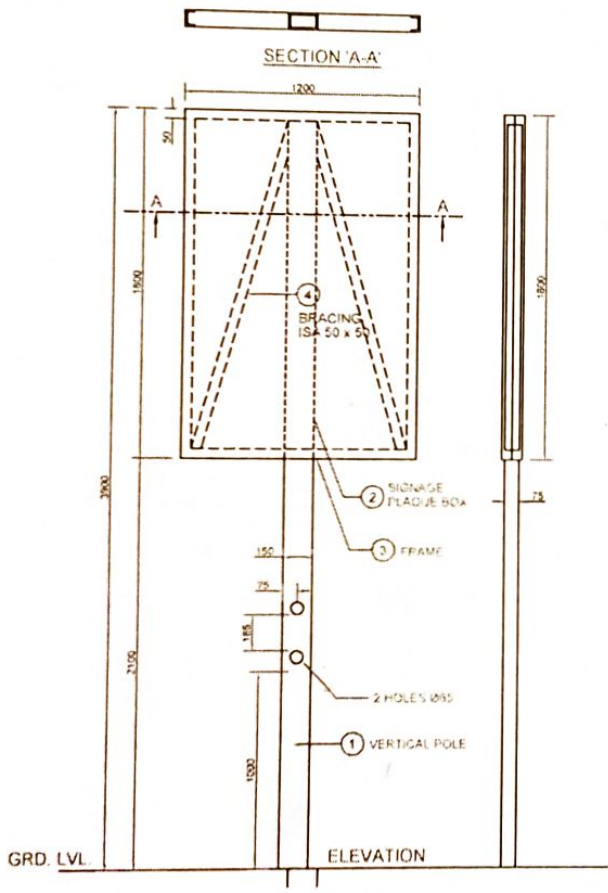

Note

- All Steel Components shall be Hot Dip Galvanized
- Retro Reflective Sheeting on Front and Back of the Sign shall be Type XI as per IRC 67 2012

Please read along with item No. R2-RT-16-21

FIGURE NO: RT-16-21.

21

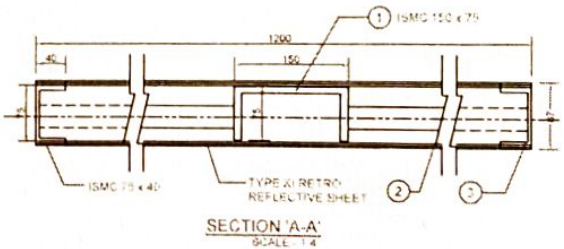
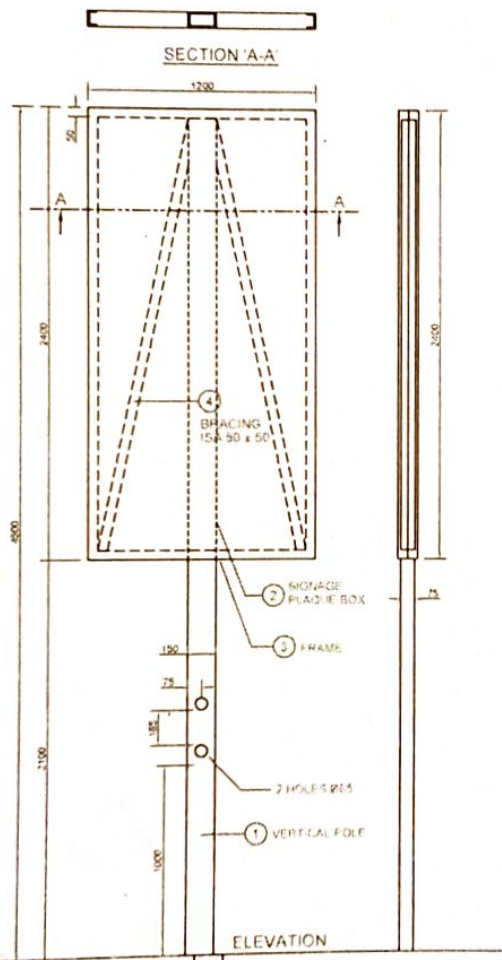

- Note:
- All Steel Components shall be Hot Dip Galvanized
 - Retro Reflective Sheeting on Front and Back of the Sign shall be Type XI as per IRC 67 2012

Please read along with item No. R2-RT-16-20

FIGURE NO: RT-16-20

20

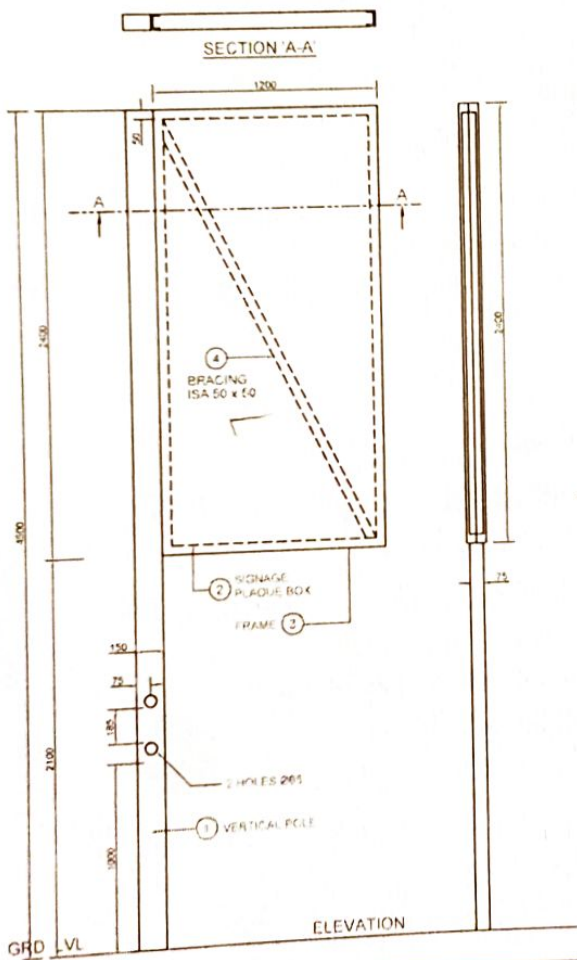

- Note
- All Steel Components shall be Hot Dip Galvanized
 - Retro Reflective Sheeting on Front and Back of the Sign shall be Type XI as per IRC 67 2012

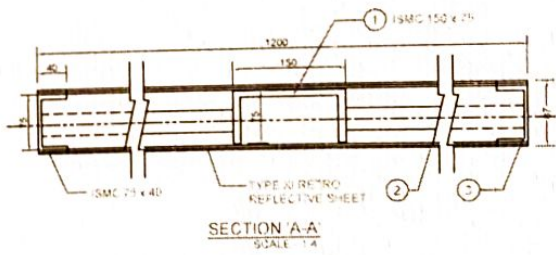

Please read along with item No. R2-RT-16-22

FIGURE NO: RT-16-22