



## **e-Tender Document**

FOR

### **Rehabilitation of Malad WWTF - Treatment of Sewage Water by Bioremediation Technology.**

**Tender ID :2024\_MCGM\_1084227**

Website: <https://mahatenders.gov.in>

#### **Office ofthe:-**

**Executive Engineer Mechanical (Sewerage) W. Subs,  
Versova Sewage Pumping Station,  
Junction of J. P. Road & Link Road,  
Andheri (West), Mumbai-400 053.**

Prepared By

Sd/-

E.E.Mech.(Sew.)W.S.

Checked By

Sd/-

Dy.Ch.E.(SO)W.S.

Approved By

Sd/-

Ch.E.(SO)

## INDEX

SECTION	DESCRIPTION	PAGE NO.
1	E-TENDER NOTICE	4-7
2	ELIGIBILITY CRITERIA	8-11
3	DISCLAIMER	12-14
4	INTRODUCTION	15-16
5	E-TENDER ONLINE SUBMISSION PROCESS	17-23
6	INSTRUCTIONS TO APPLICANTS	24-50
7	SCOPE OF WORK	51-52
8	BILL OF QUANTITIES	53-54
9	GENERAL CONDITIONS OF CONTRACT	55-122
10	SPECIAL INSTRUCTIONS TO BIDDERS	123-126
11	SPECIFICATIONS	127-150
12	FRAUD AND CORRUPT PRACTICES	151-155
13	PRE-BID MEETING	156-157
14	LIST OF APPROVED BANKS	158-161
15	APPENDIX	162-240
16	EXISTING SITE PLAN	241-242

**SECTION 1**  
**E-TENDER NOTICE**

# BRIHANMUMBAI MUNICIPAL CORPORATION

Chief Engineer (Sewerage Operations)

Tender ID.-2024\_MCGM\_1084227

## E-TENDER NOTICE

**Subject:** Rehabilitation of Malad WWTF - Treatment of Sewage Water by Bioremediation Technology.

The Brihanmumbai Municipal Corporation invites e-tender on Item Rate Basis to appoint Contractor for the aforementioned work from contractors of repute, multidisciplinary engineering organizations i.e. eminent firm, Proprietary/Partnership Firms / Private Limited Companies / Public Limited Companies / Companies registered under the Indian Companies Act 2013, the contractors registered with the Brihanmumbai Municipal Corporation in 'Class A' as per new registration and from the contractors / firms of equivalent or superior classes registered in Central or State Government / Semi Govt. Organization / Central or State Public Sector Undertakings will be allowed subject to condition that, the contractors who are not registered with Brihanmumbai Municipal Corporation will have to apply for registering their firm within three month time period from the award of contract, otherwise their Bid Security i.e. E.M.D (Earnest Money Deposit) will be forfeited / recovered and an amount equal to Registration Fee of respective class will be recovered as penalty.

The tender document can be downloaded from e-procurement system of Government of Maharashtra (Mahatenders portal) (<https://mahatenders.gov.in>)

Bidder shall pay scrutiny fee of Rs.27,500/- + 18% GST mentioned in header data as per the Circular no. CA/FRG/18 dated 27.02.2024 and CA/FRG/10 dated 19.10.2023 annexed in the tender document. The tender scrutiny fee shall be paid in cash only at any of the CFC centres in BMC ward offices after opening of Packet 'A' & 'B', before opening of packet 'C'.

Bidding Process will comprise of THREE stages.

Name and location of work	Contract period
Rehabilitation of Malad WWTF - Treatment of Sewage Water by Bioremediation Technology.	02 years (Inclusive of all seasonal conditions.)

In terms of the 3 stage system of e-tendering, a Bidder will be required to deposit, along with its Bid, an Earnest Money Deposit of Rs. 58,80,000/- (Rupees Fifty Eight Lacs Eighty Thousand Only) (the "EMD"), refundable in accordance to the relevant clause of bid document, from the Bid Due Date, except in the case of the selected Bidder whose Bid Security/EMD shall be retained.

The bidder shall pay 100% of the EMD amount of Rs. 58,80,000/- (Rupees Fifty Eight Lacs Eighty Thousand Only) through payment gateways of GoM on URL <https://mahatender.gov.in> while submitting the bids. The e-tender is available on e-procurement system of Government of Maharashtra Mahatenders portal <https://mahatenders.gov.in> as mentioned in the Header Data of the tender.

As per THREE Packet systems, the document for Packet 'A' & 'B' is to be uploaded online by the bidder in Cover Type 'Fee/Pre-Qual/Technical' and Price Packet 'C' is to be uploaded in Cover Type 'Finance'. Packet 'A', 'B' and 'C' shall be opened on dates as mentioned in header data. All the responsive and eligible bidders if they so wish can be present at the time of opening of bids, in the office of Deputy Chief Engineer (Sewerage Operations) Western Suburb. The Price Packet 'C' (Cover Type 'Finance') shall be opened if bids submission in Packet 'A' & 'B' satisfies/includes all the requirements and same are found acceptable to the Authority.

The Municipal Commissioner reserves the right to reject all or any of the e-tender(s) without assigning any reasons at any stage.

The dates and time for submission and opening the bids are as shown in the Header Data. If there are any changes in the dates the same will be displayed on the e-procurement system of Government of Maharashtra Mahatenders portal (<https://mahatenders.gov.in>)

The Applicants interested for the above referred works may contact the office of Executive Engineer (Sewerage Operations) Western Suburb at the following address on any working day during office hours.

Office of-

Executive Engineer Mechanical (Sewerage) W. Subs,  
Versova Sewage Pumping Station,  
Junction of J. P. Road & Link Road,  
Andheri (West), Mumbai-400 053.

The applicants may wish to visit the above office and can collect the information of the present status from the department who have invited the bids.

The BMC reserves the rights to accept any of the application or reject any or all the application received for above works, without assigning any reasons thereof. The information regarding above subject matter is available on e-procurement system of Government of Maharashtra (Mahatenders) (<https://mahatenders.gov.in>)

Bidders are also advised to refer "Bidders Manual Kit" available at e-Procurement System Government of Maharashtra ( <https://mahatenders.gov.in> ) for further details about login credentials and e-tendering process. For any help, in the e-Tendering process, can be availed by dialing help-desk number 022-22046934/22837339 from 11.30 AM to 5.00 PM on all working days. Email: [support-eproc@nic.in](mailto:support-eproc@nic.in)

Sd/-

**Deputy Chief Engineer  
(Sewerage Operations) Western Suburb**

## HEADER DATA

Tender ID	T-22/2024-25, Tender ID- 2024_MCGM_1084227
Name of Organization	Brihanmumbai Municipal Corporation
Subject	Rehabilitation of Malad WWTF - Treatment of Sewage Water by Bioremediation Technology.
Estimated Cost	Not Applicable (Item Rate Tender)
Scrutiny Fee	Rs.27,500.00+ 18%GST.
Bid Security Deposit/EMD	Rs.58,80,000/-
Date of issue and sale of tender	13.09.2024 from 11:00 Hrs
Date of Pre-Bid Meeting	20.09.2024 at 11:00 Hrs. under the Chairmanship of Ch.E.(SO) at 1 <sup>st</sup> Floor, Engineering Hub Building, Dr. E'Mozes Road, Worli, Mumbai – 400 018.
Last date & time for sale of tender	03.10.2024 up to 16:00 Hrs
Last date & time for Receipt of Bid Security Deposit/EMD	03.10.2024 up to 16:00 Hrs
Submission of Packet A, B & Packet C (Online)	03.10.2024 up to 16:00 Hrs
Opening of Packet A	04.10.2024 after 16:01 Hrs
Opening of Packet B	04.10.2024 after 16:02 Hrs.
Opening of Packet C	18.10.2024 after 15:00 Hrs.
Address for communication	Executive Engineer Mechanical (Sewerage) W. Subs Municipal Corporation of Greater Mumbai Versova Sewage Pumping Station, Junction of J.P.Road & Link Road, Andheri (West), Mumbai-400 053.Ph. No.: 022-26318728 Email : eemechsws.so@mcbgm.gov.in
Venue for opening of bid	On line in Executive Engineer Mechanical (Sewerage) W. Subs's office.

This tender document is not transferable.

The Brihanmumbai Municipal Corporation reserves the rights to accept any of the application or reject any or all the application received for above subject without assigning any reason thereof.

Sd/-  
**Deputy Chief Engineer**  
**(Sewerage Operations) Western Suburb**

**SECTION 2**  
**ELIGIBILITY CRITERIA**



## **A) Eligibility Criteria**

### **1. For Regular, Routine and Maintenance works:**

#### **1.1. Technical Capacity-**

(i) The tenderer shall be the Manufacturer of the microbial products they intend to offer for the subject work.

AND

(ii) The tenderer in their own name should have satisfactorily executed the work of similar nature in Brihanmumbai Municipal Corporation / Semi Govt. / Govt. & Public Sector Organizations during last seven (7) years ending last day of month previous to the one in which bids are invited as a prime Contractor (or as a nominated sub-Contractor, where the subcontract had involved similar nature of work as described in the scope of works in this bid document, provided further that all other qualification criteria are satisfied)

a) Three similar completed / Ongoing works each of capacity not less than 40 MLD.

Or

b) Two similar completed / Ongoing works each of capacity not less than 50 MLD.

Or

c) One similar completed / Ongoing works each of capacity not less than 80 MLD

In case of ongoing works to be considered, the bidder must have received the payment bills of 50% of the contract sum for the work / works executed last day of the month previous to the one in which bids are invited.

#### **1.2. Financial Capacity –**

Achieved an average annual financial turnover as certified by 'Chartered Accountant' equal to Rs. 17.64 Cr. in last three (3) financial years immediately preceding the financial year in which bids are invited.

- To ascertain this, tenderer(s) shall furnish / upload the financial statement (Audited Balance sheet) duly certified by Chartered Accountant.
- The turnover can be enhanced by 10% every year to bring the present level.

**1.3. Similar Experience:**

For assessing the technical capacity; Similar work shall mean, the completed or ongoing works in respect of **“Treatment of concentrated sewage in drains / concentrated sewage in Ponds / STPs in respect of reduction in BOD, COD, TSS and pH levels by Bioremediation Technology for continuous one year (12 months) inclusive of all seasonal conditions.”**

**B) Bid Capacity: (Not Applicable)**

The bid capacity of the prospective bidders will be calculated as under: Assessed Available Bid Capacity =  $(A * N * 2 - B)$

Where,

A = Maximum value of Civil Engineering works executed in any one year (year means Financial year) during the last five years (updated to the price level of the Financial year in which bids are received at a rate of 10% per year) taking into account the completed as well as works in progress.

N = Number of years prescribed for completion of the Project/Works, excluding monsoon period, for which these bids are being invited. (E.g. 7 months = 7/12 year) For every intervening monsoon 0.33 shall be added to N.

B = Value of existing commitments (only allotted works) on the last date of submission of bids as per bidding document and on-going works to be completed during the period of completion of the Project/Works for which these bids are being invited.

Note: The statement showing the value of existing commitments and on-going works as well as the stipulated period of completion remaining for each of the works listed should be attached along with certificates duly signed by the Engineer-in Charge, not below the rank of an Executive Engineer or equivalent.

**Even though the bidders meet the above qualifying criteria, they are subject to be disqualified if they have:**

- Made misleading or false representation in the forms, statements and attachments submitted in proof of the qualification requirements; and/or
- Record for poor performance such as abandoning the works, not properly completing the contract, inordinate delays in completion or financial failures etc.

**SECTION 3**  
**DISCLAIMER**

## **DISCLAIMER**

The information contained in this e-tender document or provided to Applicant(s), whether verbally or in documentary or any other form, by or on behalf of the Brihanmumbai Municipal Corporation (BMC), hereafter also referred as "The Authority", or any of its employees or advisors, is provided to Applicant(s) on the terms and conditions set out in this e-tender and such other terms and conditions subject to which such information is provided.

This e-tender includes statements, which reflect various assumptions and assessments arrived at by the Brihanmumbai Municipal Corporation (BMC) in relation to the Project. Such assumptions, assessments and statements do not purport to contain all the information that each Applicant may require. This e-tender may not be appropriate for all persons, and it is not possible for the Brihanmumbai Municipal Corporation (BMC), its employees or advisors to consider the investment objectives, financial situation and particular needs of each party who reads or uses this e-tender. The assumptions, assessments, statements and information contained in this e-tender may not be complete, accurate, adequate or correct. Each Applicant should therefore, conduct its own investigations and analysis and should check the accuracy, adequacy, correctness, reliability and completeness of the assumptions, assessments, statements and information contained in this e-tender and obtain independent advice from appropriate sources.

Information provided in this e-tender to the Applicant(s) is on a wide range of matters, some of which may depend upon interpretation of law. The information given is not intended to be an exhaustive account of statutory requirements and should not be regarded as a complete or authoritative statement of law. The Brihanmumbai Municipal Corporation (BMC) accepts no responsibility for the accuracy or otherwise for any interpretation or opinion on law expressed here.

The Brihanmumbai Municipal Corporation(BMC), its employees and advisors make no representation or warranty and shall have no liability to any person, including any applicant or Bidder, under any law, statute, rules or regulations or tort, principles of restitution or unjust enrichment or otherwise for any loss, damages, cost or expense which may

arise from or be incurred or suffered on account of anything contained in this e-tender or otherwise, including the accuracy, adequacy, correctness, completeness or reliability of the e-tender and any assessment, assumption, statement or information contained therein or deemed to form part of this e-tender or arising in any way with pre-qualification of Applicants for participation in the Bidding Process. The Brihanmumbai Municipal Corporation (BMC) also accepts no liability of any nature whether resulting from negligence or there wise howsoever caused arising from reliance of any Applicant upon the statements contained in this e-tender.

The Brihanmumbai Municipal Corporation (BMC) may, in its absolute discretion but without being under any obligation to do so, update, amend or supplement the information, assessment or assumptions contained in this e-tender.

The issue of this e-tender does not imply that the Brihanmumbai Municipal Corporation (BMC) is bound to select and short-list pre-qualified Applications for Bid Stage or to appoint the selected Bidder or Concessionaire, as the case may be, for the Project and the Brihanmumbai Municipal Corporation (BMC) reserves the right to reject all or any of the Applications or Bids without assigning any reasons whatsoever.

The Applicant shall bear all its costs associated with or relating to the preparation and submission of its Application including but not limited to preparation, copying, postage, delivery fees, expenses associated with any demonstrations or presentations which may be required by The Brihanmumbai Municipal Corporation (BMC) or any other costs incurred in connection with or relating to its Application. All such costs and expenses will remain with the Applicant and the Brihanmumbai Municipal Corporation(BMC) shall not be liable in any manner whatsoever for the same or for any other costs or other expenses incurred by an Applicant in preparation or submission of the Application, regardless of the conduct or outcome of the Bidding Process.

**SECTION 4**  
**INTRODUCTION**

## INTRODUCTION

### 1. Background:

The Brihanmumbai Municipal Corporation covers an area of 437.71sq.kms.with a population of **1.24 Crores as per census of 2011**. The metropolis accounts major portion of India's international trade and government's revenue, from being one of the foremost centers of education, science and technological research and advancement.

The Mumbai Metropolis has historic tradition of strong civic activism dedicated to the cause of a better life for all its citizens. And it's the Brihanmumbai Municipal Corporation, hereafter called the "Corporation", the primary agency responsible for urban governance in Greater Mumbai.

Brihanmumbai Municipal Corporation (The Authority) is one of the largest local self-governments in the Asian Continent. In observance of historic traditions of strong civic activism, with the change in time and living conditions to match with the urbanization, Brihanmumbai Municipal Corporation has mainly focused in providing almost all kinds of engineering services viz, Hydraulics, storm water drain, sewerage, water supply projects, roads, bridges, solid waste management, and environmental services. Beside this, the Brihanmumbai Municipal Corporation is also providing dedicated services in various segments such as Health, Primary Education as well as the construction and maintenance of Public Markets and Slaughter Houses.

Brihanmumbai Municipal Corporation is an organization having different departments, right from engineering depts. to health depts. Moreover we have other dept. like education, market, fire brigade dept., Octroi and other such departments where quite a good number of staff members are working.

Brihanmumbai Municipal Corporation is primarily an organization, which in the interest of citizens and with the speed of urbanization deals with the variety of the infrastructure services and delivered to the public by different departments like Water Supply Projects, Sewerage Projects, Hydraulics, Storm Water Drain/Roads and bridges and Building Construction etc.



**SECTION 5**

**E-TENDERING ONLINE  
SUBMISSION PROCESS**

## E-TENDERING ONLINE SUBMISSION PROCESS

The terminology of e-Tendering is solely depending upon policies in existence, guidelines and methodology adopted since decades. The e-Procurement System of Government of Maharashtra (Mahatenders) is only change in process of accepting and evaluation of tenders.

**NOTE:** This tendering process is covered under Information Technology ACT & Cyber Laws as applicable

- I. In e-tendering process some of the terms and its definitions are to be read as under wherever it reflects in online tendering process.

Start Date read as "Sale Date"

End Date read as "Submission Date"

Supplier read as "Contractor/bidder"

Vendor read as "Contractor/bidder"

Vendor Quotation read as "Contractors Bid/Offer"

Purchaser read as "Department/BMC"

- II. Before entering into the online tendering process, the bidders shall complete the registration process so as to get user ID for e-tendering links. For this the bidders can access through supply registration via e-procurement system of Government of Maharashtra (Mahatenders) i.e. <http://mahatenders.gov.in>

Interested bidders shall follow the manuals available on Mahatenders portal i.e. <http://mahatenders.gov.in>

- III. E-Tendering Process

1. Tender Forms can be downloaded from e - Procurement system of Government of Maharashtra i.e. <http://mahatenders.gov.in> after entering the details of payment toward Tender Fees as per the Header Data / tender notice.

2. The tender submitted by the tenderer shall be based on clarification, additional facility issued (if any) by the BMC, and this tender shall be unconditional. Conditional tenders will be summarily REJECTED.
3. All tenderers are cautioned that the tenders containing any deviation, from the contractual terms and conditions, specifications or other requirements, and conditional tenders will be rejected as non- responsive.
4. Tenderer should have valid class III digital signature certificates (DSC) obtained from any certifying Authorities. In case of requirements of DSC, interested Bidders should go to <http://mahatenders.gov.in>, information about DSC and follow the procedure mentioned in the document. Procedure for application of "Digital Signature Certificate".
5. Bidder should do Online Enrolment in e-procurement portal of Government of Maharashtra i.e. <https://mahatenders.gov.in> using the option Click Here to Enroll available in the Home Page. Then the Digital Signature enrolment has to be done with the e -token, after logging into the portal. The e-token may be obtained from one of the authorized Certifying Authorities such as e-MudhraCA /GNFC IDRBT MTNLTrustline /SafeScrip /TCS.
6. Bidder then logs into the portal giving user id / password chosen during enrolment.
7. The e-token that is registered should be used by the bidder and should not be misused by others.
8. DSC once mapped to an account cannot be remapped to any other account. It can only be inactivated.
9. The Bidders can update well in advance, the documents such as certificates, purchase order details etc., under My Documents option and these can be selected as per tender requirements and then attached along with bid documents during bid submission. This will ensure lesser upload of bid documents.

10. After downloading / getting the tender schedules, the Bidder should go through them carefully and then submit the documents as per the tender document, otherwise, the bid will be rejected.
11. The BOQ template must not be modified/replaced by the bidder and the same should be uploaded after filling the relevant columns, else the bidder is liable to be rejected for that tender. Bidders are allowed to enter the Bidder Name and Values only.
12. If there are any clarifications, this may be obtained online through the e-Procurement Portal, or through the contact details given in the tender document. Bidder should take into account of the corrigendum published before submitting the bids online.
13. Bidder, in advance, should prepare the bid documents to be submitted as indicated in the Header Data and they should be in PDF/XLS/RAR/DW F formats. If there is more than one document, they can be clubbed together.
14. Bidder should arrange for the EMD as specified in the tender.
15. The bidder reads the terms and conditions and accepts the same to proceed further to submit the bids.
16. The bidder has to submit the tender document (s) online well in advance before the prescribed time to avoid any delay or problem during the bid submission process.
17. There is no limit on the size of the file uploaded at the server end. However, the upload is decided on the Memory available at the Client System as well as the Network bandwidth available at the client side at that point of time. In order to reduce the file size, bidders are suggested to scan the documents in 75-100 DPI so that the clarity is maintained and also the size of file also gets reduced. This will help in quick uploading even at very low bandwidth speeds

18. It is important to note that, the bidder has to Click on the Freeze Bid Button, to ensure that he/she completes the Bid Submission Process. Bids Which are not Frozen are considered as Incomplete /Invalid bids and are not considered for evaluation purposes.
19. The Tender Inviting Authority (TIA) will not be held responsible for any sort of delay or the difficulties faced during the submission of bids online by the bidders due to local issues.
20. The bidder may submit the bid documents online mode only, through this portal. Offline documents will not be handled through this system.
21. At the time of freezing the bid, the e-Procurement system will give a successful bid updating message after uploading all the bid documents submitted and then a bid summary will be shown with the bid no, date & time of submission of the bid with all other relevant details. The documents submitted by the bidders will be digitally signed using the e-token of the bidder and then submitted.
22. After the bid submission, the bid summary has to be printed and kept as an acknowledgement as a token of the submission of the bid. The bid summary will act as a proof of bid submission for a tender floated and will also act as an entry point to participate in the bid opening event.
23. Successful bid submission from the system means, the bids as uploaded by the bidder is received and stored in the system. System does not certify for its correctness.
24. The bidder should see that the bid documents submitted should be free from virus and if the documents could not be opened, due to virus, during tender opening, the bid is liable to be rejected.
25. The time that is displayed from the server clock at the top of the tender Portal, will be valid for all actions of requesting bid submission, bid opening etc., in the e-Procurement portal. The Time followed in this portal is as per Indian Standard

Time (IST) which is GMT+5:30. The bidders should adhere to this time during bid submission.

26. All the data being entered by the bidders would be encrypted at the client end, and the software uses PKI encryption techniques to ensure the secrecy of the data. The data entered will not be viewable by unauthorized persons during bid submission and not viewable by any one until the time of bid opening. Overall, the submitted bid documents become readable only after the tender opening by the authorized individual.
  27. During transmission of bid document, the confidentiality of the bids is maintained since the data is transferred over secured Socket Layer (SSL) with 256 bit encryption technology. Data encryption of sensitive fields is also done.
  28. The bidders are requested to submit the bids through online e-Procurement system to the TIA well before the bid submission end date and time (as per Server System Clock).
  29. Bidder Manual Kit available on website <https://mahatenders.gov.in> for online payment of Tender Fee and EMD, submission of tender Packet 'A', 'B' and 'C', etc.
- IV. As per Three Packet system, the document for Techno-commercial Packet 'A' & 'B' are to be uploaded online by the bidder in Cover Type 'Fee/PreQual/Technical' and Price Packet 'C' is to be uploaded in Cover Type 'Finance' by the tenderer under 'Tender Covers'.
- V. The tenderer shall pay the EMD/Bid Security through payment gateways before submission of Bid and shall upload the screenshot of receipt of payment in Packet 'A' as per bidding schedule.
- VI. The e-tender is available on e-procurement system of Government of Maharashtra (Mahatenders) i.e. <http://mahatenders.gov.in>. The tenders duly filled in should be uploaded and submitted online on or before the end date of submission. The Packet 'A', Packet 'B' & Packet 'C' of the tenderer will be opened as per the time-table

shown in the Header Data in the office of Executive Engineer (Sewerage Operations) planning & Construction).

- VII. The Municipal Commissioner reserves the right to reject all or any of the e-Tender(s) without assigning any reason at any stage. The dates and time for submission and opening the tenders are as shown in the Header Data. If there are any changes in the dates the same will be displayed on the e-procurement portal, Government of Maharashtra i.e. <https://mahatenders.gov.in>

**SECTION 6**  
**INSTRUCTIONS TO APPLICANTS**



## INSTRUCTIONS TO APPLICANTS

### ➤ **Scope of Application**

The Authority wishes to receive Applications for Qualification in order to SELECT experienced and capable Applicants for the Bid Stage.

#### **A. Equipment Capabilities as required for this work**

- a) **Regular and Routine works** :The successful bidder will make the arrangements of the required equipment on the day of commencement or with respect to the progress of the work in phases, as per the instructions of site in charge. The successful bidder and, to that effect he will ensure commitment on an undertaking on Rs. 500 stamp paper to be submitted along with the Bid in Packet B. However, this condition in no way shall dilute the respective condition in Registration Rules of BMC.

**Note:** Bidders shall submit the undertaking for equipment capability and other undertakings as such on a single Rs. 500/- stamp paper

#### **b) New and Original Works :(Not Applicable)**

The bidder should, undertake their own studies and furnish with their bid, a detailed construction planning and methodology supported with assessment study of requirements of equipment/plants & machineries to allow the employer to review their proposal. The bidder will ensure his commitment to make the arrangements of the required equipment on the day of commencement or with respect to the progress of the work in phases, as per the instructions of site in charge on an undertaking on Rs.500 stamp paper to be submitted along with the Bid in Packet B. However, this condition in no way shall dilute the respective condition in Registration Rules of Brihanmumbai Municipal Corporation.

**Note:** Bidders shall submit the undertaking for equipment capability and other undertakings as such on a single Rs. 500/- stamp paper.

**B. Technical Personnel**

Number of Technical Staff required for successful execution of the work shall be provided by the successful bidder. The details of required experienced technical personnel and penalisation in case of failure in providing these experienced technical personnel are as given but not limited to the followings.

**Requirement of Technical Staff –**

The system shall be monitored 24x7 throughout the contract period. The successful contractor shall provide the following manpower - Technical, Supervising and Monitoring Staff:

Sr. No.	Manpower Required	Qualification	Nos.
1	Technical	Graduate / Post Graduate in Environmental Science / Engineering	01
2	Supervising	Graduate in any field	01 in each shift of 08 hours
3	Labour	-	01 in each shift of 08 hours

**C. TIME PERIOD OF THE PROJECT:**

Entire project should be completed and delivered within **02 years** from the date of award of contract inclusive of all seasonal conditions.

The time allowed for carrying out the work as entered in the Tender shall be strictly observed by the Contractor and shall be reckoned from the date on which the Letter of Acceptance is given to the Contractor. The work shall throughout the stipulated period of the Contract be proceeded with all due diligence as time being deemed to be the essence of the contract on the part of the Contractor. On failing to do so, the Contractor shall pay as compensation an amount which shall be governed as per Clause - 84 of General Conditions of Contract.

The programme for completion of work shall be a part of the Contract Document in the form of Bar Chart / GANTT Chart. The Contractor is supposed to carry out the work and keep the progress as per Bar Chart/GANTT Chart. The Contractor shall complete the work as per the Schedule given in the Contract and the programme submitted by the Contractor.

**D. Contract Execution**

All required documents for execution of the contract shall be submitted within 30 days from the date of issue of letter of acceptance. If the documents are not submitted within the stipulated time, a penalty of Rs 5000/- per day will be applicable to the contractor. All contract documents need to be duly affixed with stamp duty properly signed along with evidence/proof of payment of security/contract deposit/ within 30 days from the date of letter of acceptance received by him

**E.** If the amount of the Contract Deposit to be paid above is not paid within 30 days from the date of issue of Letter of Acceptance, the Tender / Contract already accepted shall be considered as cancelled and legal steps be taken against the contractor for recovery of the amounts.

**F.** The amount of Security Deposit retained by the Brihanmumbai Municipal Corporation shall be released after expiry of period up to which the contractor has agreed to maintain the work in good order is over. In the event of the contractor failing or neglecting to complete the rectification work within the period up to which the contractor has agreed to maintain the work in good order, the amount of security deposit retained by Brihanmumbai Municipal Corporation shall be adjusted towards the excess cost incurred by the Department on rectification work.

**G. Action when whole of security deposit is forfeited:**

In any case in which under any Clause of this contract, the contractor shall have rendered himself liable to pay compensation amounting to the whole of this security deposit whether paid in one sum or deducted by instalments or in the case of abandonment of the work owing to serious illness or death of the contractor or any

other cause, the Engineer on behalf of the Municipal Commissioner shall have power to adopt any of the following process, as he may deem best suited to the interest of Brihanmumbai Municipal Corporation -

- (a) To rescind the contract (for which recession notice in writing to the contractor under the head of Executive Engineer shall be conclusive evidence) and in that case, the security deposit of the contract shall stand forfeited and be absolutely at the disposal of Brihanmumbai Municipal Corporation.
- (b) To carry out the work or any part of the work departmentally debiting the contractor with the cost of the work, expenditure incurred on tools and plant, and charges on additional supervisory staff including the cost of work-charged establishment employed for getting the un-executed part of the work completed and crediting him with the value of the work done departmentally in all respects in the same manner and at the same rates as if it had been carried out by the contractor under the terms of his contract. The certificate of the Executive Engineer as to the costs and other allied expenses so incurred and as to the value of the work so done departmentally shall be final and conclusive against the contractor.
- (c) To order that the work of the contractor be measured up and to take such part thereof as shall be un-executed out of his hands, and to give it to another contractor to complete, in which case all expenses incurred on advertisement for fixing a new contracting agency, additional supervisory staff including the cost of work charged establishment and the cost of the work executed by the new contract agency will be debited to the contractor and the value of the work done or executed through the new contractor shall be credited to the contractor in all respects and in the same manner and at the same rates as if it had been carried out by the contractor under the terms of his contract. The certificate of the Executive Engineer as to all the cost of the work and other expenses incurred as aforesaid for or in getting the un-executed work done by the new contractor and as to the value of the work so done shall be final and conclusive against the contractor.

In case the contract shall be rescinded under Clause (a) above, the contractor shall not be entitled to recover or be paid any sum for any work therefore actually performed by him under this contract unless and until the Executive Engineer shall have certified in writing the performance of such work and the amount payable to him in respect thereof and he shall only be entitled to be paid the amount so certified. In the event of either of the courses referred to in Clause (b) or (c) being adopted and the cost of the work executed departmentally or through a new contractor and other allied expenses exceeding the value of such work credited to the contractors amount of excess shall be deducted from any money due to the contractor, by Brihanmumbai Municipal Corporation under the contract or otherwise, howsoever, or from his security deposit or the sale proceeds thereof provided, however, the contractor shall have no claim against Brihanmumbai Municipal Corporation even if the certified value of the work done departmentally or through a new contractor exceeds the certified cost of such work and allied expenses, provided always that whichever of the three courses mentioned in clauses (a), (b) or (c) is adopted by the Executive Engineer, the contractor shall have no claim to compensation for any loss sustained by him by reason of his having purchase or procured any materials or entered in to any engagements or made any advance on account of or with a view to the execution of the work or the performance of the contract.

**H. Contract may be rescinded and security deposit forfeited for bribing a public officer or if contractor becomes insolvent**

If the contractor assigns or sublets his contracts or attempt so to do, or become insolvent or commence any proceeding to get himself adjudicated and insolvent or make any composition with his creditors, or attempt so to do or if bribe, gratuity, gift, loan, perquisite, reward or advantage, pecuniary or otherwise, shall either directly or indirectly be given promised or offered by the contractor or any of his servants or agents through any public officer, or person in the employ of Brihanmumbai Municipal Corporation /Govt. in any way relating to his office or employment, or if any such officer or person shall become in any way directly or

indirectly interested in the contract the Engineer In-charge may thereupon, by notice in writing rescind the contract and the Security Deposit of the Contractor shall thereupon stand forfeited and be absolutely at the disposal of Brihanmumbai Municipal Corporation and the same consequences shall ensue as if the contract had been rescinded under above clause J hereof; and in addition the contractor shall not be entitled to recover or be paid for any work therefore actually performed under the contract.

## Submission of Tenders

### PACKET - A

**The Packet 'A' shall contain scanned certified copies of the following documents.**

Scrutiny of this packet will be done strictly with reference to only the scanned copies of Documents uploaded online in packet 'A'

- a) Valid Registration Certificate.
- b) **Valid Bank Solvency Certificate** (in Hindi / Marathi / English) of Minimum Solvency amount of Rs. **8 Lakh** as governed by Registration Rules in force for respective Class of Contractor for M&E works from the scheduled / nationalized Bank in the name of firm / company granted not prior to twelve months of due date of tender.
- c) A document in support of Registration under 'Goods & Service Tax Act, 2017. Those not registered shall submit an undertaking to the effect that if they are successful tenderer, they shall submit GST Registration Certificate within 15 days of issue of work order, failing which payment for the work executed will not be released.
- d) Certified copies of valid 'PAN' documents and photographs of the individuals, owners, Karta of Hindu undivided Family, firms, private limited companies, registered co-operative societies, partners of partnership firms and at least two Directors, if number of Directors are more than two in case of Private Limited Companies, as the case may be. However, in case of Public Limited companies, Semi Government Undertakings, Government Undertakings, no 'PAN' documents will be insisted.
- e) Latest Partnership Deed in case of Partnership firm duly registered with Chief Accountant of BMC.
- f) The registered power of attorney in the name of person submitting the bid duly registered with Chief Accountant of BMC.

**The bidders shall categorically provide their Email-ID in packet 'A'.**

**NOTE:**

- i) If the tenderer(s) withdraw tender offer during the tender validity period, his entire E.M.D shall be forfeited.
- ii) If it is found that the tenderer has not submitted required curable documents in Packet "A" then, the shortfalls will be communicated to the tenderer through e-mail only and compliance required to be made within a time period of **Three working days** otherwise they will be treated as non-responsive.

**PACKET - B**

**The Packet 'B' shall contain scanned certified copies of the following documents -**

- a) The list of similar type of works as stated in para 'A' of Post qualification successfully completed during the last seven years in prescribed proforma, in the role of prime contractor. Information furnished in the prescribed Proforma (Proforma – I & Proforma - III) shall be supported by the certificate duly self-attested.
- b) Annual financial turnover for preceding three financial years as certified by Chartered Accountant preceding the Financial Year in which bids are invited. Copies of Applicants duly audited balance sheet and profit and loss account for the preceding three financial years preceding the Financial Year in which bids are invited. (Proforma - II)
- c) Documents stating that, it has access to or has available liquid assets, unencumbered assets, lines of credit and other financial means (independent of any contractual advance payment) sufficient to meet the construction cash flow requirements for the subject contract in the event of stoppage, start-up, or other delay in payment, of the minimum 15% of the cost of the work tendered for, net of the tenderer's commitment of other contracts (Certificate from Bankers / C.A./Financial Institution shall be accepted as a evidence).



- d) The bidder shall give undertaking on Rs 500/- stamp paper that it is his / their sole responsibility to arrange the required machineries either owned/on lease or hire basis, at site before start of the work.

**i) Regular and Routine works:**

The successful bidder shall make the arrangements of the required equipment on the day of commencement or with respect to the progress of the work in phases, as per the instructions of site in charge. The successful bidder and, to that effect he will ensure commitment on an undertaking on Rs.500 stamp paper to be submitted along with the Bid in Packet B. However, this condition in no way shall dilute the respective condition in Registration Rules of Brihanmumbai Municipal Corporation.

Note: Bidders shall submit the undertaking for equipment capability and other undertakings as such on a single Rs. 500/- stamp paper

**ii) New and Original Works: (Not Applicable)**

The bidder should, undertake their own studies and furnish with their bid, a detailed construction planning and methodology supported with assessment study of requirements of equipment/plants & machineries to allow the employer to review their proposal. The bidder shall ensure his commitment to make the arrangements of the required equipment on the day of commencement or with respect to the progress of the work in phases, as per the instructions of site in charge on an undertaking on Rs.500 stamp paper to be sub-mitted along with the Bid in Packet B. However, this condition in no way shall dilute the respective condition in Registration Rules of Brihanmumbai Municipal Corporation.

- e) Details of works in hand (Proforma VI-A & VI-B) (original), along with copies of work orders & attested copies of percentage of works completed or part thereof.
- f) Information on Litigation History in prescribed Proforma -VII.
- g) Proforma IV- Personnel Details and Proforma V/A and V/B – Machinery
- h) Statement showing assessed available Bid Capacity.

- i) The undertaking of Rs.500/- stamp paper as per the proforma annexed in 'Annexure B, C&E and Status of Bidder as per 'Annexure F'.

**Note:** Bidders shall submit the undertaking for equipment capability and other undertakings as such on a single Rs.500/- stamp paper.

- j) The tenderer(s) shall upload work plan as per the following outline:
1. GANTT chart/ PERT/ CPM chart showing the completion of work within prescribed time period, considering major activities.
  2. Organizational set up envisaged by the contractors.
  3. Plant & equipment proposed to be deployed for this work.
  4. Site Offices and Laboratories proposed to be set up.
  5. A note on how the whole work will be carried out (work plan including methodology).
  6. Quality management plan.
  7. All the activities included in the Scope of Work shall be covered in the work plan.

**Note:**

- i) The Electrical / Mechanical work shall be got carried out by the civil contractors through the contractors registered with Brihanmumbai Municipal Corporation in Electrical Category. Information about the registered contractors shall be obtained from the office of the Ch.E. (M&E) / E.E. (Monitoring &Registration Cell). Attested scanned copy of the valid registration certificate in Electrical Category shall be uploaded with the tender along with the undertaking from the registered Electrical Contractor stating his willingness to carry out the tender work.
- ii) The successful bidder shall submit valid registration certificate under E.S.I.C., Act 1948, if the tenderer has more than 10 employees /persons on his establishment (in case of production by use of energy) and 20 employees/persons on his

establishment (in case of production without use of energy) to Brihanmumbai Municipal Corporation as and when demanded. In case of less employees/persons mentioned above then the successful bidder has to submit an undertaking to that effect on Rs. 200 stamp paper as per circular u/no. CA/FRD/I/65 of 30.03.2013.

- iii) The successful bidder shall submit valid registration certificate under E.P.F. & M.P., Act 1952, if tenderer has more than 20 employees/persons on his establishment, to Brihanmumbai Municipal Corporation as and when demanded. In case if the successful bidder has less employees/persons mentioned above then the successful bidder has to submit an undertaking to that effect on Rs. 200 stamp paper as per circular u/no. CA/FRD/I/44 of 04.01.2013.

**Note:**

- If it is found that the tenderer has not submitted required documents in Packet “B” then, the shortfalls will be communicated to the tenderer through e-mail only and compliance required to be made within a time period of **three working days** otherwise they will be treated as non-responsive.

**PACKET – C**

**Interested bidders shall follow the manuals available on Mahatenders Portal <http://mahatenders.gov.in> for submission of Price Packet ‘C’ in cover type ‘Finance’**

The tenderer should quote and upload his offer through only bidding process in the form of Bill of Quantity in terms of Item rates in Cover Type ‘Finance’ as per the guidelines provided in Mahatenders portal. He should not quote his offer anywhere directly in Cover Type ‘Fee/PreQual/Technical’ . The tenderer shall quote for the work as per details given in the main tender and also based on the detailed common set of conditions issued / additional stipulations made by the department as informed by BMC after Pre-Bid Meeting.

**Note:** In case of rebate/premium of 15% and above as quoted by the tenderer, the rate analysis of major items shall be submitted by L1 and L2 bidder after demand notification by e-mail to bidders by concerned Executive Engineer / Deputy Chief Engineer. The format for rate analysis is annexed at Annexure D.

### **BID SECURITY OR EMD**

- The Bidder shall furnish, as part of the Bid, Bid Security/EMD, via online payment gateway mode in the amount specified in the Bid Data Sheet. This bid security shall be in favour of the authority mentioned in the Bid Data Sheet and shall be valid till the validity of the bid.
- The bidder shall pay 100% of the EMD amount through payment gateways of GoM on URL <https://mahatender.gov.in> while submitting the bids. The e-tender is available on e-procurement system of Government of Maharashtra Mahatenders portal <https://mahatenders.gov.in> as mentioned in the Header Data of the tender.
- Any bid not accompanied by an acceptable Bid Security and not secured as indicated in sub-clause mentioned above, shall be rejected by the Employer as non-responsive.
- The Bid Security/EMD of the successful Bidder will be discharged when the Bidder has signed the Agreement and furnished the required Security Deposits as mentioned in circular issued by CA(F) u/n CA(F)/Project/32/ dtd.26.10.2020.
- The Bid Security/ EMD of L-2 and higher bidders (L-3, L-4, etc.) shall be refunded immediately after opening of financial bid (as per circular CA/F/32 dtd. 26.10.2020) and as per prevailing practice of NIC portal <https://mahatender.gov.in>
- In case, the successful bidder becomes non responsive or successful bidder withdraws the bid or is unwilling to extend the bid validity period, in such circumstances, if L-2 bidder is agreeable to extend the bid validity period and ready to deposit the requisite amount of bid security /EMD to the department within the stipulated time period i.e. 15 days, the department will process further as per

normal procedure as mentioned in circular issued by CA(F) u/n CA(F)/Project/32/ dtd.26.10.2020.

- The Bid Security may be forfeited:
  - a) if the Bidder withdraws the Bid after bid opening (opening of technical qualification part of the bid during the period of Bid validity;
  - b) in the case of a successful Bidder, if the Bidder fails within the specified time limit to:
    - i. sign the Agreement; and/or
    - ii. Furnish the required Security Deposits.
- The information of e-payment gateway is available on e-tendering website <https://mahatenders.gov.in>.

**Note:**

1. The cases wherein if the shortfalls are not complied by a contractor, will be informed to Registration and Monitoring Cell. Such non-submission of documents will be considered as 'Intentional Avoidance' and if three or more cases in 12 months are reported, shall be viewed seriously and disciplinary action against the defaulters such as banning/de-registration, etc. shall be taken by the registration cell with due approval of the concerned AMC.
2. The bidder shall refer latest EMD circular for curable and non-curable defects u/no.CA/Finance/19 dt.04.03.2024 .

**Note:**

- i) **Curable Defect shall mean shortfalls in submission such as:**
  - a) **Non-submission of following documents,**
    - i) **Valid Registration Certificate**
    - ii) **Valid Bank Solvency**
    - iii) **GST Registration Certificate**
    - iv) **Certified Copies of PAN documents and photographs of individuals, owners, etc.**
    - v) **Partnership Deed and any other documents**

**vi) Undertakings as mentioned in the tender document**

**b) Non-curable Defect shall mean**

- i) In-adequate submission of EMD/ASD amount,**
- ii) In-adequacy of technical and financial capacity with respect to Eligibility criteria as stipulated in the tender.**
- iii) Wrong calculation of Bid Capacity,**
- iv) No proper submission of experience certificates and other documents, etc.**

### **BID VALIDITY**

- **Bids shall remain valid for a period of not less than one eighty (180) days after the deadline date for bid submission specified in Bid Data Sheet. A bid valid for a shorter period shall be rejected by the Employer as non-responsive.**
- In exceptional circumstances, prior to expiry of the original time limit, the Employer may request that the bidders may extend the period of validity for a specified additional period. The request and the bidders' responses shall be made in writing or by cable. A bidder may refuse the request without forfeiting his Bid Security. A bidder agreeing to the request will not be required or permitted to modify his bid, but will be required to extend the validity of his bid security for a period of the extension.

### **DEFECT LIABILITY PERIOD**

- The Contractor is expected to carry out the construction work in Workmen like manner so as to meet the requirement and specification for the project. It is expected that the Workmanship and materials will be reasonably fit for the purpose for which they are required.
- Defects or defective work is where standard and quality of workmanship and materials as specified in the contract is deficient. Defect is defined as a failure of the

completed project to satisfy the express or implied quality or quantity obligations of the construction contract. Defective construction works are as the works which fail short of complying with the express descriptions or requirements of the contract, especially any drawings or specifications with any implied terms and conditions as to its quality, workmanship, durability, aesthetic, performance or design. Defects in construction projects are attributable to various reasons.

- Some of the defects are structural defects results in cracks or collapse of faulty defective plumbing, inadequate or faulty drainage system, inadequate or faulty ventilation, cooling or heating systems, inadequate fire systems etc. The defects could be various on accounts of different reasons for variety of the projects.
- The Engineering In charge/Project Officer shall issue the practical completion certificate for the project. During the Defect Liability Period which commences on completion of the work, the Engineering In charge shall inform or the contractor is expected to be informed of any defective works by the Employer's representative of the defects and make good at contractor's cost with an intention of giving opportunity to the contractor of making good the defects appeared during that period. It is the contractor's obligation under the contract to rectify the defects that appear during Defect Liability Period and the contractor shall within a reasonable time after receipt of such instructions comply with the same at his own cost. The Engineering In charge/Project Officer shall issue a certificate to that effect and completion of making good defects shall be deemed for all the purpose of this contract to have taken place on the day named in such defect liability certificate.
- If defective work or workmanship or design have been knowingly covered-up or concealed so as to constitute fraud, commencement of the Defect Liability Period may be delayed. The decided period may be delayed until discover actually occurs on at least the defect could have been discovered with reasonable diligence, whichever is earlier.
- **The Defect Liability Period (DLP) for the work – (Not Applicable)**

- Also, in case of defect, the Engineer shall give notice to the Contractor of any Defects before the end of the Defects Liability Period, which begins at. The Defects Liability Period shall be extended for as long as Defects remain to be corrected. Every time notice of Defect/Defects is given, the Contractor shall correct the notified Defect/Defects within the duration of time specified by the Engineer's notice. The Engineer may issue notice to the Contractor to carry out removal of defects or deficiencies, if any, noticed in his inspection, or brought to his notice. The Contractor shall remove the defects and deficiencies within the period specified in the notice and submit to the Engineer a compliance report.
- It is the Completion Stage when the contractor has completed all of the works and fixed all of the defects that were on the list of issue by Engineer-in-charge. When this happens, the engineer must issue a 'Certificate of Completion'. On the issue of 'Certificate of Completion', the 'Defect Liability Period' starts. The contractor also must issue a 'Certificate statement' as an acknowledgment to the engineer not later than 14 days after the 'Certificate of Completion' has been issued. During the 'Defect Liability Period', the contractor has to obey all written instructions from the engineer to carryout repairs and fix any defects which appear in the Permanent Works. If the contractor does not ,due to his own faults finish the repair works or fix the defects by the end of 'Defect Liability Period', the 'Defect Liability Period' will continue until all works instructed by engineer is done.



## SECURITY DEPOSIT AND PERFORMANCE GUARANTEE

### A. Security Deposit

The security deposit shall mean and comprise of

- I) Contract Deposit and
- II) Retention Money.

I) **Contract Deposit** - The successful tenderer, hereafter referred to as the contractor shall pay an amount equal to **two (2)** percent of the contract sum as a Contract Deposit within thirty days from the date of issue of letter of acceptance.

II) **Retention Money (Not Applicable)** - The contractor shall pay the retention money an amount equal to **five (5)** percent of the Contract Sum which will be recovered from the contractors every bill i.e. interim / running / final bill. The clause of retention money will not be applicable M.& E. Department.

### B. Additional Security Deposit (Not Applicable)

1. If the lowest bidder quotes rebate less than 12%, then the applicable additional security deposit (ASD) at the rate of 1% for each percentage quoted below 12% will not require to be paid online while submission of tender online.
2. After sanction/approval of competent authority to the contract cost, the lowest bidder shall deposit ASD in the Municipal Citizen Facility Centres in the form of Demand Draft as mentioned in Letter of Acceptance (LOA) within 15 working days as per prevailing practice and the receipt of the same shall be submitted to Head of the Department.
3. If the first lowest bidder will not paid ASD within 15 working days after issue of LOA, then the EMD paid by the concerned company will be forfeited and the company will be debarred for two years, similarly if the Director/Partner of the company is also working in other company as a Director/Partner, then said company will also be debarred for two years.

4. The ASD shall be paid as per the circular u/no. CA(Finance)/42 dated. 09.02.2021 annexed in tender document.

**C. Performance Guarantee**

The successful tenderer, hereafter referred to as the contractor shall pay in the form of “Performance Guarantee” at different rates for different slabs as stated below:

Offer	PG applicable %
For premium, at par and rebate 0 to 12%	$PG = 0.92\% \times \text{contract sum applicable for rebate of } 12\%$
For rebate of 12.01% and more	$P.G. = \{0.92\% \times \text{contract sum applicable for rebate of } 12\% \} + (X) \times \text{contract sum}$ where, X= percentage rebate quoted more than 12%

**Note:** Contract sum shall mean amount after application of rebate/premium as quoted by the contractor with contingencies only and excluding price variation.

The PG shall be paid in one of the following forms.

- I) Cash (In case guarantee amount is less than Rs.10,000/-)
- II) Demand Draft (In case guarantee amount is less than Rs.1,00,000/-)
- III) Government securities
- IV) Fixed Deposit Receipts (FDR) of a Schedule Bank.
- V) An electronically issued irrevocable bank guarantee bond of any Schedule bank or in the prescribed form Annexed in tender document.

Performance Guarantee is applicable over and above the clause of Security Deposit. Performance Guarantee will have to be paid & shall be valid till the defect liability period or finalization of final bill whichever is later.

This deposit will be allowed in the form of I to V as mentioned above and shall be paid within 15 days after receipt of Letter of Acceptance.

**Note:** Following exceptions shall be adopted for 'Demolition Tenders':

- Irrespective of the offer (Rebate/ at par/ premium), ASD shall be differed and only PG of 10% of contract sum be taken from the successful bidder on award of contract only.
- Brihanmumbai Municipal Corporation departments shall ensure to incorporate specific condition regarding above in bid document and e-tender notice.

**D. Refund of Security Deposit**

**I. Refund of Contract Deposit**

The Contract Deposit shall be released within 30 days after completion of 3<sup>rd</sup> year of DLP (in case of 5 years DLP) and after issue of 'Defect Liability Certificate' (in case of 1 or 2 or 3 years DLP) subject to no recoveries are pending against the said work, provided that the Engineer is satisfied that there is no demand outstanding against the Contractor. No claim shall be made against the Balance Contract Deposit after the issue of Defects Liability Certificate.

**II. Refund of Retention Money (Not Applicable)**

One-half (50%) of the Retention Money shall be released within 30 days of issue of 'Certificate of Completion' with respect to the whole of the Works. In the event the Engineer issues a Taking-over Certificate for a section or part of the Permanent Works, only such proposition thereof as the Engineer determines (having regard to the relative value of such section or part of the Works) shall be considered by the Engineer for payment to the Contractor.

The balance Retention Money shall be released within 30 days after completion of 3<sup>rd</sup> year of DLP (in case of 5 years DLP) and after issue of 'Defect Liability Certificate' (in case of 1 or 2 or 3 years DLP) provided that the Engineer is satisfied that there is no demand outstanding against the Contractor. In the event of different Defects Liability Periods have been specified or become applicable to different sections or parts of the Permanent Works, the said moneys will be released within 30 days on expiration of the latest of such Defects Liability Periods.

Payment of the above mentioned 50% is exclusive of the amounts to be withheld as stated in and that amount shall be paid as per condition stated therein.

**i. Refund of Additional Security Deposit (Not Applicable)**

The additional security deposit shall be released within 30 days of issue of 'Certificate of Completion' with respect to the whole of the Works. In the event the Engineer issues a Taking-over Certificate for a section or part of the Permanent Works, only such proportion thereof as the Engineer determines (having regard to the relative value of such section or part of the Works) shall be considered by the Engineer for payment to the Contractor.

**III. Refund of Performance Guarantee**

The Deposit on account of performance guarantee shall be released within 30 days of completion of Defects Liability Certificate subject finalization of final bill whichever is later and no recoveries are pending against the said work, provided that the Engineer is satisfied that there is no demand outstanding against the Contractor.

❖ **Summary of time of Refund of deposit is tabulated as follows:**

- a) Time of Refund for works having 5 years DLP

Deposits refunded after Completion	After 3 yrs of DLP	After Completion of DLP
ASD + 50% of RM	CD+50% of RM	PG

b) Time of Refund for works having 1 or 2 or 3 years DLP

Deposits refunded after completion	After Completion of DLP
ASD + 50% of RM	CD+50% of RM+PG

**\*Note:**

- a) It shall be clearly mentioned that the BG shall be applicable for individual work/contract and clubbing of various contracts of the said contractor will not be allowed. In case of obtaining Bank Guarantee, it is necessary to mention that the same shall be valid further 6 months from the completion of defect liability period/ warranty period.
- b) It shall be the responsibility of the bidder to keep the submitted B.G. "VALID" for the stipulated time period in the tender & in case of its expiry it will attract penalization.
- c) Bank Guarantee should be issued by way of General Undertaking and Guarantee issued on behalf of the Contractor by any of the Nationalized or Scheduled banks or branches of foreign banks operating under Reserve Bank of India regulations located in Mumbai uptoVirar&Kalyan. List of approved Banks is appended at the end of Instructions to Bidders (ITB). The Bank Guarantee issued by branches of approved Banks beyond Kalyan and Virar can be accepted only if the said Bank Guarantee is countersigned by the Manager of a Regional Branch of the same bank within the Mumbai City Limit categorically endorsing thereon that the said Bank Guarantee is binding on the endorsing Branch of the Bank or the Bank itself within Mumbai Limits and is liable to be enforced against the said Branch of the Bank or the bank itself in case of default by

the Contractors furnishing the Bank Guarantee. The Bank Guarantee shall be renewed as and when required and/or directed from time to time until the Contractor has executed and completed the works and remedied any defects therein.

**E. Legal + Stationary Charges:**

Successful tenderer shall pay the Legal Charges + Stationary charges as per Circular no.26206 dated 31.08.2023 Annexed in the tender document or latest circular in this regards.

The tenderers are requested to note that stationary charges as given in the circular will be recovered from the successful tenderer for supply of requisite prescribed forms for preparing certificate bills in respect of the work.

**F. Stamp Duty: (As per latest applicable circular)**

It shall be incumbent on the successful tenderer to pay stamp duty on the contract.

- i. As per the provision made in Article 63, Schedule I of Bombay Stamp Act 1958, stamp duty is payable for “works contract” that is to say, a contract for works and labour or services involving transfer of property in goods (whether as goods or in some other form) in its execution and includes a sub-contract, as under :

(a)	Where the amount or value set forth in such contract does not exceed rupees ten lakh.	Five Hundred rupees stamp duty
(b)	Where it exceeds rupees ten lakhs	Five hundred rupees plus 0.1% of the amount above Rs. 10,00,000/- subject to the maximum of rupees twenty five lakh stamp duty.
(c)	Bank guarantee: As per article 54 read with 40(b) of stamp duty	

	act, stamp duty of 0.5% will be applicable to the all bank guarantee submitted also which are required to be renewed after expiry of time period.
--	---

- ii. The successful bidder shall enter into a contract agreement with BMC within 30 days from the date of issue of Work Order and the same should be adjudicated for payment of Stamp Duty by the successful bidder.
- iii. Further shortfall if any, in amount of stamp duty paid as against prescribed amount for the documents executed in Mumbai City & Mumbai Suburban District be recovered from the concerned work contractors and to deposit the deficit or unpaid Stamp Duty and penalty by two separate Demand Draft or Pay Order in favour of "Superintendent of Stamp, Mumbai" within 15 days from intimation thereof.
- iv. All legal charges and incidental expenses in this respect shall be borne and paid by the successful tenderer.

## IMPORTANT DIRECTIONS

1. All the information uploaded shall be supported by the corroborative documents in absence of which the information uploaded will be considered as baseless and not accepted for qualification criteria. All the documents shall be uploaded with proper pagination. The page No. shall be properly mentioned in the relevant places.

The information shall be uploaded in the sequence as asked for with proper indexing etc. The Bidder shall be fully responsible for the correctness of the information uploaded by him.

2. TENDERERS ARE REQUESTED TO GO THROUGH THE e- TENDER GUIDELINES ON NIC PORTAL (<https://mahatenders.gov.in>). For registration, enrolment for digital signature certificate & user manual, please refer to respective links provided in e-tendering tab. The vendors can get digital signature from any one of the Certifying Authorities (CA's) licensed by the Controller of Certifying Authorities namely Safes crypt, IDRBT, National Informatics Centre, TCS, Customs, MTNL, GNFC and e- Mudhra.

Any queries or request for additional information concerning this TENDER shall be submitted by e-mail to [eemechsws.so@mcgm.gov.in](mailto:eemechsws.so@mcgm.gov.in). The subject shall clearly bear the following identification/ title: "Queries/ Request for Additional Information: TENDER for (Tender Subject)". Any changes in mail ID will be intimated on the portal.

3. In case of Equal percentage of lowest bidders (L1), the allotment of work shall be done by giving 48 hrs (2 working days) from the day of opening of packet C on same BID-Document number for re-quoting and such development needs to be done by IT department in Brihanmumbai Municipal Corporation's SRM system. Till such development is made; 'Sealed Bids' shall be called from the bidders quoting the same percentage i.e. L1.

In case of equal percentage of lowest bidders is obtained even after re-quoting, then the successful bidder will be decided by lottery system by concerned Chief Engineer.

The bidder shall need to submit the additional ASD if applicable within 15 days after receipt of notification issued by concerned Chief Engineer.



Also, the Performance Guarantee shall be paid in 15 days after receipt of Letter of Acceptance.

**4. Notwithstanding Joint Venture is not allowed in the instance tender.**

5. GST and other state levies/cess which are not subsumed under GST will be applicable. The tenderer shall quote inclusive of all taxes applicable at the time of bid submission. It is clearly understood that BMC will not bear any additional liability towards payment of any Taxes & Duties.

Wherever the services to be provided by the Tenderers, falls under Reverse Charge Mechanism, the Price quoted shall be exclusive of GST, but inclusive of Taxes/Duties/Cess other than GST, if any.

Rates accepted by BMC shall hold good till completion of work shall be admissible on account of fluctuations in market rates; increase in taxes/any other levies / tolls etc. except that payment/recovery for overall market situation shall be made as per Price variation and if there is any subsequent change (after submission of bid) in rate of GST applicable on the work/services to be executed as per tender, i.e. any increase will be reimbursed by BMC whereas any reduction in the rate of GST shall be passed on to BMC as per the provisions of the GST Act.

6. Contract Labour (Regulation and Abolition) Act, 1970: (As per Circular CLO/4 dated 03.06.2004)

The provisions of this act are applicable to the establishment or contractor of principle employer if they employ 50 or more contract labour or as per recent government circular in this regard. The principal employer is required to take Certificate of Registration and the Contractor is required to take a License from the designated Officer as per the act. The Act provides for certain welfare measures to be provided by law to contract labours by the contractor of Principal Employers.

7. The bidders shall take cognizance of circular u/no. Dy.Ch.E./CPD/2025 dated. 01.09.2021. As per the circular the clause of 'Grievance Redressal Mechanism' will be applicable for subject tender as annexed in Annexure 'O'.

8. The G.C.C. of SBD document has been incorporated in the tender. In case of dispute which could not be covered with the clauses of G.C.C. in SBD, however, covered in the clauses of Standard General Condition of Contract uploaded on website of BMC, the clauses of Standard G.C.C. will govern. Eventually, the decision of BMC will be binding on the contractor.

**SECTION 7**  
**SCOPE OF WORK**

## SCOPE OF WORK

The instant work is proposed for treatment of sewage water at MaladWWTF by Bioremediation technology to achieve the sewage effluent discharge parameters as specified by hon'ble NGT. The average flow of MaladWWTF is around 200 MLD. The brief scope of work includes following -

1. Determination of baseline values of inlet sewage parameter.
2. Treatment of sewage with Bioremediation Technology to achieve desired values of outflow sewage parameters after treatment.
3. Supply of microbial product / bio-culture, allied material, dosing system and deployment of required manpower, etc.
4. Provision of Electromechanical infrastructure required for the dosing of microbial / bio-culture.
5. Periodic testing of the sewage samples before and after treatment from the institutions like IIT, VJTI, NEERI or NABL accredited Labs as approved by BMC.
6. State-of-the-art online monitoring system at the outlet of the WWTF.

**The desired effluent parameters after treatment shall be as follows.**

Sr. No.	Parameter	Desired Value (As per Hon'ble NGT Norms)
1	BOD <sub>3 27</sub> (mg/l)	Shall not exceed 10 mg/l
2	TSS (mg/l)	Shall not exceed 20 mg/l
3	COD (mg/l)	Shall not exceed 50 mg/l
4	pH	6.5 to 9

**SECTION 8**  
**BILL OF QUANTITIES**

## BRIHANMUMBAI MUNICIPAL CORPORATION

**Subject** - Rehabilitation of Malad WWTF - Treatment of Sewage Water by  
Bioremediation Technology.

### BILL OF QUANTITIES

Sr.No.	Description of Item	Qty	Unit	Rate in Rs.	GST 18%	Amount in Rs
1	Rehabilitation of Malad WWTF - Treatment of Sewage Water by Bioremediation Technology - For 2 years	148000	MIL (Million Litre)	<i>to be filled online only</i>	<i>to be filled online only</i>	<i>to be filled online only</i>
		<b>Total Including GST in RS.</b>				
<b>(Note: To be Submitted Online in Cover Type 'Financial')</b>						

**SECTION 9**  
**GENERAL CONDITIONS OF CONTRACT**

# General Conditions of Contract

## A. General

### 1. Definitions

**1.1.** Terms which are defined in the Contract Data are not also defined in the Conditions of Contract but keep their defined meanings. Capital initials are used to identify defined terms.

**The “Contract”** shall mean the tender and acceptance thereof and the formal agreement if any, executed between the Contractor, Commissioner and the Corporation together with the documents referred to therein including these conditions and appendices and any special conditions, the specifications, designs, drawings, price schedules, bills of quantities and schedule of rates. All these documents taken together shall be deemed to form one Contract and shall be complementary to one another.

**The Contract Data** defines the documents and other information which comprise the Contract.

**The “Contractor”** shall mean the individual or firm or company whether incorporated or not, whose tender has been accepted by the employer and the legal successor of the individual or firm or company, but not (except with the consent of the Employer) any assignee of such person.

**The Bidder** is a person or corporate body who has desired to submit Bid to carry out the Works, including routine maintenance till the tender process is concluded.

**The Contractor's Bid** is the completed bidding document submitted by the Contractor to the Employer.

**The “Contract Sum”** means the sum named in the letter of acceptance including Physical contingencies subject to such addition thereto or deduction there-from as may be made under the provisions hereinafter contained.

**Note :** The contract sum shall include the following -



- In the case of percentage rate contracts the estimated value of works as mentioned in the tender adjusted by the Contractor's percentage.
- In the case of item rate contracts, the cost of the work arrived at after finalisation of the quantities shown in schedule of items / quantities by the item rates quoted by the tenderers for various items and summation of the extended cost of each item.
- In case of lump sum contract, the sum for which tender is accepted.
- Special discount / rebate / trade discount offered by the tenderer if any and accepted by the Corporation.
- Additions or deletions that are accepted after opening of the tenders.

**The "Contract Cost"** means the Contract Sum plus Price Variation. This cost shall be included in the letter of acceptance.

**A Defect** is any part of the Works not completed in accordance with the Contract.

**The Defects Liability Certificate** is the certificate issued by the Engineer, after the Defect Liability Period has ended and upon correction of Defects by the Contractor.

Drawings means all the drawings, calculations and technical information of a like nature provided by the Engineer to the Contractor under the Contract and all drawings, calculations, samples, patterns, models, operation & maintenance manual and other technical information of like nature submitted by the Contractor and approved by the Engineer.

**The Authority** shall mean Brihanmumbai Municipal Corporation(BMC)

**The "Employer"** shall mean the Municipal Corporation for Greater Mumbai / Municipal Commissioner for Greater Mumbai, for the time being holding the said office and also his successors and shall also include all "Additional Municipal Commissioners, Director (Engineering Services & Projects)" and the Deputy Municipal Commissioner, to whom the powers of Municipal Commissioner, have been deputed under Section 56 and 56B of the Mumbai Municipal Corporation Act.

**The Engineer in-charge** shall mean the Executive Engineer in executive charge of the works and shall include the superior officers of the Engineering department i.e. Dy.Ch.Eng / Ch.Eng. and shall mean and include all the successors in Brihanmumbai Municipal Corporation

**The Engineer's Representative** shall mean the Assistant Engineer, Sub. Engineer/Jr. Engineer in direct charge of the works and shall include Sub Eng./ Jr. Eng of Civil section/ Mechanical section/ Electrical section appointed by Brihanmumbai Municipal Corporation.

**The "Engineer"** shall mean the City Engineer / the Hydraulic Engineer / the Chief Engineer / the Special Engineer, appointed for the time being or any other officer or officers of the Municipal Corporation who may be authorized by the commissioner to carry out the functions of the City Engineer / the Hydraulic Engineer / the Chief Engineer / the Special Engineer or any other competent person appointed by the employer and notified in writing to the Contractor to act in replacement of the Engineer from time to time.

**Contractor's Equipment** means all appliances and things of whatsoever nature required for the execution and completions of the Works and the remedying of any defects therein, but do not include plant material or other things intended to form or forming part of the Permanent Works.

**The Initial Contract Price** is the Contract Price listed in the Employer's Letter of Acceptance.

**The Intended Completion Date** is the date on which it is intended that the Contractor shall complete the construction works. The Intended Completion Date is specified in the Contract Data. The Intended Completion Date may be revised only by the Engineer by issuing an extension of time.

**Materials** are all supplies, including consumables, used by the Contractor for incorporation in the Works and works of routine maintenance.

**Plant** is any integral part of the Works that shall have a mechanical, electrical, electronic, chemical, or biological function.

**Routine Maintenance** is the maintenance of activities of the completed structure for five years as specified in the Contract Data.

**The “Site”** shall mean the land and other places including water bodies more specifically mentioned in the special conditions of the tender, on, under in or through which the permanent works or temporary works are to be executed and any other lands and places provided by the Municipal Corporation for working space or any other purpose as may be specifically designated in the contract as forming part of the site.

**Site Investigation Reports** are those that were included in the bidding documents and are reports about the surface and subsurface conditions at the Site.

**“Specification”** shall mean the specification referred to in the tender and any modification thereof or addition or deduction thereto as may from time to time be furnished or approved in writing by the Engineer.

**The Start Date/Commencement Date** is given in the Contract Data. It is the date when the Contractor shall commence execution of the Works. It does not necessarily coincide with any of the Site Possession Dates.

**A Nominated Sub-Contractor** is a person or corporate body who has a Contract with the Contractor to carry out a part of the construction work and/or routine maintenance in the Contract, which includes work on the Site.

**Temporary Works** are works designed, constructed, installed, and removed by the Contractor that are needed for construction or installation of the Works.

**Variation** means a change to the:-

- i) Specification and /or Drawings (if any) which is instructed by the Employer.
- ii) Scope in the Contract which is instructed by the Employer.
- iii) Price in the Contract which is instructed by the Employer.

**The Works**, as defined in the Contract Data, are what the Contract requires the Contractor to construct, install, maintain, and turn over to the Employer. Routine maintenance is defined separately.

**Jurisdiction:** In case of any claim, dispute or difference arising in respect of a contract, the cause of action thereof shall be deemed to have arisen in Mumbai and all legal proceedings in respect of any claim, dispute or difference shall be instituted in a competent court in the City of Mumbai only.

## **2. Interpretation**

**2.1.** In interpreting these Conditions of Contract, singular also means plural, male also means female or neuter, and the other way around. Headings have no significance. Words have their normal meaning under the language of the Contract unless specifically defined. The Engineer will provide instructions clarifying queries about these Conditions of Contract.

**2.2.** If sectional completion is specified in the Contract Data, references in the Conditions of Contract to the Works, the Completion Date, and the Intended Completion Date apply to any Section of the Works (other than references to the Completion Date and Intended Completion Date for the whole of the Works).

**2.3.** The documents forming the Contract shall be interpreted in the following documents: (1) Agreement, (2) Letter of Acceptance, (3) Notice to Proceed with the Work, (4) Contractor's Bid, (5) Contract Data, (6) Special Conditions of Contract Part (7) General Conditions of Contract Part I, (8) Specifications, (9) Drawings, (10) Bill of Quantities, and (11) Any other document listed in the Contract Data.

## **3. Engineer's Decisions**

**3.1.** Except where otherwise specifically stated, the Engineer will decide contractual matters between the Employer and the Contractor in the role representing the Employer. However, if the Engineer is required under the rules and regulations and orders of the Employer to obtain prior approval of some other authorities for specific actions, he will so obtain the approval, before communicating his decision to the Contractor.

**3.2.** Except as expressly stated in the Contract, the Engineer shall not have any authority to relieve the Contractor of any of his obligations under the contract.

#### **4. Delegation**

The Engineer, with the approval of the Employer, may delegate any of his duties and responsibilities to other person(s), except to the Adjudicator, after notifying the Contractor, and may cancel any delegation after notifying the Contractor.

#### **5. Communications**

All certificates, notices or instructions to be given to the Contractor by Employer/ Engineer

shall be sent on the address or contact details given by the Contractor of Bid. The address and contact details for communication with the Employer/ Engineer shall be as per the details given in Contract Data. Communications between parties that are referred to in the conditions shall be in writing. The Notice sent by facsimile (fax) or other electronic means shall be effective on confirmation of the transmission. The Notice sent by Registered post or Speed post shall be effective on delivery or at the expiry of the normal delivery period as undertaken by the postal service.

#### **6. Subcontracting**

**6.1.** Unless specifically mentioned in the contract subletting will not be allowed. Subletting, where otherwise provided by the contract shall not be more than 25% of the contract price.

**6.2.** The Contractor shall not be required to obtain any consent from the Employer for:

- a. the sub-contracting of any part of the Works for which the Subcontractor is named in the Contract;
- b. the provision for labour, or labour component.
- c. the purchase of Materials which are in accordance with the standards specified in the Contract.

**6.3.** Beyond what has been stated in clauses 6.1 and 6.2, if the Contractor proposes sub contracting any part of the work during execution of the Works, because of some unforeseen circumstances to enable him to complete the Works as per terms of the Contract, the Employer will consider the following before according approval:

- a. The Contractor shall not sub-contract the whole of the Works.
- b. The permitted subletting of work by the Contractor shall not establish any contractual relationship between the sub-contractor and the Brihanmumbai Municipal Corporation and shall not relieve the Contractor of any responsibility under the Contract.

**6.4.** The Engineer should satisfy himself before recommending to the Employer whether,

- a. the circumstances warrant such sub-contracting; and
- b. the sub-Contractor so proposed for the Work possesses the experience, qualifications and equipment necessary for the job proposed to be entrusted to him.

## **7. Other Contractors**

**7.1.** The Contractor shall cooperate and share the Site with other Contractors, public authorities, utilities, and the Employer between the dates given in the Schedule of Other Contractors, as referred to in the Contract Data. The Contractor shall also provide facilities and services for them as described in the Schedule. The Employer may modify the Schedule of Other Contractors, and shall notify the Contractor of any such modification.

**7.2.** The Contractor should take up the works in convenient reaches as decided by the Engineer to ensure there is least hindrance to the smooth flow and safety of traffic including movement of vehicles and equipment of other Contractors till the completion of the Works.

## **8. Personnel**

**8.1.** The Contractor shall employ for the construction work and routine maintenance the key personnel including technical personnel named in the Contract Data or other personnel approved by the Engineer. The Engineer will approve any proposed replacement of technical personnel only if their relevant qualifications and abilities are substantially equal to those of the personnel stated in the Contract Data.

**8.2.** The Contractor's personnel shall appropriately be qualified, skilled and experienced in their respective trades or occupations. The Engineer shall have authority to remove, or cause to be removed, any person employed on the site or works, who carries out duties incompetently or negligently and persists in any conduct which is prejudicial to safety, health or the protection of the environment.

**8.3.** If the Engineer asks the Contractor to remove a person who is a member of the Contractor's staff or work force, stating the reasons, the Contractor shall ensure that the person leaves the Site within seven days and has no further connection with the Works in the Contract.

**8.4.** The Contractor shall not employ any retired Gazetted officer who has worked in the Engineering Department of the Brihanmumbai Municipal Corporation /State Government and has either not completed two years after the date of retirement or has not obtained Brihanmumbai Municipal Corporation /State Government's permission to employment with the Contractor.

## **9. Employer's and Contractor's Risks**

**9.1.** The Employer carries the risks which this Contract states are Employer's risks, and the Contractor carries the risks which this Contract states are Contractor's risks.

## **10. Employer's Risks**

**10.1.** The Employer is responsible for the excepted risks which are (a) in so far as they directly affect the execution of the Works in the Employer's country, the risks of war, invasion, act of foreign enemies, rebellion, revolution, insurrection or military or

usurped power, civil war, riot, commotion or disorder (unless restricted to the Contractor's employees) and contamination from any nuclear fuel or nuclear waste or radioactive toxic explosive, or (b) a cause due solely to the design of the Works, other than the Contractor's design.

## **11. Contractor's Risks**

**11.1.** All risks of loss of or damage to physical property and of personal injury and death which arise during and in consequence of the performance of the Contract other than the excepted risks, referred to in clause 10.1, are the responsibility of the Contractor.

## **12. Insurance**

**12.1.** The Contractor at his cost shall provide, in the joint names of the Employer and the Contractor, insurance cover from the Start Date to the end of Defects Liability Period, in the amounts and deductibles stated in the Contract Data for the following events which are due to the Contractor's risks:

- a) Loss of or damage to the Works, Plant and Materials;
- b) Loss of or damage to Equipment;
- c) Loss of or damage to property (other than the Works, Plant, Materials, and Equipment) in connection with the Contract; and
- d) Personal injury or death.

**12.2.** Insurance policies and certificates for insurance shall be delivered by the Contractor to the Engineer for the Engineer's approval on or before 30 days from the date of acceptance of LOA or actual start date of work at site, whichever is earlier. All such insurance shall provide for compensation to be payable in the types and proportions of currencies required to rectify the loss or damage incurred.

**12.3.** Alterations to the terms of insurance shall not be made without the approval of the Engineer.

**12.4.** Both parties shall comply with any conditions of the insurance policies.



**12.5.** If the Contractor does not provide any of the policies and certificates required, the Employer may affect the insurance which the Contractor should have provided and recover the premiums the Employer has paid, from payments otherwise due to the Contractor or if no payment is due, the payment of premiums shall be debt due.

### **13. Site Investigation Reports**

**13.1.** The Contractor, in preparing the Bid, may rely, at his own risk, on any Site Investigation Reports referred to in the Contract Data, supplemented by any other information available to him, before submitting the bid.

### **14. Queries about the Contract Data**

**14.1.** The Engineer will clarify queries on the Contract Data.

### **15. Contractor to Construct the Works and Undertake Maintenance (if specified in the tender)**

**15.1.** The Contractor shall construct, and install and maintain the Works in accordance with the Specifications and Drawings and as per instructions of the Engineer.

**15.2.** The Contractor shall construct the works with intermediate technology, i.e., by manual means with medium input of machinery required to ensure the quality of works as per specifications. The Contractor shall deploy the equipment and machinery as required in the contract.

**15.3.** The Contractor shall take all reasonable steps to protect the environment on and off the Site and to avoid damage or nuisance to persons or to property of the public or others resulting from pollution, noise or other causes arising as a consequence of his methods of operation.

During continuance of the contract, the Contractor and his sub-contractors shall abide at all times by all existing enactments on environmental protection and rules made there under, regulations, notifications and byelaws of the State or Central Government, or local authorities and any other law, bye-law, regulations that may be passed or notification that may be issued in future by the State or Central

Government or the local authority. Salient features of some of the major laws that are applicable are given below:

- The Water (Prevention and Control of Pollution) Act, 1974, this provides for the prevention and control of water pollution and the maintaining and restoring of wholesomeness of water. 'Pollution' means such contamination of water or such alteration of the physical, chemical or biological properties of water or such discharge of any sewage or trade effluent or of any other liquid, gaseous or solid substance into water (whether directly or indirectly) as may, or is likely to, create a nuisance or render such water harmful or injurious to public health or safety, or to domestic, commercial, industrial, agricultural or other legitimate uses, or to the life and health of animals or plants or of aquatic organisms.
- The Air (Prevention and Control of Pollution) Act, 1981, this provides for prevention, control and abatement of air pollution. 'Air Pollution' means the presence in the atmosphere of any 'air pollutant', which means any solid, liquid or gaseous substance (including noise) present in the atmosphere in such concentration as may be or tend to be injurious to human beings or other living creatures or plants or property or environment.
- The Environment (Protection) Act, 1986, this provides for the protection and improvement of environment and for matters connected therewith, and the prevention of hazards to human beings, other living creatures, plants and property. 'Environment' includes water, air and land and the interrelationship which exists among and between water, air and land, and human beings, other living creatures, plants, micro-organism and property.
- The Public Liability Insurance Act, 1991, This provides for public liability insurance for the purpose of providing immediate relief to the persons affected by accident occurring while handling hazardous substances and for matters connected herewith or incidental thereto. Hazardous substance means any substance or preparation which is defined as hazardous substance under the Environment (Protection) Act

1986, and exceeding such quantity as may be specified by notification by the Central Government.

**16. The Works and Routine Maintenance to be completed by the Intended Completion Date**

**16.1.** The Contractor may commence execution of the Works on the Start Date and shall carry out the Works and Routine Maintenance, if specified in the tender, in accordance with the Programme submitted by the Contractor, as updated with the approval of the Engineer, and complete them by the Intended Completion Date.

**17. Approval by the Engineer**

**17.1.** The Contractor shall submit Specifications and Drawings showing the proposed Temporary Works to the Engineer, who is to approve them if they comply with the Specifications and Drawings.

**17.2.** The Contractor shall be responsible for design and safety of Temporary Works.

**17.3.** The Engineer's approval shall not alter the Contractor's responsibility for design and safety of the Temporary Works.

**17.4.** The Contractor shall obtain approval of third parties to the design of the Temporary Works, where required.

**17.5.** All Drawings prepared by the Contractor for the execution of the temporary or permanent Works, are subject to prior approval by the Engineer before their use.

**18. Safety**

**18.1.** The Contractor shall be responsible for the safety of all activities on the Site. He shall comply with all applicable safety requirements and take care of safety of all persons entitled to be on the site and the works. He shall use reasonable efforts to keep the site and the works, both during construction and maintenance, clear of unnecessary obstruction so as to avoid danger to the persons and the users.

- Workers employed on mixing asphaltic materials, cement and lime mortars shall be provided with protective footwear and protective goggles.
- Stone breaker shall be provided with protective goggles and protective clothing and seated at sufficiently safe intervals.
- The area should be barricaded or cordoned off by suitable means to avoid mishaps of any kind. Power warning signs should be displayed for the safety of the public whenever cleaning works are undertaken during night or day.
- The workers engaged for cleaning the manholes/sewers should be properly trained before allowing working in the manhole.

**18.2. Safety Programs:-**

- I. Have adequate safety supervision in place to ensure that safety programs set up by the firms/agencies are in compliance with prevalent laws and regulations.
- II. Review safety programs developed by each of the trade firms, prepare and submit a comprehensive safety program.
- III. Monitor day to day implementation of safety procedures.

**18.3. First Aid Facilities: -**

- i. At every work place there shall be provided and maintained, so as to be easily accessible during working hours, first-aid boxes at the rate of not less than one box for 150 contract labour or part thereof ordinarily employed.
- ii. The first-aid box shall be distinctly marked with a red cross on white back ground.
- iii. Adequate arrangements shall be made for immediate recoument of the equipment when necessary.
- iv. Nothing except the prescribed contents shall be kept in the First-aid box.

- v. The first-aid box shall be kept in charge of a responsible person who shall always be readily available during the working hours of the work place.
- vi. A person in charge of the First-aid box shall be a person trained in First-aid treatment, in the work places where the number of contract labour employed is 150 or more.

## **19. Discoveries**

**19.1.** Anything of historical or other interest or of significant value unexpectedly discovered on the Site shall be the property of the Employer. The Contractor shall notify the Engineer of such discoveries and carry out the Engineer's instructions for dealing with them.

## **20. Possession of the Site**

**20.1.** The Employer shall handover complete or part possession of the site to the Contractor 7 days in advance of construction programme. At the start of the work, the Employer shall handover the possession of at-least 75% of the site free of all encumbrances, the remaining 25 % of the possession as per contractor's construction programme.

## **21. Access to the Site**

**21.1.** The Contractor shall allow access to the Site and to any place where work in connection with the Contract is being carried out, or is intended to be carried out to the Engineer and any person/persons/agency authorized by: a. The Engineer b. The Employer or authorized by the Employer.

## **22. Instructions**

**22.1.** The Contractor shall carry out all instructions of the Engineer, which comply with the applicable laws where the Site is located.

**22.2.** The Contractor shall permit the appointed and/or authorized persons to inspect the Site and/or accounts and records of the Contractor and its subcontractors relating

to the performance of the Contract, and to have such accounts and records audited by auditors appointed, if so required. The Contractor's attention is invited to Clause of 'Fraud and Corruption', which provides, inter alia, that acts intended to materially impede the exercise of the inspection and audit rights provided for under the Clause & constitute a obstructive practice subject to contract termination

**22.3. Engineer to have power to issue further drawings or instructions:**

The Engineer shall have the power and authority from time to time and at all times to make and issue such further drawings and to give such further instructions and directions as may appear to him necessary or proper for the guidance of the contractor and the good and sufficient execution of the works according to terms of the specifications and Contractor shall receive, execute, obey and be bound by the same, according to the true intent and meaning thereof, as fully and effectually as though the same had accompanied or had been mentioned or referred to in the specification, and the Engineer may also alter or vary the levels or position of nature of works contemplated by the specifications, or may order any of the works contemplated thereby to be omitted, with or without the substitution of any other works in lieu thereof, or may order any work or any portion of work executed or partially executed, to be removed, changed or altered, added if needful, may order that other works shall be substituted instead thereof and difference of expense occasioned by any such diminution or alteration so ordered and directed shall be added to or deducted from the amount of this Contract, as provided under condition no.10(a) hereinafter.

No work which radically changes the original nature of the Contract shall be ordered by the Engineer and in the event of any deviation being ordered which in the opinion of the Contractor changes the original nature of Contract he shall nevertheless carry it out and disagreement as to the nature of the work and the rate to be paid therefore shall be resolved in accordance with condition no. 73.

The time for completion of the Works, shall be in even of any deviations resulting in additional cost over the contract price being ordered, be extended or reduced reasonably by the Engineer. The Engineer's decision in this case shall be final.

## **B. Time Control**

### **23. Programme**

**23.1.** Within the time stated in the Contract Data, the Contractor shall submit to the Engineer for approval a Programme, including Environment Management Plan showing the general methods, arrangements, order, and timing for all the activities in the Works, along with monthly cash flow forecasts for the construction of works.

After the completion of the construction works, the programme for the Routine Maintenance Work, showing the general methods, arrangements, order and timing for all the activities involved in the Routine Maintenance will also be submitted by the Contractor to the Engineer for approval if specified in the tender. The programme for Routine Maintenance will be submitted in each year for the period of Maintenance.

**23.2.** The Contractor shall submit the list of equipment and machinery being brought to site, the list of key personnel being deployed, the list of machinery/ equipments being placed in field laboratory and the location of field laboratory along with the Programme. The Engineer shall cause these details to be verified at each appropriate stage of the programme.

**23.3.** An update of the Programme shall be a programme showing the actual progress achieved on each activity and the effect of the progress achieved on the timing of the remaining Works, including any changes to the sequence of the activities.

**23.4.** The Contractor shall submit to the Engineer for approval an updated Programme at intervals no longer than the period stated in the Contract Data. If the Contractor does not submit an updated Programme within this period, the Engineer may withhold the amount stated in the Contract Data from the next payment certificate and continue to withhold this amount until the next payment after the date on which the overdue Programme has been submitted.

**23.5.** The Engineer's approval of the Programme shall not alter the Contractor's obligations. The Contractor may revise the Programme and submit it to the Engineer

again at any time. A revised Programme shall show the effect of Variations and Compensation Events.

#### **24. Extension Of Time In Contracts :**

Subject to any requirement in the contract as to completion of any portions or portions of the works before completion of the whole, the contractor shall fully and finally complete the whole of the works comprised in the contract (with such modifications as may be directed under conditions of this contract) by the date entered in the contract or extended date in terms of the following clauses:

##### **a) Extension attributable to Brihanmumbai Municipal Corporation**

- i) **Extension Due To Modification:** If any modifications have been ordered which in the opinion of the Engineer have materially increased the magnitude of the work, then such extension of the contracted date of completion may be granted as shall appear to the Engineer to be reasonable in the circumstances, provided moreover that the Contractor shall be responsible for requesting such extension of the date as may be considered necessary as soon as the cause thereof shall arise and in any case **should not be less than 30 days before the expiry of the date fixed for completion of the works.**
- ii) **Extension For Delay Due To Brihanmumbai Municipal Corporation:** In the event of any failure or delay by the Brihanmumbai Municipal Corporation to hand over the Contractor possession of the lands necessary for the execution of the works or to give the necessary notice to commence the works or to provide the necessary drawings or instructions or any other delay caused by the Brihanmumbai Municipal Corporation due to any other cause whatsoever, then such failure or delay shall in no way affect or vitiate the contract or alter the character thereof or entitle the contractor to damages or compensation therefore, but in any such case, the Brihanmumbai Municipal Corporation may grant such extension(s) of the completion date as may be considered reasonable.



**Note: For extension of time period as governed in (i) and (ii) above, any modifications in design/drawings, specifications, quantities shall be needed to be justified with recorded reasons with approval of Ch.Eng. for not anticipating the same while preparing estimates and draft tender.**

**b) Extension Of Time For Delay Due To Contractor :**

The time for the execution of the work or part of the works specified in the contract documents shall be deemed to be the essence of the contract and the works must be completed no later than the date(s) / the programme for completion of work as specified in the contract. If the contractor fails to complete the works within the time as specified in the contract for the reasons other than the reasons specified in above as (a.i) and (a.ii), the Brihanmumbai Municipal Corporation may, if satisfied that the works can be completed by the contractor within reasonable short time thereafter, allow the contractor for further extension of time as the Engineer may decide. On such extension the Brihanmumbai Municipal Corporation will be entitled without prejudice to any other right and remedy available on that behalf, to recover the compensation as governed by Clause 8(e) of GCC.

For the purpose of this Clause, the contract value of the works shall be taken as value of work as per contract agreement including any supplementary work order/contract agreement issued.

Further, competent authority while granting extension to the currency of contract under Clause (b) of as above may also consider levy of penalty, as deemed fit based on the merit of the case. Also, the reasons for granting extension shall be properly documented.

**25. Delays Ordered by the Engineer**

**25.1.** The Engineer may instruct the Contractor to delay the start or progress of any activity within the Works. Delay/delays totalling more than 30 days will require prior written approval of the DMC/AMC.

## **26. Management Meetings**

**26.1.** The Engineer may require the Contractor to attend a management meeting. The business of a management meeting shall be to review the plans for progress of the Works.

**26.2.** The Engineer shall record the business of management meetings and provide copies of the record to those attending the meeting. The responsibility of the parties for actions to be taken shall be decided by the Engineer either at the management meeting or after the management meeting and stated in writing to all those who attended the meeting.

## **C. Quality Control**

### **27. Quality Control**

#### **27.1. Work to be open to Inspection and Contractor or Responsible agent to be present**

All works under or in course of execution or executed in pursuance of the contract shall at all times be open to the inspection and supervision of the Eng-in-charge and his subordinates and the contractor shall at all times during the usual working hours, at all other times, during the usual working hours and at all other times at which reasonable notice of the intention of the Eng-in-charge and his subordinates to visit the works shall have been given to the contractor, either himself be present to receive orders and instruction or have responsible agent duly accredited in writing present for that purpose. Order given to the contractors' duly authorized agent shall be considered to have the same force and effect as if they had been given to the contractor himself.

#### **27.2. Notice To Be Given Before Work Is Covered Up**

The contractor shall give (not less than ten days) notice in writing to the Eng-In-Charge or his subordinate in-charge of the work before covering up or otherwise placing beyond the reach of measurement any work in order that the same may be measured and correct dimension thereof taken before the same is so covered up or placed beyond the reach of measurements and shall not cover up or place beyond the reach of measurement any work without the consent in writing of the Eng-In-Charge or his subordinate in-charge of the work, and if any work shall be covered up or placed beyond the reach of measurement, without such notice having been given or consent obtained the same shall be uncovered at the contractors expenses, and in default thereof no payment or allowance shall be made for such work or for the materials with which the same was executed

#### **27.3. Works to be executed in accordance with specifications / drawings / orders etc. :**

The contractor shall execute the whole and every part of the work the most substantial and workman like manner and both has regards material and every other respect in strict accordance with specifications. The contractor shall also confirm exactly,

fully and faithfully to the designs, drawings and instructions in writing relating to the work signed by the Engineer In-charge and lodged in his office and to which the contractor shall be entitled to have access for the purpose of inspection at such office, or on the site or work during office hours. The contractor shall be entitled to receive three sets of contract drawings and working drawings as well as one certified copy of the accepted tender along with the work order free of cost.

#### **27.4. Ready Mix Concrete/ Asphalt Mix**

- i) The contractor shall have to arrange Ready Mix concrete (RMC)/Asphalt from RMC/ASPHALT producing plants registered with Brihanmumbai Municipal Corporation
- ii) The contractor shall, within a 7 days of award of the work, submit a list of at least three RMC/Asphalt producers with details of such plants including details and number of transit, mixers & pumps etc. to be deployed indicating name of owner/company, its location, capacity, technical establishment.

The Engineer-in-charge will reserve right to inspect at any stage and reject the concrete if he is not satisfied about quality of product at the user's end.

- iii) The Engineer-in-charge reserves the right to exercise control over the:-
  - a) Calibration check of the RMC/Asphalt plant.
  - b) Weight and quantity check on the ingredients, water and admixtures added for batch mixing for RMC plants
  - c) Time of mixing of concrete/grade of asphalt.
  - d) Testing of fresh concrete/asphalt mix, recording of results and declaring the mix fit or unfit for use. This will include continuous control on the work ability during production and taking corrective action, if required.
  - e) For exercising such control, the Engineer-in-charge shall periodically depute his authorized representative at the RMC/Asphalt plant. It shall be responsibility of the contractor to ensure that all necessary equipment,

manpower & facilities are made available to Engineer-in-charge and or his authorized representative at RMC/Asphalt plant.

- f) All required relevant records of RMC/Asphalt mix shall be made available to the Engineer-in-charge or his authorized representative. Engineer-in-charge shall, as required, specify guidelines & additional procedures for quality control & other parameters in respect of material production & transportation of concrete mix which shall be binding on the contractor & the RMC/Asphalt plant. Only concrete as approved in design mix by Engineer-in-charge shall be produced in RMC plant and transported to the site.
- g) The contractor shall have to produce a copy of chalan receipts/SCADA reports/VTS reports as issued by the RMC/Asphalt plant as a documentary proof in lieu of supply of RMC/Asphalt mix before releasing payment.

## **28. Identifying Defects**

**28.1.** The Engineer shall check the Contractor's work and notify the Contractor of any Defects that are found. Such checking shall not affect the Contractor's responsibilities. The Engineer may instruct the Contractor to search for a Defect and to uncover and test any work that the Engineer considers may have a Defect.

**28.2.** The Contractor shall permit the Employer's technical person(s) to check the Contractor's work and notify the Engineer and Contractor if any defects that are found.

## **29. Tests**

**29.1.** For carrying out mandatory tests as prescribed in the specifications, the Contractor shall establish field laboratory at the location decided by Engineer. The field laboratory will have minimum of equipments as specified in the Contract Data. The contractor shall be solely responsible for:

- a. Carrying out the mandatory tests prescribed in the Specifications, and
- b. For the correctness of the test results, whether performed in his laboratory or elsewhere.

**29.2.** If the Engineer instructs the Contractor to carry out a test not specified in the Specification/ Quality Assurance Handbook to check whether any work has a Defect and the test shows that it does, the Contractor shall pay for the test and any samples. If there is no defect, the test shall be a compensation event.

When required by the Engineer-in-charge the contractor(s) shall supply for the purpose of testing samples of all materials proposed to be used in the works. Samples submitted either to govern bulk supplies or required for testing before use shall be in suitable packages to contain them and shall be provided free of charge by the contractor. The cost of testing shall be borne by the contractor even if the result of the sample confirm or do not confirm to the relevant BIS code specifications.

- i. All expenditure required to be incurred for taking the samples conveyance, packing shall be borne by the contractor himself.
- ii. The failed material shall be removed from the site by the contractor at his own cost within a week time of written order of the Engineer-in-charge.

**29.3. Setting of Site Laboratories: (Not Applicable)**

Contractors shall set up a laboratory at site before commencement of work at their cost for performing various tests and at least the following machines and equipments shall be provided therein -

1. Set of Sieves as per I.R.C. /I.S.
2. Compressive Testing Machine(For new works)
3. Oven, Electrically Operated
4. Weighing Balance (20 kg capacity)
5. 3 m straight edge
6. Sieve shaker
7. First Aid Box
8. Measuring Jar (for silt content)
9. Other Machines/apparatus as may be directed by the Engineer
10. Vernier Caliber
11. Level / Theodolite

All the test records shall be maintained in the site office and made available as and when required. The laboratory must be established within 15 days from the date of receipt of the orders from Engineer In charge. On failure to do so, a penalty of Rs 1000/- per day shall be imposed.

The contractor shall install testing equipment at site. The contractor shall ensure and certify the calibration of the equipment so installed and shall maintain the same in working order throughout the period of construction. The contractor shall also provide necessary technically qualified experienced trained staff for carrying out such tests for using such equipment. The tests shall be carried out under the supervision of the Engineer-in-charge. The calibration shall be checked every twelve months as directed by Engineer-in-charge.

**30. Correction of Defects noticed during the Defects Liability Period.**

- a) The Engineer shall give notice to the Contractor of any Defects before the end of the Defects Liability Period, which begins at Completion and ends after five years. The Defects Liability Period shall be extended for as long as Defects remain to be corrected.
- b) Every time notice of Defect/Defects is given, the Contractor shall correct the notified Defect/Defects within the duration of time specified by the Engineer's notice.
- c) The Engineer may issue notice to the Contractor to carry out removal of defects or deficiencies, if any, noticed in his inspection, or brought to his notice. The Contractor shall remove the defects and deficiencies within the period specified in the notice and submit to the Engineer a compliance report.

**31. Uncorrected Defects and Deficiencies**

If the Contractor has not corrected a Defect pertaining to the Defect Liability Period under clause and deficiencies in maintenance, to the satisfaction of the Engineer, within the time specified in the Engineer's notice, the Engineer will assess the cost of having the Defect or deficiency corrected, and the Contractor shall pay this amount, on correction of the Defect or deficiency by another agency.

## **D. Cost Control**

### **32. Variations**

The Engineer shall, having regard to the scope of the Works and the sanctioned estimated cost, have power to order, in writing, Variations within the scope of the Works he considers necessary or advisable during the progress of the Works. Such Variations shall form part of the Contract and the Contractor shall carry them out and include them in updated Programmes produced by the Contractor. Oral orders of the Engineer for Variations, unless followed by written confirmation, shall not be taken into account.

### **33. Payments for Variations**

**33.1.** If rates for Variation items are specified in the Bill of Quantities, the Contractor shall carry out such work at the same rate.

**33.2.** The rate for Extra/Excess shall be governed by clause 10.A of Standard General Condition of Contract

### **34. Cash Flow Forecasts**

When the Programme is updated, the Contractor shall provide the Engineer with an updated cash flow forecast.

### **35. Payment Certificates**

The payment to the Contractor will be as follows for construction work:

- a) A bill shall be submitted by the Contractor monthly or before the date fixed by the Engineer In-charge for all works executed in the previous month, and the Engineer In-charge shall take or cause to be taken requisite measurement for the purpose of having the same verified and the claim, so far as it is admissible, shall be adjusted, if possible, within 10 days from the presentation of the bill. If the contractor does not submit the bill within the time fixed as aforesaid, the Engineer In-charge may depute a subordinate to measure up the said work in the presence of the contractor or his duly authorized agent whose counter signature to the measurement list shall be



sufficient warrant, and Engineer In-Charge may prepare a bill from such list which shall be binding on the contractor in all respects.

- b) The Engineer shall check the Contractor's fortnightly/monthly statement within 14 days and certify the amount to be paid to the Contractor.
- c) The value of work executed shall be determined, based on measurements by the Engineer.
- d) The value of work executed shall comprise the value of the quantities of the items in the Bill of Quantities completed.
- e) The value of work executed shall also include the valuation of Variations and Compensation Events.
- f) The Engineer may exclude any item certified in a previous certificate or reduce the proportion of any item previously certified in any certificate in the light of later information.
- g) The contractor shall submit all bills on the printed forms at the office of Engineer In-charge. The charges to be made in the bills shall always be entered at the rates specified in tender.

### **36. Payments**

**36.1.** Payments shall be adjusted for deductions for advance payments, retention, security deposit, other recoveries in terms of the Contract and taxes at source, as applicable under the law. The Employer shall pay the Contractor the amounts certified by the Engineer within 15 days of the date of each certificate.

**36.2.** All sums payable by a contractor by way of compensation under any of these conditions, shall be considered as a reasonable compensation to be applied to the use of Brihanmumbai Municipal Corporation without reference to the actual loss or damage sustained and whether any damage has or has not been sustained.

**36.3.** No payment shall be made for any work estimated to cost less than Rupees One Thousand till after the whole of work shall have been completed and the certificate of completion given. But in the case of works estimated to cost more than Rs. One Thousand, the contractor shall on submitting a monthly bill therefore be entitled to receive payment proportionate to the part of the work than approved and passed by the Engineer In-charge, whose certificate of such approval and passing of the sum so payable shall be final and conclusive against the contractor. All such intermediate payments shall be regarded as payments by way of advance against the final payments only and not as payments for work actual done and completed and shall not preclude the Engineer In-charge from requiring any bad, unsound, imperfect or unskillful work to be removed or taken away and reconstructed or re-erected nor shall any such payment be considered as an admission of the due performance of the contract or any part thereof in any respect or the offering of any claim not shall it conclude, determine or effect in any other way, the powers of the Engineer In-charge as to the final settlement and adjustment of the accounts or otherwise, or in any other way vary or effect the contract. The final bill shall be submitted by the Contractor within one month of the date fixed for the completion of the work otherwise the Engineer In-charge's certificate of the measurements and of the total amount payable for the work shall be final and binding on all parties.

**37.** The Contractor shall not be entitled to compensation to the extent that the Employer's interests are adversely affected by the Contractor for not having given early warning or not having cooperated with the Engineer.

**38. Tax**

GST and other state levies/cess which are not subsumed under GST will be applicable. The tenderer shall quote inclusive of all taxes applicable at the time of bid submission. It is clearly understood that BMC will not bear any additional liability towards payment of any Taxes & Duties.

Wherever the services to be provided by the Tenderers, falls under Reverse Charge Mechanism, the Price quoted shall be exclusive of GST, but inclusive of Taxes/Duties/Cess other than GST, if any.

Rates accepted by BMC shall hold good till completion of work shall be admissible on account of fluctuations in market rates; increase in taxes/any other levies / tolls etc. except that payment/recovery for overall market situation shall be made as per Price variation and if there is any subsequent change (after submission of bid) in rate of GST applicable on the work/services to be executed as per tender, i.e. any increase will be reimbursed by BMC whereas any reduction in the rate of GST shall be passed on to BMC as per the provisions of the GST Act.

### **39. Currencies**

All payments will be made in Indian Rupees.

### **40. Liquidated Damages**

Both, the Contractor and the Employer have agreed that it is not feasible to precisely estimate the amount of losses due to delay in completion of works and the losses to the public and the economy, therefore, both the parties have agreed that the Contractor shall pay liquidated damages to the Employer and not by way of penalty, at the rate per week or part thereof stated in the Contract Data for the period that the Completion Date is later than the Intended Completion Date. Liquidated damages at the same rates shall be withheld if the Contractor fails to achieve the milestones prescribed in the Contract Data. However, in case the Contractor achieves the next milestone, the amount of the liquidated damages already withheld shall be restored to the Contractor by adjustment in the next payment certificate. The Employer and the contractor have agreed that this is a reasonable agreed amount of liquidated damage. The Employer may deduct liquidated damages from payments due to the Contractor. Payment of liquidated damages shall not affect the Contractor's other liabilities.

### **41. Cost of Repairs**

Loss or damage to the Works or Materials to be incorporated in the Works between the Start Date and the end of the Defects Correction periods shall be remedied by the Contractor at his cost if the loss or damage arises from the Contractor's acts or omissions.

## **E. Finishing the Contract**

### **42. Completion of Construction and Maintenance**

**42.1.** The Contractor shall request the Engineer to issue a certificate of completion of the construction of the works, and the Engineer will do so upon deciding that the works is completed. This shall be governed as per clause no.8(g) of Standard General Conditions of Contract.

### **43. Taking Over**

**43.1.** The Employer shall take over the works within seven days of the Engineer issuing a certificate of completion of works. The Contractor shall continue to remain responsible for its routine maintenance during the maintenance period if specified in the contract.

### **44. Final Account**

Final joint measurement along with the representatives of the contractor should be taken recorded and signed by the Contractors. Contractors should submit the final bill within 1 month of physical completion of the work.

If the contractor fails to submit the final bill within 1 month, the Brihanmumbai Municipal Corporation staff will prepare the final bill based on the joint measurement within next 3 months.

Engineer's decision shall be final in respect of claims for defect and pending claims against contractors.

No further claims should be made by the Contractor after submission of the final bill and these shall be deemed to have been waived and extinguished. Payment of those items of the bills in respect of which there is no dispute and of items in dispute, for quantities and rates as approved by the Commissioner shall be made within a reasonable period as may be necessary for the purpose of verification etc.

After payment of the final bill as aforesaid has been made, the contractor may, if he so desires, reconsider his position in respect of a disputed portion of the final bills and if he fails to do so within 84 days, his disputed claim shall be dealt with as provided in the contract.

A percentage of the retention money, over and above the actual retention money as indicated below shall be held back from payments till the finalization of final bill to be submitted as per above and will be paid within 30 days of acceptance of the final bill.

Sr.no.	Amount of Contract Cost	Minimum Payable Amount in final bill
1	Up to Rs.5 Crs.	Rs.10 Lacs or final bill whichever is more
2	Up to Rs.25 Crs.	Rs.1 Crore or final bill amount whichever is more
3	Up to Rs. 50 Crs.	Rs.2 Crores or final bill amount whichever is more
4	Up to Rs.100 Crs.	Rs.4 Crore or final bill amount whichever is more
5	More than Rs.100 Crs.	Rs.7 Crore or final bill amount whichever is more

The contractor has to submit the bill for the work carried out within 15 days from the date of completion of the work to the respective executing department. If the contractor fails to submit their bills to concerned executing department, penalty or action as shown below will be taken for each delayed bill:-

After 15 days from the date of completion/running bill up to certain date, up to next 15 days i.e. up to 30 days	Equal to 5% of bill amount
Next 15 days up to 45 days from the date of completion/running bill up to specified date	Equal to 10% of bill amount
If not submitted within 45 days from the date of completion/ R.A. bill	Bill will not be admitted for payment.

#### **45. Operating and Maintenance Manuals**

**45.1.** If "as built" Drawings and/or operating and maintenance manuals are required, the Contractor shall supply them by the dates stated in the Contract Data.

**45.2.** If the Contractor does not supply the Drawings and/or manuals by the dates stated in the Contract Data, or they do not receive the Engineer's approval, the Engineer shall withhold the amount stated in the Contract Data from payments due to the Contractor.

#### **46. Termination**

**46.1.** The Employer or the Contractor may terminate the Contract if the other party causes a fundamental breach of the Contract.

**46.2.** Fundamental breaches of Contract shall include, but shall not be limited to, the following:

- a) the Contractor stops work for 30 days when no stoppage of work is shown on the current Programme and the stoppage has not been authorized by the Engineer;
- b) the Contractor is declared as bankrupt or goes into liquidation other than for approved reconstruction or amalgamation;
- c) the Engineer gives Notice that failure to correct a particular Defect is a fundamental breach of Contract and the Contractor fails to correct it within a reasonable period of time determined by the Engineer;
- d) the Contractor does not maintain a Security, which is required;
- e) the Contractor has delayed the completion of the Works by the number of days for which the maximum amount of liquidated damages can be paid, as defined in relevant clause.
- f) the Contractor fails to provide insurance cover as required under relevant clause .
- g) if the Contractor, in the judgment of the Employer, has engaged in the corrupt or fraudulent practices as defined in GCC in competing for or in executing the Contract.
- h) if the Contractor fails to set up a field laboratory with the prescribed equipment, within the period specified in the Contract Data; and

- i) any other fundamental breaches as specified in the Contract Data.
- j) if the Contractor fails to deploy machinery and equipment or personnel as specified in the Contract Data at the appropriate time.

**46.3.** When either party to the contract gives notice of a breach of contract to the Engineer for a cause other than those listed above, the Engineer shall decide whether the breach is fundamental or not.

**46.4.** Notwithstanding the above, the Employer may terminate the Contract for convenience.

**46.5.** If the Contract is terminated, the Contractor shall stop work immediately, make the Site safe and secure, and leave the Site as soon as reasonably possible.

#### **47. Payment upon Termination**

**47.1.** If the Contract is terminated because of a fundamental breach of Contract by the Contractor, the Engineer shall issue a certificate for value of the work done and materials ordered less liquidated damages, if any, less advance payments received up to the date of the issue of the certificate and less the percentage to apply to the value of the work not completed, as indicated in the Contract Data. If the total amount due to the Employer exceeds any payment due to the Contractor, the difference shall be recovered from the security deposit, and performance security. If any amount is still left unrecovered it will be a debt due from the Contractor to the Employer

**47.2.** If the Contract is terminated at the Employer's convenience, the Engineer shall issue a certificate for the value of the work done, the reasonable cost of removal of Equipment, repatriation of the Contractor's personnel employed solely on the Works, and the Contractor's costs of protecting and securing the Works and less advance payments received up to the date of the certificate, less other recoveries due in terms of the Contract, and less taxes due to be deducted at source as per applicable law.

## **48. Property**

**48.1.** All Materials on the Site, Plant, Equipment, Temporary Works, and Works shall be deemed to be the property of the Employer for use for completing balance construction work if the Contract is terminated because of the Contractor's default, till the Works is completed after which it will be transferred to the Contractor and credit, if any, given for its use.

## **49. Release from Performance**

If the Contract is frustrated by the outbreak of war or by any other event entirely outside the control of the Employer or the Contractor, the Engineer shall certify that the Contract has been frustrated. The Contractor shall make the Site safe and stop work as quickly as possible after receiving this certificate and shall be paid for all work carried out before receiving it and for any work carried out afterwards to which a commitment was made.

### **A)Other Conditions of Contract**

## **50. Labour**

**50.1.** The Contractor shall, unless otherwise provided in the Contract, make his own arrangements for the engagement of all staff and labour, local or other, and for their payment, housing, feeding and transport.

**50.2.** The Contractor shall, if required by the Engineer, deliver to the Engineer a return in detail, in such form and at such intervals as the Engineer may prescribe, showing the staff and the number of the several classes of labour from time to time employed by the Contractor on the Site and such other information as the Engineer may require.

## **51. Compliance with Labour Regulations**

- a) During continuance of the Contract, the Contractor and his sub-Contractors shall abide at all times by all existing labour enactments and rules made there under, regulations, notifications and bye laws of the State or Central Government or local authority and any other labour law (including rules), regulations, bye laws that may



be passed or notification that may be issued under any labour law in future either by the State or the Central Government or the local authority.

- b) Furthermore, the Contractor shall keep the Employer indemnified in case any action is taken against the Employer by the competent authority on account of contravention of any of the provisions of any Act or rules made there under, regulations or notifications including amendments. If the Employer is caused to pay or reimburse, such amounts as may be necessary to cause or observe, or for non-observance of the provisions stipulated in the notifications/bye laws/Acts/Rules/regulations including amendments, if any, on the part of the Contractor, the Engineer/Employer shall have the right to deduct any money due to the Contractor including his amount of performance guarantee. The Employer/Engineer shall also have right to recover from the Contractor any sum required or estimated to be required for making good the loss or damage suffered by the Employer.
- c) The Contractor shall require his employees to obey all applicable laws, including those concerning safety at work.
- d) The employees of the Contractor and the Sub-Contractor in no case shall be treated as the employees of the Employer at any point of time.

## **52. Drawings and Photographs of the Works**

**52.1.** The Contractor shall do photography/video photography of the site firstly before the start of the work, secondly mid-way in the execution of different stages of work as required by Engineer In-charge and lastly after the completion of the work. No separate payment will be made to the Contractor for this.

**52.2.** The Contractor shall not disclose details of Drawings furnished to him and works on which he is engaged without the prior approval of the Engineer in writing. No photograph of the works or any part thereof or plant employed thereon, except those permitted under above clause, shall be taken or permitted by the Contractor to be taken by any of his employees or any employees of his sub-Contractors without the

prior approval of the Engineer in writing. No photographs/ Video photography shall be published or otherwise circulated without the approval of the Engineer in writing.

### **53. The Apprentices Act, 1961**

The Contractor shall duly comply with the provisions of the Apprentices Act 1961 (III of 1961), the rules made there under and the orders that may be issued from time to time under the said Act and the said Rules and on his failure or neglect to do so, he shall be subject to all liabilities and penalties provided by the said Act and said Rules.

### **54. Contract Document**

The documents forming the contract are to be taken as mutually explanatory of one another.

Unless otherwise provided in the contract, the priority of the documents forming the contract shall be, as follows:

1. Contract Agreement (if completed)
2. The letter of Acceptance
3. The Bid:
4. Addendum to Bid; if any
5. Tender Document
6. The Bill of Quantities:
7. The Specification:
8. Detailed Engineering Drawings
9. Standard General Conditions of Contracts (GCC)
10. All correspondence documents between bidder/contractor and Brihanmumbai Municipal Corporation.

### **55. Conflict of Interest**

The Applicant shall not have a conflict of interest (the "Conflict of Interest") that affects the Bidding Process. Any Applicant found to have a Conflict of Interest shall be disqualified. An Applicant shall be deemed to have a Conflict of Interest affecting the Bidding Process, if

1. A constituent of such Applicant is also a constituent of another Applicant; or
2. Such Applicant has the same legal representative for purposes of this Application as any other Applicant; or
3. Such Applicant, or any Associate thereof has a relationship with another Applicant, or any Associate thereof, directly or through common third party/ parties, that puts either or both of them in a position to have access to each other's information about, or to influence the Application of either or each other; or
4. The Applicant shall be liable for disqualification if any legal, financial or technical adviser of the Authority in relation to the Project is engaged by the Applicant, its Member or any Associate thereof, as the case may be, in any manner for matters related to or incidental to the Project. For the avoidance of doubt, this disqualification shall not apply where such adviser was engaged by the Applicant, its Member or Associate in the past but its assignment expired or was terminated 6 (six) months prior to the date of issue of this TENDER. Nor will this disqualification apply where such adviser is engaged after a period of 3 (three) years from the date of commercial operation of the Project.

**56. Applications and costs thereof**

No Applicant shall submit more than one Application for the Project. An applicant applying individually shall not be entitled to submit another application either individually. The Applicant shall be responsible for all of the costs associated with the preparation of their Applications and their participation in the Bid Process. The Authority will not be responsible or in any way liable for such costs, regardless of the conduct or outcome of the Bidding Process.

**57. Acknowledgment by Applicant**

It shall be deemed that by submitting the Application, the Applicant has:

- a. made a complete and careful examination of the tender;
- b. received all relevant information requested from the Authority;
- c. accepted the risk of inadequacy, error or mistake in the information provided in the tender or furnished by or on behalf of the Authority relating to any of the matters referred; and
- d. Agreed to be bound by the undertakings provided by it under and in terms hereof.

“The Authority” shall not be liable for any omission, mistake or error in respect of any of the above or on account of any matter or thing arising out of or concerning or relating to the TENDER or the Bidding Process, including any error or mistake therein or in any information or data given by the Authority.

**58. Right to accept or reject any or all Applications/ Bids**

Notwithstanding anything contained in this TENDER, “The Authority” reserves the right to accept or reject any Application and to annul the Bidding Process and reject all Applications/ Bids, at any time without any liability or any obligation for such acceptance, rejection or annulment, and without assigning any reasons therefore. In the event that the Authority rejects or annuls all the Bids, it may, in its discretion, invite all eligible Bidders to submit fresh Bids hereunder.

“The Authority” reserves the right to reject any Application and/ or Bid if:

- a) at any time, a material misrepresentation is made or uncovered, or
- b) the Applicant does not provide, within the time specified by the Authority, the supplemental information sought by the Authority for evaluation of the Application.

In case it is found during the evaluation or at any time before signing of the Agreement or after its execution and during the period of subsistence thereof including the concession thereby granted by “The Authority”, that one or more of the pre-qualification conditions have not been met by the Applicant, or the Applicant has made material misrepresentation or has given any materially incorrect or false information, the

Applicant shall be disqualified forthwith if not yet appointed as the Successful Bidder either by issue of the LOA (Letter of Approval) or entering into of the Agreement, and if the Applicant has already been issued the LOA or has entered into the Concession Agreement, as the case may be, the same shall, notwithstanding anything to the contrary contained therein or in this TENDER, be liable to be terminated, by a communication in writing by "The Authority" to the Applicant, without the Authority being liable in any manner whatsoever to the Applicant and without prejudice to any other right or remedy which the Authority may have under this TENDER, the Bidding Documents, the Concession Agreement or under applicable law. "The Authority" reserves the right to verify all statements, information and documents submitted by the Applicant in response to the TENDER. Any such verification or lack of such verification by the Authority shall not relieve the Applicant of its obligations or liabilities hereunder nor will it affect any rights of the Authority there under.

**59. The bid shall be rejected if the bidder-**

- a. Stipulates the validity period less than 180 days.
- b. Stipulates own condition/conditions.
- c. Does not fill and (digital) sign undertaking forms, which are incorporated, in the document.

**60. Clarifications**

Applicants requiring any clarification on the tender may notify "the Authority" in writing or by fax or e-mail. They should send in their queries before the date specified in the header data. "The Authority" shall Endeavor to respond to the queries within the period specified therein. The responses will be sent by fax and/or e-mail. The Authority will forward all the queries and its responses thereto, to all purchasers of the TENDER without identifying the source of queries.

"The Authority" shall Endeavour to respond to the questions raised or clarifications sought by the Applicants. However, the Authority reserves the right not to respond to any question or provide any clarification, in its sole discretion, and nothing in this Clause shall

be takeor read as compelling or requiring the Authority to respond to any question or to provideany clarification, but not later than the date provided in header data.

“The Authority” may also on its own motion, if deemed necessary, issue interpretations and clarifications to all Applicants. All clarifications and interpretations issued by the Authority shall be deemed to be part of the tender. Verbal clarifications and information given by Authority or its employees or representatives shall not in any way or manner be binding on the Authority.

#### **61. Amendment of tender**

At any time prior to the deadline for submission of Application, the Authority may, for any reason, whether at its own initiative or in response to clarifications requested by an Applicant, modify the tender by the issuance of Addendum.

Any Addendum thus issued will be sent in writing/ Fax/ Email to all those who have purchased the tender.

In order to afford the Applicants a reasonable time for taking an Addendum into account, or for any other reason, the Authority may, in its sole discretion, extend the Application Due Date.

### **Preparation and Submission of Application**

#### **62. Language**

The Application and all related correspondence and documents in relation to the Bidding Process shall be in English language. Supporting documents and printed literature furnished by the Applicant with the Application may be in any other language provided that they are accompanied by translations of all the pertinent passages in the English language, duly authenticated and certified by the Applicant. Supporting materials, which are not translated into English, may not be considered. For the purpose of interpretation and evaluation of the Application, the English language translation shall prevail.

### **63. Format and signing of Application**

The Applicant shall provide all the information sought under this TENDER. The Authority will evaluate only those Applications that are received in the required formats and complete in all respects. Incomplete and /or conditional Applications shall be liable to rejection. The Applicant will upload bid in One Folder in electronic form which shall contain the scanned certified copies of the documents given below and the documents uploaded has to be digitally signed by the bidder. These copies shall be certified by Practicing Notary approved by the Govt. of Maharashtra or Govt. of India with his stamp, clearly stating hisname& registration number, except where original documents are demanded

### **64. Marking of Applications**

The Applicant shall submit the Application in the format specified at Appendix-I, together with the documents, upload in folder as “VENDOR” together with their respective enclosures.

Applications submitted by fax, telex, telegram shall not be entertained and shall be rejected outright.

### **65. Late Applications**

Applications received by the Authority after the specified time on the Application Due Date shall not be eligible for consideration and shall be summarily rejected.

### **66. Confidentiality**

Information relating to the examination, clarification, evaluation, and recommendation for the short-listed qualified Applicants shall not be disclosed to any person who is not officially concerned with the process or is not a retained professional advisor advising the Authority in relation to or matters arising out of, or concerning the Bidding Process. The Authority will treat all information, submitted as part of Application, in confidence and will require all those who have access to such material to treat the same in confidence. The Authority may not divulge any such information unless it is directed to do so by any statutory entity that has the power under law to require its disclosure or is to enforce or

assert any right or privilege of the statutory entity and/ or the Authority or as may be required by law or in connection with any legal process.

**67. Clarification Of Financial Bids**

To assist in the examination, evaluation and comparison of Bids, the Engineer may, at his discretion, ask any bidder for clarification of his Bid, including breakdown of unit rates. The request for clarification and the response shall be in writing or by post/facsimile/e-mail. No Bidder shall contact the Engineer on any matter relating to his bid from the time of the bid opening to the time the contract is awarded. Any effort by the Bidder to influence the Engineer in the Engineer's bid evaluation, bid comparison or contract award decisions may result in the rejection of the Bidder's bid.

**68. Inspection of site and sufficiency of tender:**

1. The Contractor shall inspect and examine the site and its surrounding and shall satisfy himself before submitting his tender as to the nature of the ground and subsoil (so far as is practicable), the form and nature of the site, the quantities and nature of the work and materials necessary for the completion of the works and means of access to the site, the accommodation he may require and in general shall himself obtain all necessary information as to risk, contingencies and other circumstances which may influence or affect his tender. He shall also take into consideration the hydrological and climatic conditions.
2. The Employer may make available to the Contractor data on hydrological and sub-surface conditions as obtained by or on his behalf from investigations relevant to the works but the Contractor shall be responsible for his own interpretation thereof. The contractor shall engage his investigating agency with prior approval of the Engineer from the approved list of such agencies by Brihanmumbai Municipal Corporation or Govt at his cost initially before commencing actual work and which shall be reimbursed immediately subject to satisfaction of the Engineer for faithful compliance



and submission of required data regarding such investigation within specified time.

3. The Contractor shall be deemed to have satisfied himself before tendering as to the correctness and sufficiency of his tender for the works and of the rates and prices quoted in the schedule of works / items / quantities, or in Bill of Quantities, which rates and prices shall, except as otherwise provided cover all his obligations under the Contract and all matters and things necessary for proper completion and maintenance of the works. No extra charges consequent on any misunderstanding.
4. **Not Foreseeable Physical Obstructions or Conditions:** If, however, during the execution of the Works the Contractor encounters physical obstructions or physical conditions, other than climatic conditions on the Site, which obstructions or conditions were, in his opinion, not foreseeable by an experienced contractor, the Contractor shall forthwith give notice thereof to the Engineer. On receipt of such notice, the Engineer shall, if in his opinion such obstructions or conditions could not have been reasonably foreseen by an experienced contractor, after due consultation with the Contractor, determine:
  - any extension of time to which the Contractor is entitled and
  - The amount of any costs which may have been incurred by the Contractor by reason of such obstructions or conditions having been encountered, which shall be added to the Contract Price, and shall notify the Contractor accordingly.
  - Such determination shall take account of any instruction which the Engineer may issue to the Contractor in connection therewith, and any proper and reasonable measures acceptable to the Engineer which the Contractor may take in the absence of specific instructions from the Engineer. However such costing shall be got approved by the competent authority as governed vide rules prevailing with authority.

**5. Office for the Engineer (Works costing upto Rs.50 Lakhs)**

The Contractor shall at his own cost and to satisfaction of the Engineer provide a small temporary office, at the work-site which will include tables, chairs and lockers for keeping the records. He shall also make necessary arrangements for drinking water, telephone with a pre-requisite of e-governance and electronic communication. These offices are not to be allowed on public roads without the written instruction of the Engineer. These offices should be preferably located within 50 to 500 m of the worksite. In case the office is more than 500m away from the worksite, the contractor is to provide conveyance for Municipal Staff.

**6. Office for the Engineer (Works costing above Rs.50 lakhs)**

The Contractor shall at his own cost and to satisfaction of the Engineer provide a temporary office at the work-site which will include tables, chairs and lockers for keeping the records. He shall also make necessary arrangements for drinking water, latrines, with doors, windows, locks, bolts and fastenings sufficient for security for the Engineer, and his subordinates, as close to the works from time to time in progress as can be conveniently arranged, and shall at his own cost furnish the office with such chairs, tables, lockers, locks and fastenings as may be required by the Engineer, and no expense of any kind in connection with the erection or upkeep of the offices or fittings shall be borne by the Corporation, but all such work shall be carried out by the Contractor and the expenses thereof defrayed by him. The Contractor shall also make water connections and fit up stand pipe with a bib tap at each office. The latrines and the water connections shall be subject to all the conditions herein elsewhere laid down for temporary water connection and latrines generally with all requisite equipments for e-governance and electronic and digital communication. These offices are not to be allowed on public roads without the written instruction of the Engineer. These offices should be preferably located within 50 to 500 m of the worksite. In case the office is more than 500m

away from the worksite, the contractor is to provide conveyance. Also, for staff working beyond working hours the contractor has to provide conveyance.

**7. Permission for provision and removal of office on completion of work:**

The tenderer shall obtain permission for provision of site office, cement go-down, store, etc. on payment of necessary cost implication. The cement go-down, Watchman cabins, etc. shall be provided as directed and shall be removed by the Tenderers on completion of the work at their cost. It is binding on the Tenderer to fulfill requirements of Environmental Authorities. The location of such office shall be finalized and got approved from the Engineer before erection/commencement work.

- 8. Contractor's office near works:** The Contractor shall have an office near the works at which notice from the Commissioner or the Engineer may be served and shall, between the hours of sunrise and sunset on all working days, have a clerk or some other authorized person always present at such office upon whom such notices may be served and service of any notices left with such clerk or other authorized person or at such office shall be deemed good service upon the Contractor and such offices shall have pre-requisite facilities for e-governance.

**69. Official Secrecy:**

The Contractor shall of all the persons employed in any works in connection with the contract that the India Official Secrets Act 1923 (XIX of 1923) applies to them and will continue to apply even after execution of the said works and they will not disclose any information regarding this contract to any third party. The contractor shall also bring into notice that, any information found to be leaked out or disclosed the concern person as well as the Contractor will be liable for penal action; further the Corporation will be at liberty to terminate the contract without notice.

**70. Subsequent Legislation:**

If on the day of submission of bids for the contract, there occur changes to any National or State statute, Ordinance, decree or other law or any regulation or By-laws or any local or other duly constituted authority or the introduction of any such National or State Statute, Ordinance, decree or by which causes additional or reduced cost to the Contractor, such additional or reduced cost shall, after due consultation with the Contractor, be determined by the concerned Engineering Department of Brihanmumbai Municipal Corporation and shall be added to or deducted from the Contract Price with prior approval of competent authority and the concerned Engineering Department shall notify the Contractor accordingly with a copy to the Employer. Brihanmumbai Municipal Corporation reserve the right to take decision in respect of addition/reduction of cost in contract.

**71. Patent, Right and Royalties:**

The contractor shall save harmless and indemnify the Corporation from and against all claims and proceedings for or on account of infringement of any Patent rights, design trademark or name of other protected rights in respect of any constructional plant, machine work, or material used for or in connection with the Works or any of them and from and against all claims, proceedings, damages, costs, charges and expenses whatsoever in respect thereof or in relation thereto. Except where otherwise specified, the contractor shall pay all tonnage and other royalties, rent and other payments or compensation, if any, for getting stone, sand, gravel, clay or other materials required for the works or any of them.

**72. Payments, Tax and Claims:**

- **The limit for unforeseen claims**

Under no circumstances whatever the contractor shall be entitled to any compensation from Brihanmumbai Municipal Corporation on any account unless the contractor shall have submitted a claim in writing to the Eng-in-change within 1 month of the case of such claim occurring.

- **No interest for delayed payments due to disputes, etc:**

It is agreed that the Brihanmumbai Municipal Corporation or its Engineer or Officer shall not be liable to pay any interest or damage with respect of any moneys or balance which may be in its or its Engineer's or officer's hands owing to any dispute or difference or claim or misunderstanding between the Brihanmumbai Municipal Corporation or its Engineer or Officer on the one hand and the contractor on the other, or with respect to any delay on the part of the Brihanmumbai Municipal Corporation or its Engineer or Officers in making periodical or final payments or in any other respect whatever.

### **73. Settlement of Disputes:**

- **Termination of contract for death**

If the Contractor is an individual or a proprietary concern and the individual or the proprietor dies and if the Contractor is a partnership concern and one of the legal representative of the individual Contractor or the proprietor of the proprietary concern and in case of partnership, the surviving partners, are capable of carrying out and completing the contract, the Commissioner shall be entitled to cancel the contract as to its uncompleted part without the Corporation being in any way liable to payment of any compensation to the estate of the deceased Contractor and or to the surviving partners of the Contractor's firm on account of the cancellation of the contract. The decision of the Commissioner that the legal representative of the deceased Contractor or surviving partners of the Contractor's firm cannot carry out and complete the contract shall be final and binding on the parties. In the event of such cancellation the Commissioner shall not hold estate of the deceased Contractor and or surviving partners of the Contractor's firm liable in damages for not completing the contract.

- **Settlement of Disputes:**

If any dispute or differences of any kind whatsoever other than those in respect of which, the decision of any person is, by the Contract, expressed to be final and binding) shall arise between the Employer and the Contractor or the Engineer and the Contractor in connection with or arising out of the Contract or carrying out of the Works (Whether

during the progress of the Works or after their completion and whether before or after the termination, abandonment or breach of the Contract) it, the aggrieved party may refer such dispute within a period of 7 days to the concerned Addl. Municipal Commissioner who shall constitute a committee comprising of three officers i.e. concerned Deputy Municipal Commissioner or Director (ES&P), Chief Engineer other than the Engineer of the Contract and concerned Chief Accountant. The Committee shall give decision in writing within 60 days. Appeal on the Order of the Committee may be referred to the Municipal Commissioner within 7 days. Thereafter the Municipal Commissioner shall constitute a Committee comprising of three Addl. Municipal Commissioners including Addl. Municipal Commissioner in charge of Finance Department. The Municipal Commissioner within a period of 90 days after being requested to do so shall give written notice of committee's decision to the Contractor. Save as herein provided such decision in respect of every matter so referred shall be final and binding upon both parties until the completion of the works, and shall forthwith be given effect to by the Contractor who shall proceed with the works with due diligence, whether he requires arbitration as hereinafter provided or not. If the Commissioner has given written notice of the decision to the Contractor and no Claim to arbitration has been communicated within a period of 90 days from receipt of such notice the said decision shall remain final and binding upon the Contractor.

#### **74. Arbitration and Jurisdiction:**

If the commissioner fails to give notice of the decision as aforesaid within a period of 90 days after being requested as aforesaid or if the contractor is dissatisfied with any such decision, then the contractor may within 90 days after receiving notice of such decision or within 90 days after the expiration of the first named period of 90 days (as the case may be) require that the matter or matters in dispute be referred to arbitration as hereinafter provided.

- i) In case of a contract where the contract price and/ or contract value is less than Rs. 5,00,00,000/- (Rupees Five Crore Only), any dispute arising out of or in connection with this contract, including any question regarding its existence, validity or termination, shall be referred to a mutually agreed arbitral tribunal in accordance with the Arbitration and Conciliation Act, 1996 (amended upto date). The arbitral

tribunal shall consist of a sole arbitrator, as mutually agreed upon by the parties and the said dispute shall be finally resolved by the said arbitral tribunal. The decision of the arbitral tribunal shall be in writing (with reasons) and which will be final and binding upon the parties hereto and the expenses of the arbitration shall be paid as may be determined by the arbitral tribunal. The seat of the arbitration shall be Mumbai. The venue of arbitration shall be within the limits of Brihan Mumbai. The language of the Arbitration shall be English. If the parties fails to appoint mutually agreed arbitral tribunal, within the period of 30 days from the date of application seeking arbitration in the dispute, the arbitral tribunal shall be appointed by the recognised arbitral institution i.e. Mumbai Centre for International Arbitration (approved by Government of Maharashtra under G.R. no. ARB/Case No. 1,/2017/D-19 dtd.28.02.2017) as per the Arbitration Rules of the Mumbai Centre for International Arbitration then in force ("MCIA Rules").

- ii) In case of contract where the contract price and/ .or contract value is Rs 5,00,00,000/- (Rupees five Crore only) or more, any dispute arising out of or in connection with such a contract, including any question regarding its existence, validity or termination, shall be directly referred to and finally resolved by the recognized arbitral institution i.e. Mumbai Centre for International Arbitration (approved by Government of Maharashtra under G.R. no. ARB/Case No. 1,/2017/D-19 dtd.28.02.2017) as per the Arbitration Rules of the Mumbai centre for International Arbitration then in force ("MCIA Rules"). The arbitral tribunal shall consist of a sole arbitrator. The seat of the arbitration shall be Mumbai. The language of the Arbitration shall be English.

In either case, the law governing this arbitration agreement and the contract shall be Indian Law.

**75. Copyright:**

The copyright of all drawings and other documents provided by the Contractor under the contract shall remain vested in the Contractor or his sub-contractors as the case may be the employer shall have a license to use such drawings and other documents in connection

with the design, construction, operation, maintenance of the works. At any time the Employer shall have further license without additional payment to the Contractor to use any such drawings or documents for the purpose of making any improvement of the works or enlargement or duplication of any part thereof, provided that such improvement, enlargement, or duplication by itself or in conjunction with any other improvements, enlargements or duplications already made in accordance with the further license does not result in the duplication of the whole works.

**76. Receipts to be signed in firm's name by any one of the partners:**

Every receipt for money which may become payable or for any security which may become transferable to the Contractor under these present shall, if signed in the partnership name by any one of the partners, be a good and sufficient discharge to the Commissioner and Municipal Corporation in respect of the money or security purporting to be acknowledged thereby, and in the event of death of any of the partners during the pendency of this contract, it is hereby expressly agreed that every receipt by any one of the surviving partners shall, if so signed as aforesaid, be good and sufficient discharge as aforesaid provided that nothing in this clause contained shall be deemed to prejudice or effect any claim which the Commissioner or the Corporation may hereafter have against the legal representatives of any partners so dying or in respect of any breach of any of the conditions thereof, provided also that nothing in this clause contained shall be deemed prejudicial or affect the respective rights or obligations of the Contractors and of the legal representatives of any deceased Contractors interest.

**77. Proprietary data**

All documents and other information supplied by the Authority or submitted by an Applicant to the Authority shall remain or become the property of the Authority. Applicants are to treat all information as strictly confidential and shall not use it for any purpose other than for preparation and submission of their Application. The Authority will not return any Application or any information provided along therewith.



## **78. Correspondence with the Applicant**

Save and except as provided in this TENDER, the Authority shall not entertain any correspondence with any Applicant in relation to the acceptance or rejection of any Application.

## **79. Price Variation Clause (Not Applicable)**

The Contractor shall be reimbursed or shall refund to the Corporation as the case may be the variation in the value of the work carried out from time to time, depending on whether the prices of material and labour as a whole rise or fall, and the method adopted for such computations shall be as given below, it being clearly understood that the contractor shall have no claim for being reimbursed on the ground that the price of a particular material or group of materials have risen beyond the limits of the presumptions made in the following paras, however, no price variations shall be made applicable for contracts up to 12 months:

- A) Controlled materials: Price variations shall be permitted in respect of these materials the price level of which is controlled by the Government or its agency. The rate ruling on the date of submission of the tender shall be considered as the basic price of such material for adjustment. Any variation in this rate shall be considered for reimbursement to the contractor or refund to be claimed from the contractor as the case may be. The contractor shall, for the purpose of adjustment submit in original the relevant documents from the suppliers.
- B) Labour and other materials: For the purpose of this contract and for allowing reimbursement or refund on account of variation of prices of (i) labour, and (ii) materials other than materials mentioned in A above, computation will be based on the formula enunciated below which is based on the presumptions that :
  - i) The general price level of labour, rises or falls in proportion to the rise or fall of consumer price index number 9 (general) for working class in Mumbai.
  - ii) The general price level of materials rises or falls in proportion to rise or fall of whole-sale price index as published by 'Economic Adviser to Govt. of India'.

iii) And that the component of labour is to the extent of 30 percent of 88 percent and the component of materials is to the extent of 70 percent of 88 percent of the value of the work carried out. The remaining 12 percent being the presumptive profit of the contractor.

a) Formula for Labour component:

$$V_L = \frac{(0.88 R) \times 30}{100} \times \frac{(I - I_0)}{I_0}$$

b) Formula for Material component :

$$V_M = \frac{(0.88 R \times 70 - C)}{100} \times \frac{(W - W_0)}{W_0}$$

Where -

$V_L$  = Amount of price variation to be reimbursed or claimed as refund on account of general rise or fall of index referred to above.

$I$  = Consumer Price Index number of working class for Mumbai declared by the Commissioner of Labour and Director of Employment, Mumbai) applicable to the period under reference (base year ending 2004-05 as 100 i.e. new series of indices).

$I_0$  = Consumer price index number for working class for Mumbai (declared by the Commissioner of labour and Director of Employment, Mumbai) prevailing, on the day of 28 days prior to the date of submission of the tender.

$V_M$  = The amount of price variation to be reimbursed or claimed as refund on account of general rise or fall of wholesale price index for period under reference.

$W$  = Average wholesale price index as published by Economic Adviser to Govt. of India applicable to the period under reference.

$W_0$  = Wholesale price index as stated above prevailing on the day of 28 days prior to the date of submission of the tender.

R = Total value of the work done during the period under reference as recorded in the Measurement Book excluding water charges and sewerage charges but including cost of excess in respect of item upto 50 percent

C = Total value of Controlled materials used for the works as recorded in Measurement Book and paid for at original basic rate plus the value of materials used .

- i) The quantity of the Controlled material adopted in working out the value of 'C' shall be inclusive of permitted wastages as / if mentioned in specifications.
- ii) The basic rate for the supply of controlled material shall be inclusive of all the components of cost of materials excluding transport charges incurred for bringing the material from place of delivery to the site.

Computations based on the above formula will be made for the period of each bill separately and reimbursement will be made to (when the result is plus) and refund will claimed from (when the result is minus) the contractor's next bill. The above formulae will be replaced by the formulae in Annexure-I as and when mentioned in special conditions of contract.

The operative period of the contract for application of price variation shall mean the period commencing from the date of commencement of work mentioned in the work order and ending on the date when time allowed for the work order and ending on the date when time allowed for the work specified in the contract for work expires, taking into consideration, the extension of time, if any, for completion of the work granted by Engineer under the relevant clause of the conditions of contract in cases other than those where such extension is necessitated on account of default of the contractor.

The decision of the Engineer as regards the operative period of the contract shall be final and binding on the contractors.

- iii) Where there is no supply of controlled items to contractor the component 'C' shall be taken as zero.
- C) Adjustment after completion: If the Contractor fails to complete the works within the time for completion adjustment of prices thereafter until the date of completion of the works shall be made using either the indices or prices relating to the prescribed time for completion, or the current indices or prices whichever is more favourable to the employer, provided that if an extension of time is granted, the above provision shall apply only to adjustments made after the expiry of such extension of time.
- D) Price variation will be calculated similarly and separately for extra items and / or excess quantities and provisional sums calculated under Sub Clause 10 (b)A i)&(ii) and Sub Clause 10 (b) B(ii) based on the above formula/formulae in Annexure-I as and when mentioned in Special conditions of contract; IO and WO being the indices applicable to the date on which the rates under Sub Clause 10 (a)A (i)&(ii) and Sub Clause 10 (a) B(iii) are fixed. No price variation shall be admissible for FAIR items created during execution.

**80. Maximum Price Variation shall be as follows:**

Time Period of Project	Maximum limit of Price Variation
Up to 12 months	No variation allowed
Above 12 months to 24 months	5%
Above 24 months	10%

**Note:**

- 1) The extension in time period for the projects originally estimated including monsoon results in change of price variation slabs as mentioned above i.e. from first slab to second slab or from second slab to third slab, then the maximum limit of original slab will prevail.

2) Operative period shall mean original or extended time period of contract.

**For example:**

Extension of Time period	Maximum Price Variation
If original period of 11 months including monsoon extends to 16. The operative period will be 11+5 months.	No variation allowed
If original period of 11 months excluding monsoon extends to 16. The operative period will be 11+5 months.	Maximum 5% variation allowed

Price Variation during Extended Period of Contract:

**(i) Extension Due To Modification & Extension for delay due to Brihanmumbai Municipal Corporation:**

The price variation for the period of extension granted shall be limited to the amount payable as per the Indices. In case the indices increases or decreases, above/below the indices applicable, to the last month of the original or extended period vide clause 8 (I) (a) (i) and (ii) of standard GCC.

**(ii) Extension of Time For Delay Due To Contractor :**

(a) The price variation for the period of extension granted shall be limited to the amount payable as per the Indices in case the indices increase, above the indices applicable, to the last month of the original completion period or the extended period vide above clause 8(I)(a)(i) and (ii) of standard GCC.

(b) The price variation shall be limited to the amount payable as per the indices, in case the indices decrease or fall below the indices applicable, to the last month of original / extended period of completion period vide above clause 8(I)(b) of standard GCC, then lower indices shall be adopted.

**(iii) Extension of Time For Delay due to reasons not attributable to Brihanmumbai Municipal Corporation and Contractor (Reference Cl.8(d) of Standard GCC):**

The price variation for the period of extension granted shall be limited to the amount payable as per the Indices in case the indices increases or decreases, above/below the indices applicable, to the last month of the original period.

## **81. Payment:**

### **Interim Payment:**

- i) Interim bills shall be submitted by the Contractor from time to time (but at an interval of not less than one month) for the works executed. The Engineer shall arrange to have the bills verified by taking or causing to be taken, where necessary, the requisite measurement of work.
- ii) Payment on account for amount admissible shall be made on the Engineer certifying the sum to which the Contractor is considered entitled by way of interim payment for all the work executed, after deducting there from the amount already paid, the security deposit / retention money and such other amounts as may be deductible or recoverable in terms of the contract.
- iii) On request, the contractor will be paid upto 75 percent of the value of the work carried out as an adhoc payment in the first week of next month after deducting there from recoveries on account of advances, interest, retention money, income tax etc. The balance payment due will be paid thereafter. (Not Applicable)
- iv) No interim payment will be admitted until such time the Contractor have fully complied with the requirement of the Condition no.8 (g) and 8 (h) concerning submission and approval of Network Schedule for the works, as detailed in Condition 8 (h). A fixed sum shall be held in abeyance at the time of next interim payment for non-attainment of each milestone in the network and shall be released only on attainment of the said milestone.
- v) An interim certificate given relating to work done or material delivered may be modified or corrected by a subsequent interim certificate or by the final certificate.

No certificate of the Engineer supporting an interim payment shall of itself be conclusive evidence that any work or materials to which it relates is / are in accordance with the contract.

**82. Banning/De-Registration of Agencies of Construction works in Brihanmumbai Municipal Corporation**

**The regulations regarding Demotion/ Suspension Banning for specific period or permanently / De-Registration shall be governed as per the respective condition in Contractor Registration Rules of Brihanmumbai Municipal Corporation.**

**83. JOINT VENTURE (Not Applicable)**

- a) A joint venture of not more than two (2) firms / entities may also participate in the bidding. The joint venture entities shall follow the following principles.
- b) Separate identity/name shall be given to the Joint Venture firm.
- c) Number of members in a JV firm shall not be more than two (02).
- d) A member of JV firm shall not be permitted to participate either in individual capacity or as a member of another JV firm in the same tender.
- e) The tender form shall be purchased and submitted in the name of the JV firm or any constituent member of the JV.
- f) Normally EMD shall be submitted only in the name of the JV and not in the name of constituent member. However, EMD in the name of lead partner can be accepted subject to submission of specific request letter from lead partner stating the reasons for not submitting the EMD in the name of JV and giving written confirmation from the JV partners to the effect that the EMD submitted by the lead partner may be deemed as EMD submitted by JV firm.
- g) One of the members of the JV firm shall be the lead member of the JV firm who shall have a majority (at least 51%) share of interest in the JV firm. **The other member shall have a share of not less than 26%.** In case of JV firm with foreign member(s), the lead member has to be an Indian firm with a minimum share of 51%.

- h) A copy of Letter of Intent or Memorandum of Understanding (MoU) executed by the JV members shall be submitted by the JV firm along with the tender. The complete details of the members of the JV firm, their share and responsibility in the JV firm etc. particularly with reference to financial, technical and other obligation shall be furnished in the agreement.
- i) Once the tender is submitted, the agreement shall not be modified /altered/ terminated during the validity of the tender. In case the tenderer fails to observe /comply with this stipulation, the **10%** Earnest Money Deposit (EMD) shall be forfeited. In case of successful tenderer, the validity of this agreement shall be extended till the currency of the contract expires.

**JV member shall not sell / transfer / alter their shares / stakes in the JV during entire validity of the contract including extended period and the defect liability period.**

- j) Approval for change of constitution of JV firm shall be at the sole discretion of the BMC. The constitution of the JV firm shall not be allowed to be modified after submission of the tender bid by the JV firm except when modification becomes inevitable due to succession laws etc. and in any case the minimum eligibility criteria should not get vitiated. In any case the Lead Member should continue to be the Lead Member of the JV firm. Failure to observe this requirement would render the offer invalid.
- k) Similarly, after the contract is awarded, the constitution of JV firm shall not be allowed to be altered during the currency of contract except when modification become inevitable due to succession laws etc. and in any case the minimum eligibility criteria should not get vitiated. Failure to observe this stipulation shall be deemed to be breach of contract with all consequential penal action as per contract condition.
- l) On award of contract to a JV firm, a single Performance Guarantee shall be required to be submitted by the JV firm as per tender conditions. All the Guarantees like Performance Guarantee, Bank Guarantee for Mobilization advance, machinery Advance etc. shall be accepted only in the name of the JV firm and no splitting of guarantees amongst the members of the JV firm shall be permitted.



- m) On issue of LOA, an agreement among the members of the JV firm (to whom the work has been awarded) has to be executed and got registered before the Registrar of the Companies under Companies Act or before the Registrar / Sub-Registrar under the Registration Act, 1908. This agreement shall be submitted by the JV firm to the BMC before signing the contract agreement for the work. (This agreement format should invariably be part of the tender condition). In case the tenderer fails to observe/comply with this stipulation, the full Earnest Money Deposit (EMD) shall be forfeited and other penal actions due shall be taken against partners of the JV and the JV. This joint venture agreement shall have, inter-alia, following clauses:-
- i) **Joint and several liability** - The members of the JV firm to which the contract is awarded, shall be jointly and severally liable to the Employer (BMC) for execution of the project in accordance with General and Special conditions of the contract. The JV members shall also be liable jointly and severally for the loss, damages caused to the BMC during the course of execution of the contract or due to no execution of the contract or part thereof.
  - ii) **Duration of the Joint Venture Agreement** -It shall be valid during the entire period of the contract including the period of extension if any and the maintenance period after the work is completed.
  - iii) **Governing Laws** - The Joint Venture Agreement shall in all respect be governed by and interpreted in accordance with Indian Laws **within jurisdiction of competent court in Mumbai city.**
  - iv) **Authorized Member** -Joint Venture members shall authorize one of the members on behalf of the Joint Venture firm to deal with the tender, sign the agreement or enter into contract in respect of the said tender, to receive payment, to witness joint measurement of work done, to sign measurement books and similar such action in respect of the said tender/contract. All notices/correspondences with respect to the contract would be sent only to this authorized member of the JV firm. No member of the Joint Venture firm shall have the right to assign or transfer the interest right or liability in the contract without the written consent of the other members and that of the employer in respect of the said tender/contract.

- n) **Documents to be enclosed by the JV firm along with the tender :**
- i) In case one or more of the members of the JV firm is/are partnership firm(s), following documents shall be submitted:
    - a. Notary certified copy of the Partnership Deed,
    - b. Consent of all the partners to enter into the Joint Venture Agreement on a stamp paper of appropriate value (in original).
    - c. Power of Attorney (duly registered as per prevailing law) in favour of one of the partners to sign the MOU and JV Agreement on behalf of the partners and create liability against the firm.
  - ii) In case one or more members is/are Proprietary Firm or HUF, the following documents shall be enclosed:
    - a. Affidavit on Stamp Paper of appropriate value declaring that his Concern is a Proprietary Concern and he is sole proprietor of the Concern OR he is in position of "KARTA" of Hindu Undivided Family and he has the authority, power and consent given by other partners to act on behalf of HUF.
  - iii) In case one or more members is/are limited companies, the following documents shall be submitted:
    - a. Notary certified copy of resolutions of the Directors of the Company, permitting the company to enter into a JV agreement, authorizing MD or one of the Directors or Managers of the Company to sign MOU, JV Agreement, such other documents required to be signed on behalf of the Company and enter into liability against the company and/or do any other act on behalf of the company.
    - b. Copy of Memorandum and articles of Association of the Company.
    - c. Power of Attorney (duly registered as per prevailing law) by the Company authorizing the person to do/act mentioned in the para 12.4 above.

- o) All the members of the JV shall certify that they have not been blacklisted or debarred by BMC from participation in tenders/contract in the past either in their individual capacity or the JV firm or partnership firm in which they were members / partners.
- p) **Credentials & Qualifying criteria:** Technical and financial eligibility of the JV firm shall be adjusted based on satisfactory fulfillment of the following criteria:

**Technical eligibility criteria:** The Technical Eligibility Criteria as stipulated in the tender document shall be met either by any one member or by both members of Joint Venture Collectively. However, the lead member of the JV firm shall meet at least 35% requirement of Technical Capacity as stipulated in the tender.

**Financial eligibility criteria:** The average annual contractual payments received by the JV firm or the arithmetic sum of average annual contractual payments received by all the members of JV firm, in proportion to their share in JV, in last three financial years shall be at least 30 % of the estimated value of the work as mentioned in the tender.

#### **84. Compensation for delay:**

If the Contractor fails to complete the works and clear the site on or before the Contract or extended date(s) / period(s) of completion, he shall, without prejudice to any other right or remedy of Municipal Corporation on account of such breach, pay as agreed compensation, amount calculated as stipulated below (or such smaller amount as may be fixed by the Engineer) on the contract value of the whole work or on the contract value of the time or group of items of work for which separate period of completion are given in the contract and of which completion is delayed for every week that the whole of the work of item or group of items of work concerned remains uncompleted, even though the contract as a whole be completed by the contract or the extended date of completion. For this purpose the term 'Contract Value' shall be the value of the work at Contract Rates as ordered including the value of all deviations ordered:

- Completion period for projects (originally stipulated or as extended) not exceeding 6 months :**to the extent of maximum 1 percent per week.**
- Completion period for projects (originally stipulated or as extended) exceeding 6 months and not exceeding 2 years: **to the extent of maximum ½ percent per week.**

- Completion period for projects (originally stipulated or as extended) exceeding 2 years :**to the extent of maximum ¼ percent per week.**

When the delay is not a full week or in multiple of a week but involves a fraction of a week the compensation payable for that fraction shall be proportional to the number of days involved.

Provided always that the total amount of compensation for delay to be paid this condition shall not exceed the undernoted percentage of the Contract Value of the item or group of items of work for which a separate period of completion is given.

- i) Completion period (as originally stipulated or as extended) not exceeding 6 months: **10 percent.**
- ii) Completion period (as originally stipulated or as extended) exceeding 6 months and not exceeding 2 years: **7½ percent.**
- iii) Completion period (as originally stipulated or as extended) exceeding 2 years: **5 percent.**

The amount of compensation may be adjusted set off against any sum payable to the contractor under this or any other contract with the Municipal Corporation.

#### **85. Action And Compensation Payable In Case Of Bad Work And Not Done As Per Specifications**

All works under or in course of execution or executed in pursuance of the contract, shall at all times be open and accessible to the inspection and supervision of the Engineer-in-charge, his authorized subordinates in charge of the work and all the superior officers, officer of the Vigilance Department of the Brihanmumbai Municipal Corporation or any organization engaged by the Brihanmumbai Municipal Corporation for Quality Assurance and the contractor shall, at all times, during the usual working hours and at all other times at which reasonable notice of the visit of such officers has been given to the contractor, either himself be present to receive orders and instructions or have a responsible agent duly accredited in writing, present for that

purpose. Orders given to the Contractor's agent shall be considered to have the same force as if they had been given to the contractor himself.

If it shall appear to the Engineer-in-charge or his authorized subordinates in-charge of the work or to the officer of Vigilance Department, that any work has been executed with unsound, imperfect or unskilful workmanship or with materials of any inferior description, or that any materials or articles provided by him for the execution of the work are unsound or of a quality inferior to that contracted for or otherwise not in accordance with the contract, the contractor shall, on demand in writing which shall be made within twelve months of the completion of the work from the Engineer-in-Charge specifying the work, materials or articles complained of notwithstanding that the same may have been passed, certified and paid for forthwith rectify, or remove and reconstruct the work so specified in whole or in part, as the case may require or as the case may be, remove the materials or articles so specified and provide other proper and suitable materials or articles at his own charge and cost. In the event of the failing to do so within a period specified by the Engineer-in-Charge in his demand aforesaid, then the contractor shall be liable to pay compensation at the same rate as under clause 8.e. of the general condition of contract in section 9 of tender document (for Compensation for delay) for this default. In such case the Engineer-in Charge may not accept the item of work at the rates applicable under the contract but may accept such items at reduced rates as the Engineer in charge may consider reasonable during the preparation of on account bills or final bill if the item is so acceptable without detriment to the safety and utility of the item and the structure or he may reject the work outright without any payment and/or get it and other connected and incidental items rectified, or removed and re-executed at the risk and cost of the contractor. Decision of the Engineer-in-Charge to be conveyed in writing in respect of the same will be final and binding on the contractor.

If the penalisation amount exceeds maximum limit with respect to Clause 8.e of Standard General Conditions of Contract, then a show cause notice shall necessarily be issued to the contract as to why the contract should not be terminated.

**86. Contractors remain liable to pay compensation:**

In any case in which any of the powers conferred upon the Engineer In-charge by the **relevant clauses** in documents that form a part of contract as exercised or is exercisable in the event of any future case of default by the Contractor, he is declared liable to pay compensation amounting to the whole of his security deposit. The liability of the Contractor for past and future compensation shall remain unaffected.

In the event of the Executive Engineer taking action against these relevant clauses, he may, if he so desires, take possession of all or any tools and plant, materials and stores in or upon the work of site thereof or belonging to the Contractor or procured by him and intended to be used for the execution of the work or any part thereof paying or allowing for the same in account at the contract rates, or in the case of contract rates not being applicable at current market rates to be certified by the Executive Engineer, may after giving notice in writing to the Contractor or his staff of the work or other authorized agent require him to remove such tools and plants, materials or stores from the premises within a time to be specified in such notice and in the event of the Contractor failing to comply with any such requisition, the Executive Engineer may remove them at the contractors expense or sell them by auction or private sell on account of the Contractor at his risk in all respects and certificate of the Executive Engineer as to the expense of any such removal and the amount of the proceeds an expense of any such sell be final and conclusive against the Contractor.

**87. No Claim To Any Payment Or Compensation Or Alteration In Or Restriction Of Work**

- (a) if at any time after the execution of contract documents, the Engineer shall for any reason whatsoever, desires that the whole or any part of the works specified in the Tender should be suspended for any period or that the whole or part of the work should not be carried out, at all, he shall give to the Contractor a Notice in writing of such desire and upon the receipt of such notice, the Contractor shall forthwith suspend or stop the work wholly or in part as required after having due regard to the appropriate stage at which the work should be stopped or suspended so as not to

cause any damage or injury the work already done or endanger the safety thereof, provided that the decision of the Engineer as to the stage at which the work or any part of it could be or could have been safely stopped or suspended shall be final and conclusive against the contractor.

The Contractor shall have no claim to any payment or compensation whatsoever by reason of or in pursuance of any notice as aforesaid, on account of any suspension, stoppage or curtailment except to the extent specified hereinafter.

(b) Where the total suspension of Work Order as aforesaid continued for a continuous period exceeding 90 days the contractor shall be at liberty to withdraw from the contractual obligations under the contract so far as it pertains to the unexecuted part of the work by giving 10 days prior notice in writing to the Engineer within 30 days of the expiry of the said period of 90 days, of such intention and requiring the Engineering to record the final measurement of the work already done and to pay final bill. Upon giving such Notice, the Contractor shall be deemed to have been discharged from his obligations to complete the remaining unexecuted work under his contract. On receipt of such notice the Engineer shall proceed to complete the measurement and make such payment as may be finally due to the contractor within a period of 90 days from the receipt of such Notice in respect of the work already done by the contractor. Such payment shall not in any manner prejudice the right of the contractor to any further compensation under the remaining provisions of this clause.

(c) Where the Engineer required to Contractor to suspend the work for a period in excess of 30 days at any time or 60 days in the aggregate, the Contractor shall be entitled to apply to the Engineer within 30 days of the resumption of the work after such suspension for payment of compensation to the extent of pecuniary loss suffered by him in respect of working machinery remained ideal on the site of on the account of his having an to pay the salary of wages and labour engaged by him during the said period of suspension provided always that the contractor shall not be entitled to any claim in respect of any such working machinery, salary or wages for the first 30 days whether consecutive or in the aggregate or such suspension or

in respect of any such suspension whatsoever occasion by unsatisfactory work or any other default on his part, the decision of the Engineer in this regard shall be final and conclusive against the contractor.

**88. Contractor to supply plant, ladder, scaffolding, etc and is liable for damages arising from non provision of lights, fencing, etc.**

The Contractor shall supply at his own cost all material, plant, tools, appliances, implements, ladders, cordage, tackle scaffolding and temporary works requisite or proper for the proper execution of the work, whether, in the original altered or substituted form and whether included in the specification of other documents forming part of the contract or referred to in these conditions or not and which may be necessary for the purpose of satisfying or complying with the requirements of the Eng-In-Charge as to any matter as to which under these conditions is entitled to be satisfied, or which is entitled to require together with the carriage therefore to and from the work.

The Contractor shall also supply without charge, the requisite number of person with the means and materials necessary for the purpose of setting out works and counting, weighing and assisting in the measurements of examination at any time and from time to time of the work or materials, failing which the same may be provided by the Engineer In-charge at the expense of the contractor and the expenses may be deducted from any money due to the contractor under the contract or from his security deposit or the proceeds of sale thereof, or offers sufficient portion thereof.

The contractor shall provide all necessary fencing and lights required to protect the public from accident and shall also be bound to bear the expenses of defence of every suit, action or other legal proceedings, that may be brought by any person for injury sustained owing to neglect of the above precautions and to pay any damages and cost which may be awarded in any such suit action or proceedings to any such person or which may with the consent of the contractor be paid for compromising any claim by any such person.



**89. Prevention of Fire :**

The contractor shall not set fire to any standing jungle, trees, brushwood or grass without a written permit from the Engineer In-charge. When such permit is given, and also in all cases when destroying cut or dug up trees brushwood, grass, etc., by fire, the contractor shall take necessary measure to prevent such fire spreading to or otherwise damaging surrounding property. The Contractor shall make his own arrangements for drinking water for the labour employed by him.

**90.** Compensation for all damages done intentionally or unintentionally by contractor's labour whether in or beyond the limits of Brihanmumbai Municipal Corporation property including any damage caused by spreading the fire shall be estimated by the Engineer In-charge or such other officer as he may appoint and the estimate of the Engineer in-charge to the decision of the Dy. Chief Engineer on appeal shall be final and the contractor shall be bound to pay the amount of the assessed compensation on demand failing which the same will be recovered from the Contractor as damages or deducted by the Engineer In-charge from any sums that may be due or become due from Brihanmumbai Municipal Corporation to contractor under this Contract or otherwise. Contractor shall bear the expenses of defending any action or other legal proceedings that may be brought to prevent the spread of fire and he shall pay any damages and costs that may be awarded by the Court in consequence.

**91.** In the case of Tender by partners, any change in the constitution of the firm shall be forthwith, notified by the contractor through the Engineer In-charge for his information.

**92. Action where no specifications :**

In the case of any class of work for which there is no such specifications, such works shall be carried out in accordance with the specifications and in the event of there being no such specifications, then in such case, the work shall be carried out in all respects in accordance with all instructions and requirements of the Engineer In-charge.

**93. Safety and medical help :**

- (i) The Contractor shall be responsible for and shall pay the expenses of providing medical help to any workmen who may suffer a bodily injury as a result of an accident. If such expenses are incurred by Brihanmumbai Municipal Corporation, the same shall be recoverable from the contractor forthwith and be included without prejudice to any other remedy of Brihanmumbai Municipal Corporation from any amount due or that may become due to the Contractor.
- (ii) The contractor shall provide necessary personal safety equipment and first-aid box for the use of persons employed on the site and shall maintain the same in condition suitable for immediate use at any time.
- (iii) The workers shall be required to use the safety equipments so provided by the contractor and the contractor shall take adequate steps to ensure the proper use of equipments by those concerned.
- (iv) When the work is carried on in proximity to any place where there is risk or drawing all necessary equipments shall be provided and kept ready for use and all necessary steps shall be taken for the prompt rescue of any person in danger.

**94.** No compensation shall be allowed for any delay caused in the starting of the work on account of acquisition of land or in the case of clearance of works, on account of any delay in according to sanction of estimates.

**95. Anti-malaria and other health measures:**

Anti-Malaria and other health measures shall be taken as directed by the Executive Health Officer of Brihanmumbai Municipal Corporation. Contractor shall see that mosquitogenic conditions are created so as to keep vector population to minimum level. Contractor shall carry out anti-malaria measures in the area as per the guidelines issued by the Executive Health Officer of Brihanmumbai Municipal Corporation from time to time.

In case of default, in carrying out prescribed anti-malaria measures resulting in increase in malaria incidence, contractor shall be liable to pay Brihanmumbai Municipal Corporation on anti-malaria measures to control the situation in addition to fine.

**SECTION 10**  
**SPECIAL INSTRUCTIONS TO BIDDERS**

## **SPECIAL INSTRUCTION TO BIDDERS**

1. BMC intends to invite Four (04) separate Bids for treatment of sewage by Bioremediation Technology at Ghatkopar WWTF, Bhandup WWTF, Versova WWTF and Malad WWTF.

The Lagoons at Ghatkopar, Bhandup and Versova WWTF are provided with treatment ponds and floating Aerators arrangement. Malad WWTF is provided with screens and grit chamber facility.

Considering similar nature of WWTFs at Ghatkopar, Bhandup and Versova, it has been decided to allot maximum two (02) contracts to one (01) successful bidder, if he is participating in all the three (03) bids invited for Ghatkopar, Bhandup and Versova WWTF and found lowest responsive in all the three (03) bids. Any two contracts which are the most beneficial to BMC will be awarded to that bidder. The award of contracts will be entirely BMC's discretion.

Considering, different nature of arrangement, the work of Bioremediation at Malad WWTF shall be open to all bidders.

Malad WWTF are provided with screens and grit chamber facility for primary treatment. Other than this, the flow at both the locations is in running condition through closed sewer network with minimal retention time. The contractors will have to consider this aspect while designing their treatment and submitting their bid.

2. It may be noted that the WWTF plant is handed over to the contractual agency appointed by M.S.D.P. department of BMC. It is likely that there will be diversion of flow within the sewer network. The successful contractor has to take into consideration such changes in the working of the plant and design their system accordingly to meet the desired results. The successful bidder will have to work in coordination with the M.S.D.P.'s appointed contractor without any interference to the progress of the M.S.D.P.'s work.
3. Municipal Commissioner reserve right to terminate, annul or foreclose the contract at any stage with 01 month intimation notice. It will be binding on the

part of the contractor and he shall not resort to any remedies like litigation or arbitration or claim compensation of any sort.

4. The payment to the successful contractor shall be made on monthly basis as per due Municipal procedure. The rates invited are for the job work per Million Liters (ML) for a contract period of 02 years. The monthly payment shall be made for the treated flow at actual multiplied by the quoted ML rate. No dosing, no payment.
5. For measurement and billing purpose, the flow indicated on SCADA system of the respective BMC installation will be taken into consideration. If SCADA system is non functional, flow certified by the Executive Engineer of the user department during that period shall be taken into consideration. In case of dispute as regards the measurement of flow, the decision of Ch.E.(S.O.) shall be final.
6. In case of any doubt or dispute the guidelines, mentioned in Standard Bid Document (SBD) and / or the decision of Competent Authority of Brihanmumbai Municipal Corporation will be final.
7. The contractor shall follow all the safety norms as per directives of hon'ble High Court while working on site. In case of any accident due to non-compliance of safety norms / equipment the contractor shall be held responsible.
8. In case of non-compliance of any of the technical requirements, the bid shall be liable to be rejected and Price Packet of the bidder shall not be opened.
9. The treatment of sewage water with Bioremediation technology at various WWTFs is considered as Stop Gap arrangement until the STP plant setup by M.S.D.P. department go fully functional.
10. There will be no obligation / binding on BMC for any patented technology proposed for the subject contract. All the onus in this regard will be borne by the technology provider during all the phases of the tendering and execution of work.
11. Submission of Analytical Model –

The bidder shall submit analytical model of how they are going to achieve the desired effluent parameters by using the proposed technology in Packet 'B' as per the bidding schedule.

The analytical model shall be vetted from the technical advisory Committee (TAC) after opening of Packet A and B and before opening of Packet C.

Tn this regards, the bidder shall give presentation of their technology and analytical model to TAC on how they effluent parameters by using the proposed technology before opening of packet C.

If the analytical model is found to be unsuitable to achieve the desired result and hence, not acceptable by TAC, the corresponding offer will be treated as non-responsive and rejected out-rightly.

**SECTION 11**  
**SPECIFICATIONS**

## SPECIFICATIONS

**Subject:** Rehabilitation of Malad WWTF - Treatment of Sewage Water by Bioremediation Technology.

### A. Objective

Brihanmumbai Municipal Corporation intends to treat the sewage at Malad WWTF by Bioremediation Technology to achieve the desired values of sewage parameters after treatment.

### B. Existing Site Details of Malad WWTF:

1. The sewage water from Malad Pumping Station flows through 1800 mm dia. rising main 2.5 km long.
2. Malad WWTF is having screening and grit chamber arrangement.
3. The installed capacity of the WWTF is 240 MLD
4. The average inlet sewage parameters at Malad WWTF are :

Sr. No.	Parameter	Avg. Dry Weather Values	Avg. Wet Weather Values
1	Flow (MLD)	180 to 200	200 to 250
2	BOD <sub>3/27</sub> (mg/l)	140 to 190	80 to 120
3	COD (mg/l)	300 to 450	200 to 300
4	TSS (mg/l)	90 to 150	150 to 300
5	pH	7 to 7.5	7 to 7.5

The above figures as per the Municipal lab test reports and are only indicative. The above parameters are subject to seasonal changes to the extent of 20 to 30% on either side. The tenderer are requested note the same before quoting and design there system accordingly. The tenderer shall make site survey to get acquainted with the site conditions and collect the requisite data for the treatment to achieve desired results.

5. The site plan of Malad is attached in Section 16.



### C. Desired Outflow Parameters

The desired outflow effluent parameters after treatment shall be as follows:

Sr. No.	Parameter	Desired Value (As per Hon'ble NGT Norms)
1	BOD <sub>3 27</sub> (mg/l)	Shall not exceed 10 mg/l
2	TSS (mg/l)	Shall not exceed 20 mg/l
3	COD (mg/l)	Shall not exceed 50 mg/l
4	pH	6.5 to 9

### D. Scope of Work

The instant work is proposed for treatment of sewage water at Malad WWTF by Bioremediation technology to achieve the sewage effluent discharge parameters as specified by hon'ble NGT. The average flow of Malad WWTF is around 200 MLD . The brief scope of work includes following -

1. Determination of baseline values of inlet sewage parameter.
2. Treatment of sewage with Bioremediation Technology to achieve desired values of outflow sewage parameters after treatment.
3. Supply of microbial product / bio-culture, allied material, dosing system and deployment of required manpower, etc.
4. Provision of Electromechanical infrastructure required for the dosing of microbial / bio-culture.
5. Periodic testing of the sewage samples before and after treatment from the institutions like IIT, VJTI, NEERI or NABL accredited Labs as approved by BMC.
6. State-of-the-art online monitoring system at the outlet of the WWTF.

## **E. Technical Specifications**

1. The successful tenderer shall study the site conditions and characteristics of influent sewage water before finalization of treatment.
2. The successful tenderer shall submit the methodology for the treatment of sewage to achieve the desired results.
3. Considering the existing sewer network of Malad WWTF, the successful tenderer may have to resort to satellite dosing arrangement. These satellite dosing arrangements can be on remote locations or heavy traffic areas or in the areas having higher footfall. The tenderer will have to design their dosing arrangement in such a manner that it will not put the residents or pedestrians or traffic into inconvenient situation.

As such, the tenderers will have to study the sewer network at both the sites and decide on strategic locations for establishing satellite dosing arrangement and shall submit the same along with the tender.

Necessary permission from the regulatory authority shall be obtained by the successful tenderer for establishing the dosing points. Necessary safety arrangement, watch and ward arrangement at the dosing points shall be done by the successful tenderer.

4. The microbial product used for bioremediation process shall be eco-friendly, non-toxic, non-pathogenic, non-contagious and non-corrosive and should not pose any health risk to human, animal and ecosystem and shall fulfil IITR norms and tender requirements.
5. The microbial product shall be native and suitable for Indian ecological system.
6. The product should be able to reduce the polluting parameters for meeting the desired discharge standard for BOD, COD, TSS and pH in Aerobic or Facultative conditions in WWTFs.
7. All the electromechanical and civil structures erected for the Bioremediation treatment shall be of temporary nature and the same shall be removed and

taken after successful completion of the contract period and site condition shall be restored.

8. No Engineering changes shall be allowed site.
9. No civil construction works are allowed at sites except for storage of microbial product after mandatory compliances.
10. Treatment at satellite sites shall be allowed. Satellite dosing point will be decided by the bidder in coordination with the Engineer of Contract.
11. The treatment of sewage water shall be done on 'As is where is basis'.
12. The bidder shall assess and study the site conditions precisely and design the scheme for treatment by Bioremediation Technology to achieve the desired outflow parameters.
13. All the requisite arrangements, including water and electricity, for achieving the desired output results shall be made by the successful contractor by strictly adhering to all the technical specifications, terms and conditions of the tender

**F. Eco-Toxicity Certificate**

- i) The microbial product used must have Eco-toxicity certificate from the Central Govt. Research Lab, Govt. of India or Institute like Indian Institute of Toxicology Research (IITR), Govt. of India and upload all the relevant papers in Packet 'B'.
- ii) The successful tenderer shall carry out the following tests recommended by IITR on the proposed microbial product.

Sr. No.	Name of the Test / Toxicity Studies
1.	Fresh Water Algae and Cyanobacteria Growth Inhibition Test
2.	Fish Acute Toxicity Test
3.	Fish Embryo Acute Toxicity Test
4.	Daphnia Magna Reproduction Test

5.	Fish Early Life Stage Toxicity Test
----	-------------------------------------

The test result shall be submitted within 90 days of award of contract, failing which the Work Order / Letter of Acceptance / P.O. will be cancelled without any legal or financial obligations on BMC and the contract will be terminated as per due procedure

- iii) The microbial product shall comply with all the statutory requirements and permissions from Research Institutes of Government of India so that the use of such products will not harm eco-system on Indian soil considering human safety, terrestrial environment, aquatic life, marine life, biodiversity, etc. The bidder shall upload necessary documents in this regard in Packet 'B'.
- iv) In case of non-compliance of the above requirements of eco-toxicity clause as mentioned above at point (i) to (iv), their offer will be treated as non-responsive.

**G. Manpower Requirement**

The system shall be monitored 24x7 throughout the contract period. The successful contractor shall provide minimum supervising and labour staff at MaladWWTF not limited to the following.

Sr. No.	Manpower Required	Qualification	Nos.
1	Technical	Graduate / Post Graduate in Environmental Science / Engineering	01
2	Supervising	Graduate in any field	01 in each shift of 08 hours
3	Labour	-	01 in each shift of 08 hours

**H. Declarations to be provided(On Rs 500 stamp paper duly notarised)**

The following declarations to be provided by the product manufacturer:

- 1. The microbes in product belong to GRAS (Generally Recognized as Safe) category
- 2. Microbes in the product are non-GMO (Genetically Modified Organism)

3. The microbial product contains only Native microbes
4. The microbial product to be Eco-friendly, Non-toxic, Non-pathogenic, Non-contagious and Non-corrosive and should not pose any health risk to human, animal and ecosystem.

**I. Contract Period**

The contract period for the subject work is 02 years (24 months) inclusive of all seasonal conditions.

**J. Timeline for Achieving Desired parameters**

**Phase A: Mobilization Period - 20 Days**

Within 20 days of award of contract (Date of issue of LOA) or as notified by the Engineer of Contract, the successful bidder shall establish entire set up required for the treatment and commence the dosing and associated activities at all the approved locations.

**Phase B: Stabilization Period- 60 Days**

1. The stabilization period will start immediately after mobilization period of 20 days or start of dosing at all the approved locations, whichever is earlier.
2. Achieve **40%** reduction of the inlet / baseline parameter within first **25 days** from the date of start of stabilization period.
3. Achieve **70%** reduction of the inlet / baseline parameter within first **40 days** from the date of start of stabilization period.
4. Achieve the targeted parameter values as per the contract within **60 days** from the date of start of stabilization period.

**Phase C: Post Stabilization Period**

- i) After stabilization period of 60 days, maintain the target parameters throughout the contract period.

## **K. Testing**

1. The sample at inlet shall be taken from the common header / inlet chamber / screen chamber or as the case may be. After treatment, the composite sample shall be collected and tested for the sewage characteristics. After treatment sampling shall be done just after the WWTF facilities.
2. If it is observed that the values of the parameters after treatment are deviated beyond acceptable limit after stabilisation of the system, additional testing may be insisted and shall be carried out as per the instructions of BMC. The cost towards the same shall be borne by the successful bidder.
3. If the desired results are not achieved, the successful contractor shall take timely corrective measures depending upon the test results and stabilize the system within shortest possible time.
4. The successful contractor shall test the sewage parameters before and after treatment weekly from the institutions like IIT, VJTI, NEERI or NABL accredited Labs as approved by BMC simultaneously in two independent labs or institutions and submit the report to the office of Executive Engineer (Sewerage Operation) Western Suburb.
5. The successful contractor shall test the sewage parameters before and after treatment every three months from the institutions like IIT, VJTI, NEERI and submit the report to the office of Executive Engineer (Sewerage Operation) Western Suburb.
6. All the cost towards sample collection, transportation, testing, etc. shall be borne by the successful bidder.

## **L. Methodology for Collection of Samples**

Methodology for collection of samples based on the relevant standard viz. IS-3025 (Part 1) – 1987 is as follows. In case of any doubt or dispute, the concerned are

requested to refer the relevant clauses of IS: 3025 (Part 1) - 1987 or its latest version for clarification and guidelines, if any.

1.	<b>Location of Sample to be Collected</b>	<ul style="list-style-type: none"> <li>• The Sample at inlet shall be collected at common header/ inlet chamber/ screen chamber or on upstream of first dosing point.</li> <li>• The Effluent Sample shall be collected at the outlet of each stream/ common stream just after the WWTF facilities and shall be composited.</li> <li>• The sample should be collected in bottles up to the brim and water sealed (no air bubble) with inner cap.</li> </ul>
2.	<b>Use of Appropriate Container</b>	<ul style="list-style-type: none"> <li>• The sample shall be collected in a leak proof glass or plastic container.</li> <li>• The container in which the sample is stored and the stopper should not:               <ul style="list-style-type: none"> <li>a) Be a cause of contamination.</li> <li>b) Absorb or adsorb the constituent to be determined.</li> <li>c) React with certain constituents in the sample.</li> </ul> </li> <li>• The new containers shall be thoroughly cleaned in order to minimize possible contamination of the sample.</li> </ul>
3.	<b>Labelling</b>	<ul style="list-style-type: none"> <li>• The sample bottles shall be carefully labelled to provide the following information:               <ul style="list-style-type: none"> <li>a) Place / Location of Sampling</li> <li>b) Time and date of sampling</li> <li>c) Type of Sampling</li> <li>d) Name of Sampling Staff</li> <li>e) Purpose of Sampling</li> <li>f) GPS : Location</li> <li>g) Signature of BMC staff</li> </ul> </li> <li>• The collected sample shall be labeled using wax pencil or permanent marker to protect from wetting.</li> <li>• Sampling photograph with location, date and time shall be recorded.</li> </ul>

4.	<b>Type of Sampling / Technique</b>	<ul style="list-style-type: none"> <li>• Flow proportional samples collected are representative of the bulk water quality. If both the flow and composition vary, flow proportional samples can reveal such variations which may not be observed by the use of spot samples. Accordingly, this is the most precise method of sampling flowing water, if both the flow rate and the concentration of pollutants of interest vary significantly.</li> </ul> <p>As such, this method shall be used for sampling of sewage water for the subject works.</p> <ul style="list-style-type: none"> <li>• Sample collection shall be by 'Grab Composite Method' in which sample shall be collected every 4 hrs interval over a period from 08:00 AM to 08:00 PM.</li> <li>• Immerse the sampling container at least 0.5 m below the surface water level and draw the sample. Rinse the container twice with the waste water being collected and then collect the sample.</li> </ul>
5.	<b>Volume of Sample</b>	<ul style="list-style-type: none"> <li>• Sample volume of 1 litre for every time interval shall be collected and shall be stored in ice box/refrigerator (&lt; 4<sup>0</sup>c) and later mixed in container a common suitable capacity mixing container for composite sampling.</li> </ul>
6.	<b>Sample Preservation</b>	<ul style="list-style-type: none"> <li>• Sample shall be preserved as specified in latest revision of IS : 3025 (Part 1) – 1987.</li> </ul>
7.	<b>Sampling Device</b>	<ul style="list-style-type: none"> <li>• A sufficiently heavy sampling bottles stainless steel container/ brackets should be used to overcome buoyancy.</li> </ul>
8.	<b>Transportation of Sample</b>	<ul style="list-style-type: none"> <li>• The individual wastes tend to decompose on keeping, which result in change of composition at room temperature. Following measures shall be adopted while transporting the sample.</li> </ul>



		<p>a) The samples should be collected in leak proof container.</p> <p>b) Sample should be transported in an ice box keeping the temperature around 4<sup>0</sup>C.</p> <p>c) Immediately after reaching the destination (Testing Laboratory), the sample should be stored in refrigerator.</p>
--	--	--

The contractors shall note and follow the above methodology for collection of samples scrupulously.

**M. Facilities for the Work Force Deployed**

The personnel deployed on this work shall be provided the following facilities.

- i) Two Uniform per annum.
- ii) A set of Hand Gloves, helmet, Face Mask, fluorescent jacket and safety shoes/ gumboot, hand wash, napkin, First Aid box, etc. shall be provided.
- iii) The contractor shall ensure that his Employees shall wear the uniforms and use safety gears while on duty.
- iv) All the personnel appointed by the contractor for the said work shall be adequately insured as per the prevailing laws in force. The contractor shall abide by all the statutory laws applicable for the said work.

**N. Payment Term**

Sr. No.	Description	Payment Terms
1	<b>Phase A (Mobilization Period)</b>	<ul style="list-style-type: none"> <li>• No payment shall be given during mobilization period of 20 days or before start of dosing at all the approved locations.</li> </ul>

Sr. No.	Description	Payment Terms
2	<p><b>Phase B</b> <b>(Stabilization Period)</b></p>	<ul style="list-style-type: none"> <li>• If dosing is not started at all the approved locations, no payment shall be made.</li> <li>• The payment shall be made on achievement of desired target parameters after treatment as per due Municipal procedure.</li> <li>• The payment for the period from start of stabilization period up to achievement of desired target parameters shall be made on volumetric basis for the treated flow in Million Liter (ML) at actual during that period multiplied by the quoted ML rate in aggregated manner.</li> <li>• The bills shall be accompanied with the laboratory test reports and flow data for that period certified by the Executive Engineer of the user department.</li> </ul>
3	<p><b>Phase C</b> <b>(Post Stabilization Period)</b></p>	<ul style="list-style-type: none"> <li>• On satisfactory achievement of desired outflow results, within 30 days from the submission of monthly running bills as per due Municipal procedure.</li> <li>• The monthly payment shall be made on volumetric basis for the treated flow (ML) at actual for the respective month multiplied by the quoted ML rate.</li> <li>• The monthly bills shall be accompanied with the laboratory test reports and flow data for the month certified by the Executive</li> </ul>

Sr. No.	Description	Payment Terms
		<p>Engineer of the user department.</p> <ul style="list-style-type: none"> <li>• <b>If any of the target parameters are beyond limits, the contractor shall not be liable for any payment during the period from date of detection of non-compliance of targeted values till achievement of targeted values supported by laboratory test reports.</b></li> </ul>

**O. Penalty**

Sr. No.	Description	Penalty
1	<p><b>Phase A</b> <b>(Mobilization Period)</b></p>	<ul style="list-style-type: none"> <li>• During the mobilization period of 20 days no penalty will be levied.</li> <li>• If dosing is not started at the approved location within mobilization period of 20 days, penalty of Rs. 10,000/- per day till start of dosing at all approved locations will be levied.</li> </ul>
2	<p><b>Phase B</b> <b>(Stabilization Period)</b></p> <p>For not meeting the desired discharge standard within stipulated time period of 70 days.</p>	<ul style="list-style-type: none"> <li>• Rs. 10,000/- per day till achievement of desired discharge standards.</li> <li>• A grace period of 14 days in addition to 60 days stabilization period shall be given to stabilize the system.</li> <li>• The contractor shall be given 1<sup>st</sup> Notice of non-satisfactory performance towards the end of the stabilization period of 60 days in which they shall be given 07 days grace period.</li> <li>• Towards the end of the 07 days grace period, if</li> </ul>

Sr. No.	Description	Penalty
		<p>it is observed that the system is not stabilized, the contractor will be served 2<sup>nd</sup> Notice of non-satisfactory performance and further grace period of 07 days shall be given to the contractor.</p> <ul style="list-style-type: none"> <li>• Under these circumstances, on 8<sup>th</sup> day, the matter will be referred to Technical Committee formed for the subject work for review of the situation.</li> <li>• Beyond 14 days, it will be contemplated to take action as deemed fit as per the set procedure including forfeiture of Security Deposits, Performance Guarantee and Annulment of Contract which shall be binding on the contractor.</li> </ul>
3	<p><b>Phase C</b> <b>(Post Stabilization Period)</b></p> <p>For not meeting the desired discharge standard</p>	<p><b>Considering Working Conditions with or without shock loads:</b></p> <ul style="list-style-type: none"> <li>• If weekly lab test report values are found deviated from the desired values, a period of 14 days shall be given to re-stabilize the system.</li> <li>• The contractor shall be given 1<sup>st</sup> Notice of non-satisfactory performance on the day of notification of deviations in the desired outflow parameters and a period of 07 days shall be given to re-stabilize the system.</li> <li>• Within 07 day, the sample will be collected and</li> </ul>

Sr. No.	Description	Penalty
		<p>sent for testing as per due procedure.</p> <ul style="list-style-type: none"> <li>• Towards the end of the 07 day grace period, if it is observed that the system is not stabilized, the contractor will be served 2<sup>nd</sup> Notice of non-satisfactory performance and further grace period of 07 days shall be given to the contractor.</li> <li>• On 8<sup>th</sup> day, the matter will be referred to Technical Committee formed for the subject work for review of the situation.</li> <li>• On issuance of second notice, the contractor shall be directed to submit their explanation for non-performance within 03 days positively and the explanation received from the contractor will be submitted to the Technical Committee for review.</li> <li>• The Technical Committee will review the situation and submit their report to BMC within 10 working days.</li> <li>• Beyond 14 days, if still the desired outflow parameters are not received then based on the recommendations of the Technical Committee, it will be contemplated to take action as deemed fit as per the set procedure including forfeiture of Security Deposits, Performance Guarantee and Annulment of Contract which shall be binding on the contractor.</li> </ul>

Sr. No.	Description	Penalty
		<ul style="list-style-type: none"> <li>• Under such circumstances - No payments shall be made for the period from date of detection of deviations from the targeted values till achievement of targeted values supported by laboratory test reports.</li> <li>• In addition to this a penalty of Rs. 10,000/- per day from the date of detection of deviation in desired outflow parameters shall be levied till achievement of targeted values.</li> </ul>
4	<b>Failure to notify deviations from desired outflow parameters</b>	<p>The contractor shall notify any deviation from the desired outflow parameters immediately from the date of detection to BMC, failing which, penalty amounting to Rs. 20,000/- per day will be levied till notification of such deviations to BMC.</p> <p>This penalty shall be levied over and above the penalty for deviation observed in the desired outflow parameters.</p>
5	Supervisory and labour Staff not reporting on duty	Rs. 2000/- per staff per day
6	For not following instruction, safety norms.	Rs. 5000/- per instant
7	Not wearing uniforms and personal protective gears	Rs. 500/- per instant per person
8	For damaging Municipal property.	Rs. 5000/- per instant in addition to making good of the damaged property at his own cost.
9	Not restoring site after completion of contract	No penalty for first 10 working days.

Sr. No.	Description	Penalty
	period.	Thereafter, Rs. 5000/- per day penalty shall be levied till restoration of site.
10	Damage Notices	The contractor shall make payment towards any damage notices issued by Authorities like NGT, CPCB, MPCB and any Government Body or Undertaking.

**P. Foreclosure of Contract**

The contractor shall strictly follow the timeline given for achieving the desired results as defined in Para J of Section 11: Specification and the grace period given for achievement of desired parameters after stabilization and also during post stabilization period.

For a continuous deviation of 14 days in achieving the desired outflow parameters, action as deemed fit as per the set procedure including forfeiture of Security Deposits, Performance Guarantee and foreclosure of Contract will be applicable and shall be binding on the contractor.

**Q. General Requirement**

**1. Specification**

These specifications are intended for general description of site conditions, scope of work and requirements, products, execution, quality of workmanship and finished work. They are not intended to cover minute details. The work shall be executed in accordance with best modern practices and using special techniques.

The Contractor shall read this Technical Specification in conjunction with the standard specification of the Brihanmumbai Municipal Corporation for Sewerage Works and other documents and technical manual, papers, guidelines, standards and specification etc. referred to in the specification. For Civil, Mechanical & Electrical works, Brihanmumbai Municipal Corporation's respective standard specifications shall

be applicable during execution of the project. Bidders are requested to get acquainted with the same before bidding.

## **2. Contractor's Obligation**

The clauses in this section are meant to provide general guidelines and compliance requirements to the Contractor. It does not however relieve the Contractor from (a) taking all precautions as deemed necessary to complete the work successfully within the specified contract period and bided amount and (b) his prima facie obligation and responsibility under the contract to successfully execute the work without causing interruptions to road and pedestrian traffic.

It is deemed that the Contractor's rates in the Bill of Quantities are for successfully execution of work activities included in the scope of works within the specified contract period regardless of the method considered as suitable in this specification.

## **3. Contractor's responsibility of ascertaining extent of work**

The Contractor is deemed to have visited the sites and familiarised himself of the conditions, restrictions and constraints as well as any differences from drawing etc. under which the work will be executed. The omission of any details shall not relieve the Contractor of his prima facie obligation and responsibility under the Contract to carry out and successfully complete the works. No monetary or other claims, made by the Contractor on the grounds of want of knowledge will be entertained by the Employer.

The Contractor is advised that it is his sole responsibility to ascertain for himself the extent of work that is required to be done in site and to generally obtain his own information on all matters affecting directly or indirectly the execution of the whole works involved in the contract to the complete satisfaction of the Engineer. No claim of extras in consequence of any alleged ignorance in any aspect will be entertained by the Engineer. It must be clearly and definitely understood that the contractor shall be held solely responsible for making all necessary arrangement and coordination with



relevant authorities, competent agencies and specialist contractor's principals and technology providers, etc., and obtaining necessary permissions in time by paying all the applicable, to ensure satisfactory completion of the Contract.

#### **4. Performance Requirements**

The performance requirements are spelt out in various parts of the contract specification and the Contractor shall ensure that he fully understands and complies with all the requirements specified in the contract. However, in the event of any conflicting performance requirements in the documents, the Contractor shall promptly bring such matters in writing to the attention of the Engineer for a clarification and/or decision. The Engineer's decision will be conveyed to the Contractor in writing and his decision shall be final. The Contractor shall fully comply with Engineer's decision on the matter.

The Contractor is deemed to have studied site conditions, adequacy / suitability of the methodology to be proposed, read and understood all the performance requirements before pricing the Contract and he shall have no claim whatsoever with respect to the Engineer's final decision on the matter.

#### **5. Rates to include all method related costs**

It is deemed that the rates offered by the Contractor are inclusive of everything required to comply with all the required provisions as above and any additional requirements as necessary to carry out the work safely and successfully. The Contractor is also deemed to have considered for any method related contingencies in his rates. Innovation in relation to the best specified methodology and the best practice is encouraged and the Employer will consider all the options to get the best methodology at competitive price. Hence, sufficient documentation must be submitted to enable the Employer to carry out an initial investigation and appraisal of the product and the method offered and to ascertain the benefit and the advantage of the methodology to the Employer.

#### **6. Co-operation with other Contractors and operational facility**

The Contractor is advised that there may be other Contractors (i.e. from PWD, MMRDA, other department of Brihanmumbai Municipal Corporation or other authorities like Metro, MGL, Private Utility Providers, etc.) working within the site area. The Contractor may therefore be given joint possession, in some sections of the sites, with the other Contractors for the purpose of carrying out his contractual obligation and he shall in no way interfere with, impede or otherwise prevent these other Contractors, from carrying out their contractual obligations. The contractor shall coordinate with all such contractors / agencies and plan / liaison his activities for successful and timely completion of his contract. The Contractor shall allow in his prices, when bidding, for affording reasonable facilities to the other Contractors and for any interference with his work from these other contract operations.

No claim on account of this clause will be entertained by the Brihanmumbai Municipal Corporation and his prices are to include for such contingency.

The contractor shall note that it is the responsibility of the contractor to co-ordinate and arrange meetings with Utility Companies or the Government or Municipal departments. The Corporation would arrange to give authority letters to the contractor for arranging such meetings. The Engineer's representative shall be present in such meetings. The Corporation is not contractually bound to accept what transpired in any meetings or discussions in which the Engineer or the Corporation was not represented.

## **7. Transport of Materials**

It shall be noted by the Contractor that the transport of the equipment's and materials and movement of vehicles overland will be subject to regulation of transport by various statutory authorities. The same will be applicable for materials and equipment's required to be imported for the contract. The Contractor's rates/prices shall include for all costs arising from the imposition of traffic hours restriction by the Traffic Police, import export duties and other shipping charges as applicable. The Bidder is advised to obtain accurate information from the concerned authorities before bidding for the work.

## **8. Assistance for the Engineer's Staff**

The Contractor shall provide all necessary assistance to the Brihanmumbai Municipal Corporation /Engineer's Representative and his staff in carrying out their duties of checking the setting-out, inspecting and measuring the works. The Contractor shall provide chainmen, staff-men, office attendants and labourers as may be needed from time to time by the Engineer's Representative. One labourer shall be deployed at all times at the Engineer's site office to assist the Engineer.

The Contractor shall provide for the Engineer's Representative and his staff such protective clothing, safety helmets and rubber boots of suitable sizes, hand lamps and the like as may be reasonably required by them. These articles shall remain the property of the Contractor.

## **9. Use of I.S. Specifications**

In case no particular specification is given for any work to be done under the contract, the relevant specifications, where exists, of the Indian Standard Institutions shall apply.

## **10. Claims for Damage to Persons or Property**

Any claim received by the Employer in respect of matters in which the Contractor is required under the Contract to indemnify the Employer will be passed to the Contractor who shall likewise inform the Employer of any such claim which is submitted directly to him by a claimant.

The Contractor shall do everything necessary, including notifying the insurers of claims received, to ensure that all claims are settled properly and expeditiously and shall keep the Employer informed as to the progress made towards settlement, failing which the Employer shall be entitled to make direct payment to claimants of all outstanding amounts due to them in the Employer's opinion and without prejudice to any other method of recovery to deduct by way of set-off the amounts so paid from sums due or which become due from the Employer to the Contractor.

If the Contractor receives a claim which he considers to be in respect of matters for which he is to be indemnified by the Employer under the Contract he shall immediately pass such claim to the Employer. All information as aforesaid shall be given in writing and shall be copied to the Engineer's Representative.

#### **11. Existing Services**

The Contractor shall take all due care and necessary precautionary measures to ensure that no damage occurs to any existing sewer, water or gas mains, electricity or telephone cables culverts and any other existing services. Any damage arising out of the Contractor's work in such respect will be met with entirely by the Contractor and no claim to the contrary will be entertained by the Corporation.

#### **12. Method of Working**

The Contractor is required to carry out the Works in the manner detailed herein, shown on the drawings and normally adopted. He is at liberty to supply with his Bid such modification as he proposes for consideration and shall seek approval from the Engineer before he is allowed to apply new or changed methods for execution of the work. Notwithstanding any Specification, approval of decision given by the Engineer as to the carrying out of the Works, the Contractor will be wholly liable for the safety of the works, both temporary and permanent and for the completion of the Contract to the satisfaction of the Engineer.

#### **13. Reference Documents and Standards**

The contractor shall execute the whole and every part of the work in most substantial and workmen like manner, both as regards to materials and otherwise in every respect in strict accordance with Brihanmumbai Municipal Corporation specification latest edition, relevant WRc, WIS, ASTM, BIS, ISI, CPHEEO and other relevant specifications etc. as may be specifically provided for.

## SELECTION OF MATERIAL

1. All materials brought on the site of work and meant to be used in the same, shall be the best of their respective kinds and to the approval of the Engineer. The Engineer or his representative will accept that the materials are really the best of their kinds, when it is proved beyond doubt that no better materials of the particular kind in question are available in the market.
2. The contractor shall obtain the approval of the Engineer of samples of all materials to be used in the works and shall deposit these samples with him before placing an order for the materials with the suppliers. The materials brought on the works shall conform in every respect to their approved samples. Fresh samples shall be deposited with the Engineer whenever the type or source of any material changes.
3. The contractor shall check each fresh consignment of materials as it is brought to the site of works to see that they conform in all respects to the Specifications of the samples approved by the Engineer, or both.
4. The Engineer will have the option to have any of the materials tested to find out whether they are in accordance with the Specifications and the Contractor will bear all expenses for such testing. All bills, vouchers and test certificates, which in the opinion of the Engineer or his representative are necessary to convince him as to the quality of the materials or their suitability shall be produced for his inspection when required.
5. Any materials that have not been found to conform to the specifications will be rejected forthwith and shall be removed from the site by the contractor at his own cost within 24 hours.
6. The Engineer shall have power to cause the Contractors to purchase and use such materials from any particular source, as may in his opinion be necessary for the proper execution of the work.
7. Notwithstanding the source, the sand shall be washed using sand washing machine before use.

**SECTION 12**  
**FRAUD AND CORRUPT PRACTICES**

## FRAUD AND CORRUPT PRACTICES

- The Applicants and their respective officers, employees, agents and advisers shall observe the highest standard of ethics during the Bidding Process. Notwithstanding anything to the contrary contained herein, the Authority may reject an Application without being liable in any manner whatsoever to the Applicant if it determines that the Applicant has, directly or indirectly or through an agent, engaged in corrupt practice, fraudulent practice, coercive practice, undesirable practice or restrictive practice in the Bidding Process.
- Without prejudice to the rights of the Authority under relevant Clause hereinabove, if an Applicant is found by the Authority to have directly or indirectly or through an agent, engaged or indulged in any corrupt practice, fraudulent practice, coercive practice, undesirable practice or restrictive practice during the Bidding Process, such Applicant shall not be eligible to participate in any tender or RFQ issued by the Authority during a period of 2 (two) years from the date such Applicant is found by the Authority to have directly or indirectly or through an agent, engaged or indulged in any corrupt practice, fraudulent practice, coercive practice, undesirable practice or restrictive practice, as the case may be.
- For the purposes of this Clause, the following terms shall have the meaning hereinafter respectively assigned to them:
  - A. **“corrupt practice”** means the offering, giving, receiving, or soliciting, directly or indirectly, of anything of value to influence the actions of any person connected with the Bidding Process (for avoidance of doubt, offering of employment to, or employing, or engaging in any manner whatsoever, directly or indirectly, any official of the Authority who is or has been associated in any manner, directly or indirectly, with the Bidding Process or the LOA or has dealt with matters concerning the Concession Agreement or arising there from, before or after the execution thereof, at any time prior to the expiry of one year from the date such official resigns or retires from or otherwise ceases to be in the service of the

Authority, shall be deemed to constitute influencing the actions of a person connected with the Bidding Process); **or**

save and except as permitted under the relevant sub clause, engaging in any manner whatsoever, whether during the Bidding Process or after the issue of the LOA or after the execution of the Concession Agreement, as the case may be, any person in respect of any matter relating to the Project or the LOA or the Concession Agreement, who at any time has been or is a legal, financial or technical adviser of the Authority in relation to any matter concerning the Project;

- B. “fraudulent practice”** means a misrepresentation or omission of facts or suppression of facts or disclosure of incomplete facts, in order to influence the Bidding Process;
- C. “coercive practice”** means impairing or harming or threatening to impair or harm, directly or indirectly, any person or property to influence any persons participation or action in the Bidding Process;
- D. “undesirable practice”** means (i) establishing contact with any person connected with or employed or engaged by the Authority with the objective of canvassing, lobbying or in any manner influencing or attempting to influence the Bidding Process; or (ii) having a Conflict of Interest; and
- E. “Restrictive practice”** means forming a cartel or arriving at any understanding or arrangement among Applicants with the objective of restricting or manipulating a full and fair competition in the Bidding Process.
- F.** If the Employer/Financier determines that the Contractor has engaged in corrupt, fraudulent, collusive, coercive or obstructive practices, in competing for or in executing the Contract, then the Employer may, after giving 14 days’ notice to the Contractor, terminate the Contractor’s employment under the Contract and expel him from the Site, and the provisions of relevant Clause shall apply as if such expulsion had been made.



- G.** Should any employee of the Contractor be determined to have engaged in corrupt, fraudulent, collusive, coercive, or obstructive practice during the execution of the Works, then that employee shall be removed in accordance with relevant Clause.

For the purposes of this Sub-Clause:

- i. “corrupt practice” is the offering, giving, receiving to soliciting, directly or indirectly, of anything of value to influence improperly the actions of another party;
- ii. “Anotherparty” refers to a public official acting in relation to the procurement process or contract execution. In this context, “public official” includes Financer staff and employees of other organizations taking or reviewing procurement decisions.
- iii. “fraudulent practice” is any act or omission, including a misrepresentation, that knowingly or recklessly misleads, or attempts to mislead, a party to obtain a financial or other benefit or to avoid an obligation;
- iv. “collusive practice” is an arrangement between two or more parties designed to achieve an improper purpose, including to influence improperly the actions of another party;
- v. “coercive practice” is impairing or harming, or threatening to impair or harm, directly or indirectly, any party or the property of the party to influence improperly the actions of a party;
- vi. “obstructive practice” is deliberately destroying, falsifying, altering or concealing of evidence material to the investigation or making false statements to investigators in order to materially impede the Financier investigation into allegations of a corrupt, fraudulent, coercive or collusive practice; and/or threatening, harassing or intimidating any party to prevent it from disclosing its knowledge of matters relevant to the investigation or from pursuing the investigation; or

- vii. acts intended to materially impede the exercise of the Financer's inspection and audit rights provided .
- viii. "party" refers to a public official; the terms "benefit" and "obligation" relate to the procurement process or contract execution; and the "act or omission" is intended to influence the procurement process or contract execution.
- ix. "parties" refers to participants in the procurement process (including public officials) attempting to establish bid prices at artificial, non-competitive levels.
- x. a "party" refers to a participant in the procurement process or contract execution.

**SECTION 13**  
**PRE BID MEEING**

## PREBID MEETING

Pre-bid meeting of the interested parties shall be convened at the designated date, time and place. A maximum of three representatives of each Applicant shall be allowed to participate on production of authority letter from the Applicant.

During the course of Pre-bid meeting, the Applicants will be free to seek clarifications and make suggestions for consideration of the Authority. The Authority shall Endeavour to provide clarifications and such further information as it may, in its sole discretion, consider appropriate for facilitating a fair, transparent and competitive Bidding Process.

Any queries or request for additional information concerning this TENDER shall be submitted by e-mail to [eemechsws.so@mctgm.gov.in](mailto:eemechsws.so@mctgm.gov.in) The subject shall clearly bear the following identification/ title: "Queries/ Request for Additional Information: TENDER for (Tender Subject) Any changes in mail ID will be intimated on the portal.

The queries shall be submitted in following proforma.

<b>Sr. No.</b>	<b>Tenders section/ Clause reference</b>	<b>Provision in Tender clause</b>	<b>Query/ Clarification requested</b>
1			
2			
...			

**SECTION 14**  
**LIST OF APPROVED BANKS**

## LIST OF APPROVED BANKS

1. The following Banks with their branches in Greater Mumbai and in suburbs and extended suburbs up to Virar and Kalyan have been approved only for the purpose of accepting Banker's guarantee from 1997-98 onwards until further instructions.
2. The Bankers Guarantee issued by branches of approved Banks beyond Kalyan and Virar can be accepted only if the said Banker's Guarantee is countersigned by the Manager of a branch of the same Bank, within the Mumbai Limit categorically endorsing thereon that said Banker's Guarantee is binding on the endorsing Branch of the bank within Mumbai limits and is liable to be enforced against the said branch of the Bank in case of default by the contractor/supplier furnishing the Banker's Guarantee.
3. **List of approved Banks:-**

A	S.B.I and its subsidiary Banks
1	State Bank Of India.
2	<del>State Bank Of Bikaner &amp; Jaipur.</del>
3	State Bank Of Hyderabad.
4	State Bank Of Mysore.
5	State Bank Of Patiyala.
6	State Bank Of Saurashtra.
7	State Bank Of Travankore.
B	Nationalized Banks
8	Allahabad Bank.
9	Andhra Bank.
10	Bank Of Baroda.
11	Bank Of India.
12	Bank Of Maharashtra.
13	Central Bank Of India.
14	Dena Bank.
15	Indian Bank.
16	Indian Overseas Bank.
17	Oriental Bank Of Commerce.
18	Punjab National Bank.

19	Punjab & Sindh Bank.
20	Syndicate Bank.
21	Union Bank Of India.
22	United Bank Of India.
23	UCO Bank.
24	Vijaya Bank.
24A	Corporation Bank.
C	Scheduled Commercial Banks
25	Bank Of Madura Ltd.
26	Bank Of Rajasthan Ltd.
27	Banaras State Bank Ltd.
28	Bharat Overseas Bank Ltd
29	Catholic Syrian Bank Ltd.
30	City Union Bank Ltd.
31	Development Credit Bank.
32	Dhanalakshmi Bank Ltd.
33	Federal Bank Ltd.
34	Indsind Bank Ltd.
35	I.C.I.C.I Banking Corporation Ltd.
36	Global Trust Bank Ltd.
37	Jammu & Kashmir Bank Ltd.
38	Karnataka Bank Ltd.
39	KarurVysya Bank Ltd.
40	Laxmi Vilas Bank Ltd.
41	Nedugundi Bank Ltd.
42	Ratnakar Bank Ltd.
43	Sangli Bank Ltd.
44	South Indian Bank Ltd.
45	S.B.I Corporation &Int Bank Ltd.
46	Tamilnadu Mercantile Bank Ltd.
47	United Western Bank Ltd.
48	Vysya Bank Ltd.
D	Schedule Urban Co-op Banks
49	Abhyudaya Co-op Bank Ltd.
50	Bassein Catholic Co-op Bank Ltd.
51	Bharat Co-op Bank Ltd.
52	Bombay Mercantile Co-op Bank Ltd.
53	Cosmos Co-op Bank Ltd.
54	Greater Mumbai Co-op Bank Ltd.
55	JanataSahakari Bank Ltd.

56	Mumbai District Central Co-op Bank Ltd.
57	Maharashtra State Co-op Bank Ltd.
58	New India Co-op Bank Ltd.
59	North Canara G.S.B. Co-op Bank Ltd.
60	Rupee Co-op Bank Ltd.
61	Sangli Urban Co-op Bank Ltd.
62	Saraswat Co-op Bank Ltd.
63	ShamraoVithal Co-op Bank Ltd.
64	Mahanagar Co-op Bank Ltd.
65	Citizen Bank Ltd.
66	Yes Bank Ltd.
E	Foreign Banks
67	ABM AMRO (N.Y.) Bank.
68	American Express Bank Ltd.
69	ANZ Grindlays Bank Ltd.
70	Bank Of America N.T. & S.A.
71	Bank Of Tokyo Ltd.
72	Bankindosuez.
73	BanqueNationale de Paris.
74	Barclays bank.
75	City Bank N.A.
76	Hongkong& Shanghai banking Corporation.
77	Mitsui Taiyokbe Bank Ltd.
78	Standard Chartered Bank.
79	Cho Hung Bank.

- 4. For more details, Refer Circular under no. CA/FBK/39 dated 07.12.2012, CA/FBK/25 dated 30.10.2014 & CA/FBK/241 dated 27.11.2019 regarding list of approved banks for acceptance of Bankers Guarantee annexed in the tender document.**



**SECTION 15**  
**APPENDIX AND PROFORMA**

## FORM OF TENDER

To,  
The Municipal Commissioner for Greater Mumbai

Sir,

I/ We have read and examined the following documents relating to the work/of

---

---

- i. Notice inviting tender.
- ii. Directions to tenderers (General and special)
- iii. General condition of contract for Civil Works of the Brihanmumbai Municipal Corporation as amended up to date.
- iv. Relevant drawings.
- v. Specifications.
- vi. Special directions
- vii. A to H
- viii. Bill of Quantities and Rates.

1A. I/We \_\_\_\_\_ (full name in capital letters, starting with surname), the Proprietor/ Managing Partner / Managing Director / Holder of the Business, for the establishment / firm / registered company, named herein below, do hereby offer to .....  
.....referred to in the specifications and schedule to the accompanying form of contract of the rates entered in the schedule of rates sent herewith and signed by me/us. (Strike out the portions which are not applicable).

1B. I/We do hereby state and declare that I/We, whose names are given hereinbelow in details with the addresses, have not filled in this tender under any other name or under the name of any other establishment /firm or otherwise, nor are we in any way related or concerned with the establishment/firm or any other person, who have filled in the tender for the aforesaid work.

2. I/We hereby tender for the execution of the works referred to in the aforesaid documents, upon the terms and conditions, contained or referred to therein and in accordance with the specifications designs, drawings and other relevant details in all respects.

\* At the rates entered in the aforesaid Bill of Quantities and Rates.

3. According to your requirements for payment of Earnest Money amounting to Rs. \_\_\_\_\_ /-(Rs. \_\_\_\_\_ )

I/We have deposited the amount through online payment gateways with the C.E. of the Corporation not to bear interest

4. I/We hereby request you not to enter into a contract with any other person/s for the execution of the works until notice of non/acceptance of this tender has first been communicated to me/us, and in consideration of yours agreeing to refrain from so doing I/we agree not to withdraw the offer constituted by this tender before the date of communication to me/us of such notice of non/acceptance, which date shall be not later than ten days from the date of the decision of the Standing Committee or Education Committee of the Corporation, as maybe required under the Mumbai Municipal Corporation Act, not to accept this tender.(Subject to condition 5 below).
5. I/We also agree to keep this tender open for acceptance for a period of 180 days from the date fixed for opening the same and not to make any modifications in its terms and conditions which are not acceptable to the Corporation.
6. I/We agree that the Corporation shall, without prejudice to any other right or remedy, be at liberty to forfeit the said earnest money absolutely, if.
- a. I/We fail to keep the tender open as aforesaid.
  - b. I/We fail to execute the formal contract or make the contract deposit when called upon to do so.
  - c. I/we do not commence the work on or before the date specified by the Engineer in his work order.
7. I/We hereby further agree to pay all the charges of whatsoever nature in connection with the preparation, stamping and execution of the said contract.
8. I/We further agree that, I/we shall register ourselves as 'Employer' with the Bombay Iron and Steel Labour Board' and fulfill all the obligatory provisions of Maharashtra Mathadi, Hamal and other Manual workers (Regulation of Employment and Welfare) Act 1969 and the Bombay Iron and Steel unprotected workers Scheme 1970.
9. "I/We..... have failed in the accompanying tender with full knowledge of liabilities and, therefore, we will not raise any objection or dispute in any manner relating to any action, including forfeiture of deposit and blacklisting, for giving any information, which is found to be incorrect and against the instructions and directions given in this tender.

10. "I/We further agree and undertake that in the event it is revealed subsequently after the allotment of work/contract to me/us, that any information given by me/us in this tender is false or incorrect, I/We shall compensate the Brihanmumbai Municipal Corporation for any such losses or inconvenience caused to the Corporation in any manner and will not resist any claim for such compensation on any ground whatsoever. I/we agree and undertake that I/we shall not claim in such case any amount by way of damages or compensation for cancellation of the contract given to me/us or any work assigned to me/us or is withdrawn by the Corporation,"

Address

Yours faithfully,

.....  
.....  
.....

Digital Signature of the Tenderer or the Firm

1.....  
2.....  
3.....  
4.....  
5.....

Full Name and private residential address of all the partners constituting the Firm

1. ....  
2. ....  
3. ....  
4. ....  
5. ....

A/c No. ....

Name of Bank .....

Name of Branch .....

Vender No. ....

## AGREEMENT FORM

Tender / Quotation                      dated ..... 20...

Standing Committee/Education Committee Resolution No. ....

CONTRACT FOR THE WORKS.....

This agreement made this day of.....Two thousand.....Between.....

inhabitants of Mumbai, carrying on business at.....

.....in Bombay under the style and

name of Messrs.....

(Hereinafter called "the contractor of the one part and Shri .....

..... the Dy. Municipal Commissioner (hereinafter called "the commissioner" in which

expression are included unless the inclusion is inconsistent with the context, or meaning thereof,

his successor or successors for the time being holding the office of Dy. Municipal Commissioner of

the second part and the Brihanmumbai Municipal Corporation (hereinafter called "the

Corporation") of the third part, WHEREAS the contractor has tendered for the construction,

completion and maintenance of the works described above and his tender has been accepted by

the Commissioner (with the approval of the Standing Committee/Education Committee of the

Corporation.

NOW THIS AGREEMENT WITNESSETH as follows:-

1) In this agreement words and expressions shall have the same meanings as are respectively assigned to them in the General Conditions of Contract for works hereinafter referred to:-

2) The following documents shall be deemed to form and be read and constructed as a part of this agreement viz.

- a) The letter of Acceptance
- b) The Bid:
- c) Addendum to Bid; if any
- d) Tender Document
- e) The Bill of Quantities:
- f) The Specification:
- g) Detailed Engineering Drawings
- h) Standard General Conditions of Contracts (GCC)
- i) All correspondence documents between bidder and BMC

3) In consideration of the payments to be made by the Commissioner to the contractor as hereinafter mentioned the contractor hereby covenants with the Commissioner to construct, complete and maintain the works in conformity in all respects with the provision of the contract.

4) The Commissioner hereby covenants to pay to the Contractor in consideration of the construction, completion and maintenance of the works the contract sum, at times and in the manner prescribed by the contract.

IN WITNESS WHERE OF the parties hereto have caused their respective common seals to be herein to affixed (or have hereunto set their respective hands and seals) the day and year above written.

Signed, Sealed and delivered by the contractors

.....  
.....  
.....  
.....

In the presence of

.....  
.....

Trading under the name and style of Contractors

Full Name & Address.....  
.....

Dy.Ch.E. (S.O.) WS Ch.E. (S.O.)

Signed by the Dy. Municipal Commissioner

in the presence of .....

.....  
.....

Deputy Municipal Commissioner

The Common seal of the Brihanmumbai Municipal Corporation was hereunto affixed on the .....20in the presence of two members of the Standing Committee.

- 1. 1.
- 2. 2.

And in the presence of the Municipal Secretary

Municipal Secretary

## ANNEXURE - A

Name of work / supply : Rehabilitation of Malad WWTF - Treatment of Sewage Water by Bioremediation Technology.

The Engineer for this work :

Chief Engineer	.....	Chief Engineer (Sewerage Operations)
Dy.Ch. Engineer	.....	Deputy Chief Engineer (Sewerage Operation) Western Suburb
Executive Engineer	.....	Executive Engineer (Sewerage Operation) Western Suburb

1. Earnest Money:

2. Time Period :

1.	Contract as a whole Period completion	
2.	Part or Groups of items	
	i)	i)
	ii)	ii)
	iii)	iii)

3. Percentage to be charged as supervision charges for the work got executed through other means .....percent.

The "Actual cost of the work" shall mean in the case of percentage rate contracts the actual cost of the work executed at the rates as mentioned in the Contract Schedule adjusted by the Contractor's percentage rate and cost of extra and excess, but excluding the cost on account of Water Charges and Sewerage Charges if any, payable by the contractor and also excluding cost on account of price variation claims as provided in price variation clause as amended up to date.

4. In case of item rate contracts the actual cost calculated for the work executed at the rates mentioned in the contract schedule for different items including cost of excess and extra items of the work excluding the cost of water charges and sewerage charges if any, payable by the contractor and excluding cost on account of price variation claims as provided in extra excess conditions as amended up to date.
  
5. In case of lump sum contract the cost of the work actually carried out as per break up and programme of the work and the schedule of payment included in the contract including cost of any excess and/or extra items, of the work, excluding the cost on account of water charges and sewerage charges and also excluding cost on account of price variation claims as provided in extra excess conditions as amended up to date.



## **Annexure – B**

### **PRE-CONTRACT INTEGRITY PACT**

(On Rs. 500/- Stamp Paper)

Tender ID. \_\_\_\_\_ dated ..... 20...

The Bidder commits himself to take all measures necessary to prevent corrupt practices, unfair means and illegal activities during any stage of his bid or during any pre-contract or post-contract stage in order to secure the contract or in furtherance to secure it and in particular commits himself to the following :-

1. The Bidder will not offer, directly or through intermediaries, any bribe, gift, consideration, reward, favour, any material or immaterial benefit or other advantage, commission, fees, brokerage or inducement to any official of the Brihanmumbai Municipal Corporation, connected directly or indirectly with the bidding process, or to any person, organization or third party related to the contract in exchange for any advantage in the bidding, evaluation, contracting and implementation of the Contract.
2. The Bidder further undertakes that he has not given, offered or promised to give, directly or indirectly any bribe, gift, consideration, reward, favour, any material or immaterial benefit or other advantage, commission, fees, brokerage or inducement to any official of the Brihanmumbai Municipal Corporation or otherwise in procuring the Contract or forbearing to do or having done any act in relation to the obtaining or execution of the Contract or any other Contract with the Government for showing or forbearing to show favour or disfavour to any person in relation to the Contract or any other Contract with the Government.
3. The Bidder will not collude with other parties interested in the contract to impair the transparency, fairness and progress of the bidding process, bid evaluation, contracting and implementation of the contract.
4. The Bidder will not accept any advantage in exchange for any corrupt practice, unfair means and illegal activities.

5. The Bidder, either while presenting the bid or during pre-contract negotiations or before signing the contract, shall disclose any payments he has made, is committed to or intends to make to officials of the Brihanmumbai Municipal Corporation or their family members, agents, brokers or any other intermediaries in connection with the contract and the details of services agreed upon for such payments.
6. The Bidder shall not use improperly, for purposes of competition or personal gain, or pass on to others, any information provided by the Brihanmumbai Municipal Corporation as part of the business relationship, regarding plans, technical proposals and business details, including information contained in any electronic data carrier. The Bidder also undertakes to exercise due and adequate care lest any such information is divulged.
7. The Bidder commits to refrain from giving any complaint directly or through any other manner without supporting it with full and verifiable facts.
8. The Bidder shall not instigate or cause to instigate any third person to commit any of the actions mentioned above.
9. The Bidder and their respective officers, employees, agents and advisers shall observe the highest standard of ethics during the Bidding Process. Notwithstanding anything to the contrary contained herein, the Authority may reject an Application without being liable in any manner whatsoever to the Applicant if it determines that the Applicant has, directly or indirectly or through an agent, engaged in corrupt practice, fraudulent practice, coercive practice, undesirable practice or restrictive practice in the Bidding Process

For the purposes of this Clause 9, the following terms shall have the meaning herein after respectively assigned to them:

- i. "fraudulent practice" means a misrepresentation or omission of facts or suppression of facts or disclosure of incomplete facts, in order to influence the Bidding Process ;

- ii. “coercive practice” means impairing or harming or threatening to impair or harm, directly or indirectly, any person or property to influence any persons participation or action in the Bidding Process;
- iii. “undesirable practice” means (i) establishing contact with any person connected with or employed or engaged by the Authority with the objective of canvassing, lobbying or in any manner influencing or attempting to influence the Bidding Process; or (ii) having a Conflict of Interest; and
- iv. “restrictive practice” means forming a cartel or arriving at any understanding or arrangement among Applicants with the objective of restricting or manipulating a full and fair competition in the Bidding Process.

**Signature of Tenderer/Bidder**

**Annexure – C**  
**DECLARATION CUM INDEMNITY BOND**

(On Rs. 500/- Stamp Paper)

Tender ID. \_\_\_\_\_ dated ..... 20...

I, \_\_\_\_\_ of \_\_\_\_\_, do hereby declare and undertake as under.

1. I declare that I have submitted certificates as required to Executive engineer (Monitoring) at the time of registration of my firm/company \_\_\_\_\_ and there is no change in the contents of the certificates that are submitted at the time of registration.
2. I declare that I \_\_\_\_\_ in capacity as Manager/Director/Partners/Proprietors of \_\_\_\_\_ has not been charged with any prohibitory and /or penal action such as banning (for specific time or permanent) / de-registration or any other action under the law by any Government and/or Semi Government and/or Government undertaking.
3. I declare that I have perused and examined the tender document including addendum, condition of contract, specifications, drawings, bill of quantity etc. forming part of tender and accordingly, I submit my offer to execute the work as per tender documents at the rates quoted by me in capacity as \_\_\_\_\_ of \_\_\_\_\_.
4. I further declare that if I am allotted the work and I failed to carry out the allotted work in accordance with the terms and conditions and within the time prescribed and specified, Brihanmumbai Municipal Corporation is entitled to carry out the work allotted to me by any other means at my risk and cost, at any stage of the contract.
5. I also declare that I will not claim any charge/damages/compensation for non availability of site for the contract work at any time.
6. I declare that I will positively make the arrangements of the required equipment on the day of commencement or with respect to the progress of the work in phases, as per the instructions of site in charge.

**Signature of Tenderer/Bidder**

## **BANKERS GURANTEE IN LIEU OF CONTRACT DEPOSIT**

THIS INDENTURE made this \_\_\_\_\_ day of \_\_\_\_\_ BETWEEN THE \_\_\_\_\_ BANK incorporated under the English/Indian Companies Acts and carrying on business in Mumbai (hereinafter referred to as 'the bank' which expression shall be deemed to include its successors and assigns) of the first part \_\_\_\_\_ inhabitants carrying on business at \_\_\_\_\_ in Mumbai under the style and name of Messer's \_\_\_\_\_ (hereinafter referred to as 'the consultant') of the second part Shri. \_\_\_\_\_ THE MUNICIPAL COMMISSIONER FOR GREATER MUMBAI (hereinafter referred to as 'the commissioner' which expression shall be deemed, also to include his successor or successors for the time being in the said office of Municipal Commissioner ) of the third part and THE BRIHANMUMBAI MUNICIPAL CORPORATION (hereinafter referred to as 'the Corporation') of the fourth part WHEREAS the consultants have submitted to the Commissioner tender for the execution of the work of " \_\_\_\_\_ " and the terms of such tender /contract require that the consultants shall deposit with the Commissioner as/contract deposit/ earnest money and /or the security a sum of Rs. \_\_\_\_\_ (Rupees \_\_\_\_\_)

AND WHEREAS if and when any such tender is accepted by the Commissioner, the contract to be entered into in furtherance thereof by the consultants will provide that such deposit shall remain with and be appropriated by the Commissioner towards the Security deposit to be taken under the contract and be redeemable by the consultants, if they shall duly and faithfully carry out the terms and provisions of such contract and shall duly satisfy all claims properly chargeable against them there under AND WHEREAS the consultants are constituents of the Bank and in order to facilitate the keeping of the accounts of the consultants, the Bank with the consent and concurrence of the consultants has requested the Commissioner to accept the undertaking of the Bank hereinafter contained, in place of the contractors depositing with the Commissioner the said sum as earnest money and /or security as aforesaid AND WHEREAS accordingly the Commissioner has agreed to accept such undertaking NOW THIS AGREEMENT WITNESSES that in consideration of the premises, the Bank at the request of the consultants (hereby

testified) UNDERTAKES WITH the commissioner to pay to the commissioner upon demand in writing , whenever required by him , from time to time , so to do , a sum not exceeding in the whole Rs. \_\_\_\_\_ (Rupees \_\_\_\_\_) under the terms of the said tender and /or the contract .The B.G. Is valid up to \_\_\_\_\_” Notwithstanding anything what has been stated above, our liability under the above guarantee is restricted to Rs. \_\_\_\_\_ only and guarantee shall remain in force up to \_\_\_\_\_ unless the demand or claim under this guarantee is made on us in writing on or before \_\_\_\_\_ all your right under the above guarantee shall be forfeited and we shall be released from all liabilities under the guarantee thereafter”

IN WITNESS WHEREOF

WITNESS (1) Name and address	..... .....	
WITNESS (2) Name and address	..... .....	the duly constituted Attorney Manager
the Bank and the said Messer’s ..... ..... (Name of the Bank)		
WITNESS (1) Name and address	..... .....	
WITNESS (2) Name and address	..... .....	
For Messer’s Address	..... .....	

have hereinto set their respective hands the day and year first above written.

**The amount shall be inserted by the Guarantor, representing the Contract Deposit in  
Indian Rupees.**

**Annexure – D**  
**Rate Analysis**

Tender ID. \_\_\_\_\_ dated ..... 20...

Item Description: .....

Sr. No.	Description of rate analysis Parameters	Unit	Quantity	Rate	Amount
1	Basic Material (Rate should be inclusive of all taxes)				
2	Machinery Hire Charges				
3	Labour Type		(labour components)		
4	Total of all components				
5	Overhead & Profit 15% on 4				
6	Total Rate (4+5)				
7	Per unit rate				

**Sign & Seal of the Tenderer**

## Annexure – E

### Undertaking for best price

( As per circular u/no. DMC/CPD/OD/15 Dtd. 06.05.2013, to be uploaded in folder 'A')

(On stamp paper of Rs. 500/- duly notarized by notary with red seal and registration number)

Tender ID. \_\_\_\_\_ dated ..... 20...

To,

The Municipal Commissioner

For the Brihanmumbai Municipal Corporation

**Sir ,**

"I / We ..... ( Full Name in capital letters starting with surname ), the Proprietor / Managing Partner / Managing Director / Holder of the Business / Manufacturer / Authorized Dealer, for the establishment / firm / registered company , named herein below , do hereby , state and declare that I/We ----- whose names are given herein below in details with the addresses have not filled in this tender under any other name or under the name of any other establishment / firm or otherwise , nor are We in any way related or concerned with any establishment / firm or any other person , who have filled in the tender for the aforesaid work."

" I / We do hereby further undertake that, we have offered the best prices for the subject supply / work as per the present market rates. **Further, we do hereby undertake and commit that we have not offered / supplied the subject product / similar product / system or sub system in the past one year in the Maharashtra State for quantity variation upto– 50% or + 10 % at a price lower than that offered in the present tender to any other outside agencies including Govt. / Semi Govt. agencies and within the Brihanmumbai Municipal Corporation also.** Further, we have filled in the accompanying tender with full knowledge of the above liabilities and therefore we will not raise any objection or dispute in any manner relating to any action, including forfeiture of deposit and blacklisting, for giving any information which is found to be incorrect and against the instructions and directions given in this behalf in this tender.



I / We further agree and undertake that in the event it is revealed subsequently after the allotment of work / contract to me / us , that any information given by me / us in this tender is false or incorrect , I / We shall compensate the Brihanmumbai Municipal Corporation for any such losses or inconvenience caused to the Corporation in any manner and will not resist any claim for such compensation on any ground whatsoever , I / We agree and undertake that I / We shall not claim in such case any amount , by way of damages or compensation for cancellation of the contract given to me / us or any work assigned to me / us or is withdrawn by the Corporation.”

However , in case of price difference, if it is a result of differential tax structures, different dollar value of Rupee, differential logistic of transport etc. Considering this aspect, before invoking the penalty, black-listing, I/We will be given a reasonable opportunity of being heard by representing our case as to why such price variation / differential has been arisen.

In case if the explanation submitted by me / us is unsatisfactory then action including forfeiture of despite and black-listing may be taken against me/us.

**Tenderer’s full Signature with full name  
&address with rubber stamp**

**Annexure – F**

**INFORMATION REGARDING STATUS OF BIDDER**

(1) (a) Whether it is a proprietor concern \_\_\_\_\_

(b) If so, name of the owner \_\_\_\_\_

(2) If it is a partnership concern, please furnish name of each partner and copy of registration certificate \_\_\_\_\_  
-----

(3) In case of company, please furnish the documentary proof to show that the company is registered. \_\_\_\_\_  
-----

(4) In case of Joint Venture, please furnish the name of each firm and Joint Venture forms. \_\_\_\_\_  
-----

**Signature of authorized**

**Person of concern/company**

**Name of concern/company and seal**

**Annexure-G**

**MANUFACTURERS AUTHORISATION CERTIFICATE**

(To be submitted on Letter head of Manufacturer in Packet 'B' as per Bidding Schedule)

This is to certify that M/s..... are Authorized Representative of  
..... since..... till date for dealing in.....  
.....

We authorize them to quote for the tender .....  
..... bearing  
no..... to be submitted on..... and also promise to provide  
uninterrupted supply of \_\_\_\_\_ for the said project as per  
the schedule of the work and to provide all necessary technical support during the entire  
contract period.

Place :

Date :

Seal of the Manufacturer & Sign of  
Authority signatory

## **Annexure 'H'**

### **Irrevocable Undertaking**

**(onRs. 500/- Stamp Paper )**

I Shri/Smt. aged, ..... years Indian Inhabitant.....  
Proprietor/ Partner/Director of M/s resident at .....  
do hereby give Irrevocable undertaking as under;

1. I say & undertake that as specified in section 171 of CGST Act, 2017, any reduction in rate of tax on supply of goods or services or the benefit of input tax credit shall be mandatorily passed on to BMC by way of commensurate reduction in prices.
2. I further say and undertake that I understand that in case the same is not passed on and is discovered at any later stage, BMC shall be at liberty to initiate legal action against me for its recovery including, but not limited to, an appeal to the Screening Committee of the GST Counsel.
3. I say that above said irrevocable undertaking is binding upon me/my partners/company/other Directors of the company and also upon my/our legal heirs, assignee, Executor, administrator etc.
4. If I fail to compliance with the provisions of the GST Act, I shall be liable to penalty/ punishment or both as per the provision of GST Act.

Whatever has been stated here in above is true & current to my/our own knowledge & belief.

**Solemnly affirmed at DEONANT**

**This day of BEFORE ME**

**Interpreted Explained and identified by me**

## **Annexure– I**

### **BRIHANMUMBAI MUNICIPAL CORPORATION**

#### **CIRCULAR U/No. MGC/F/6342 dated 5.5.2018**

**Sub.:** Revised guidelines regarding barricades being used during the execution of various infrastructure development projects by Brihanmumbai Municipal Corporation in Mumbai.

Various infrastructure development projects are being executed by Brihanmumbai Municipal Corporation for the betterment of citizens of Mumbai. During the course of execution of the projects, it is necessary to provide strong and secured barricading as a safety measure to avoid any mishaps as well as to avoid nuisance to vehicular and pedestrian traffic. Nowadays, the following types of barricades are being used exclusively in Brihanmumbai Municipal Corporation as per the convenience of various departments at different sites.

1. Water/s and tillable PVC Metro barricades.
2. RW7.45 (G.I. sheets of 22 gauge fixed on 3 inch dia. Wooden bullies buried in existing road sufficiently)
3. RW7.36 (G.I. sheets of 22 gauge fixed on MS Angle post buried in half the depth in drums of 20 litres capacity in 1:3:6 concrete).
4. Structural steel barricade for major trenches having depth more than 2.00 meters.

Thus from the above, it can be seen that there is no uniformity in provision of barricades as they are of different size and shape. Further it is also observed that the continuity is not maintained in providing the barricading keeping gaps in between thus endangering the safety of vehicular as well as pedestrian traffic. Also the barricades are not being cleaned, thus further adding to shabbiness. Further Mumbai being the financial capital of India, people from all over the world visit the city daily and to maintain good image of city the following decisions are taken.

- A) Only two type of barricades having department wise colour coding are proposed to be used depending upon the nature of work i.e. Minor and Major.
- (i) **Minor works:** Barricading made out of 1.5 mm thick MS plate fixed on M.S. angle post, V frame of 65 mm X 65 mm X 6 mm having height of 1.5m supported on as shown in Annex-1.
  - (ii) **Major works:** Structural steel barricade made out of 1.50 mm thick M. S. Plate ISMB 250, 1 SLC 250 X 50 mm and ISA 50mmX50mmX6mm having of size 2.5mX2m as shown in Annex-11.
- B) The department wise colour coding for the barricading shall be as under:-
- (i) H.E. & W.S.P. department – **Blue**
  - (ii) Roads, Traffic, Bridges and Coastal Roads department- **Yellow**
  - (iii) S.P. & S.O department- **Green**
  - (iv) S.W.D., Building Maintenance department & for ward works – **Red**
- C) The basic principle behind installing secured and continuous barricading is to ensure the safety of vehicular as well as pedestrian traffic and residents in the nearby vicinity of the project. Due to non-installation of appropriate barricades on sites if any mishap occurs leading to injury or loss of life, then the contractor and contractor's Engineer in-charge will be liable for the consequent action.
- D) During the course of execution of project, if it is noticed that the contractor has not provided barricading then a penalty of Rs.1000/- per meter per day will be imposed upon the contractor and will be deducted from the due Bill. This penalty shall be apart of penalty as per tender condition.
- E) Details of the work shall be prominently displayed on the central panel of the barricades along-with the Social Slogans as given in Annexure-III and the Cycle of the same shall be maintained.

F) The contractor shall provide and install the barricading along with the slogans printed as per the Annexure III, at his own cost and no payment will be made for this; however the contractor shall quote the bid accordingly by considering the cost of barricading. The condition shall be included in the tender as given below. "Barricading shall be provided free of cost as per Circular vide U/No.MGC/F/6342 dated 5.5.2018 and as per Annexure I, II and III of Standard drawings and specifications with slogans and department wise colour codes." The copy of circular will be attached to the tender as a part of tender document. This circular will be applicable for the new tenders proposed to be invited from 01.05.2018 and also the corrigendum shall be attached to tenders which are uploaded. However, for the projects wherein the tenders are already invited, the barricading shall be provided strictly as per tender condition. All the details (Annexure I, II & III of Standard drawings and specifications with slogans and department wise colour codes, sketches and department wise colour coding) are uploaded on Brihanmumbai Municipal Corporation portal.

This circular shall come in force with immediate effect.

Sd/- 20.4.2018  
(Shri. V. P. Chithore)  
**Dir.(ES&P)**

sd/-20.4.2018  
(Shri. R. B. Bambale)  
**D.M.C.(S.E.)**

sd/- 21.4.2018  
{Shri. Vijay Singhal)  
**A.M.C.(E.S.)**

sd/- 21.4.2018  
(Dr.Shri. Sanjay Mukherjee)  
**A.M.C.(P.)**

sd/-16.5.2018  
(Shri. P. R. Kadam)  
**D.M.C.(S.E.)**

sd/-16.05.2018  
(AjoyMehta)  
**M.C.**

## ANNEXURE I

### A) Minor Work

Providing, fabricating and installing the barricading made out of 1.5m high M.S. Angle post of 65mm x 65mm x 6mm with 1.5 mm thick M.S. Sheet of size 1.55m x 1.2m welded to the M.S. angle post/frames and fixed to 75mm x 75mm x 6mm angle base as shown in sketch for minor works, displaying of the social slogan as per the Annex-III, daily cleaning of the same to get better appearance and interlocking arrangement to ensure continuity in provision and to avoid gap in between etc complete and as directed by Engineer in-Charge.

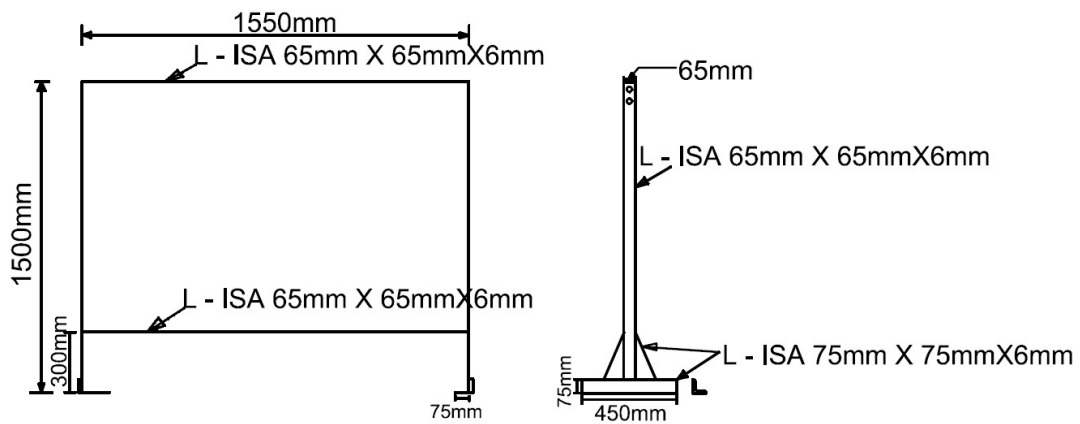



## ANNEXURE II

### B) Major Works:

Providing, fabricating and installing the structural steel barricading made out of 1.5mm thick M.S. plate of size 2500mm x 2000mm, ISMC 250 x 50 Channels, M.S. Angles ISA 50 x 50 x 6mm and ISMB 250 as per IS 1161 – 1 RHS/SHS rolled angle plates of TATA Steel, Lloyd Steel, SAIL, ESSAR steel approved in straight profile of all sizes, shapes and for all works including stiffeners, bolts and nuts, fillet/butt welding, splicing, machine grinding, of all member joints wherever required to give neat appearance and daily cleaning the barricading along with displaying of the Depth wise slogans as given in Annexure – III etc with interlocking arrangement to avoid gap in between and as directed by Engineer-in-Charge.

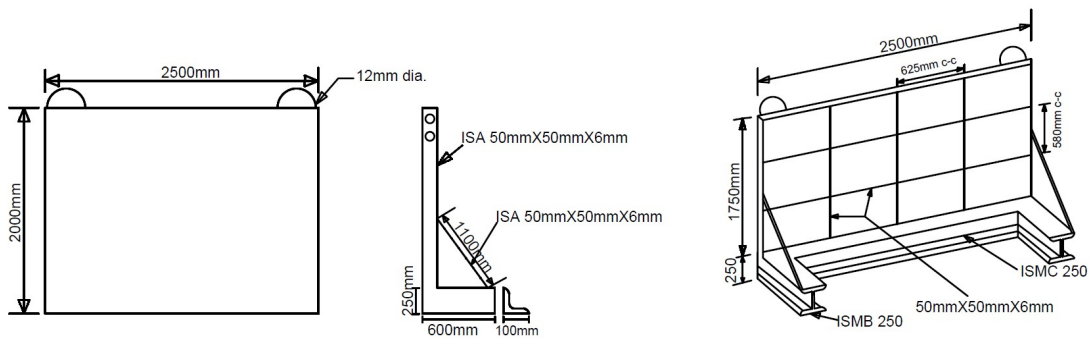

## **ANNEXURE III**

### **1) HYDRAULIC ENGINEERS'S DEPARTMENT /WATER SUPPLY PROJECTS**

- i) Inconvenience Regretted
- ii) Ensuring Mumbai's Water Supply
- iii) Save Water Save Life

### **2) ROAD, TRAFFIC / BRIDGES DEPARTMENT**

- i) Inconvenience Regretted
- ii) Working towards a better tomorrow
- iii) My Mumbai, Green Mumbai

### **3) SEWERAGE PROJECTS DEPARTMENT/ SEWERAGE OPERATIONS DEPARTMENT**

- i) Inconvenience Regretted
- ii) Reduce Reuse Recycle
- iii) Clean Mumbai, Healthy Mumbai

### **4) STORM WATER DRAIN DEPARTMENT /WARD WORKS**

- i) Inconvenience Regretted
- ii) Working towards a better tomorrow
- iii) Swatch Bharat

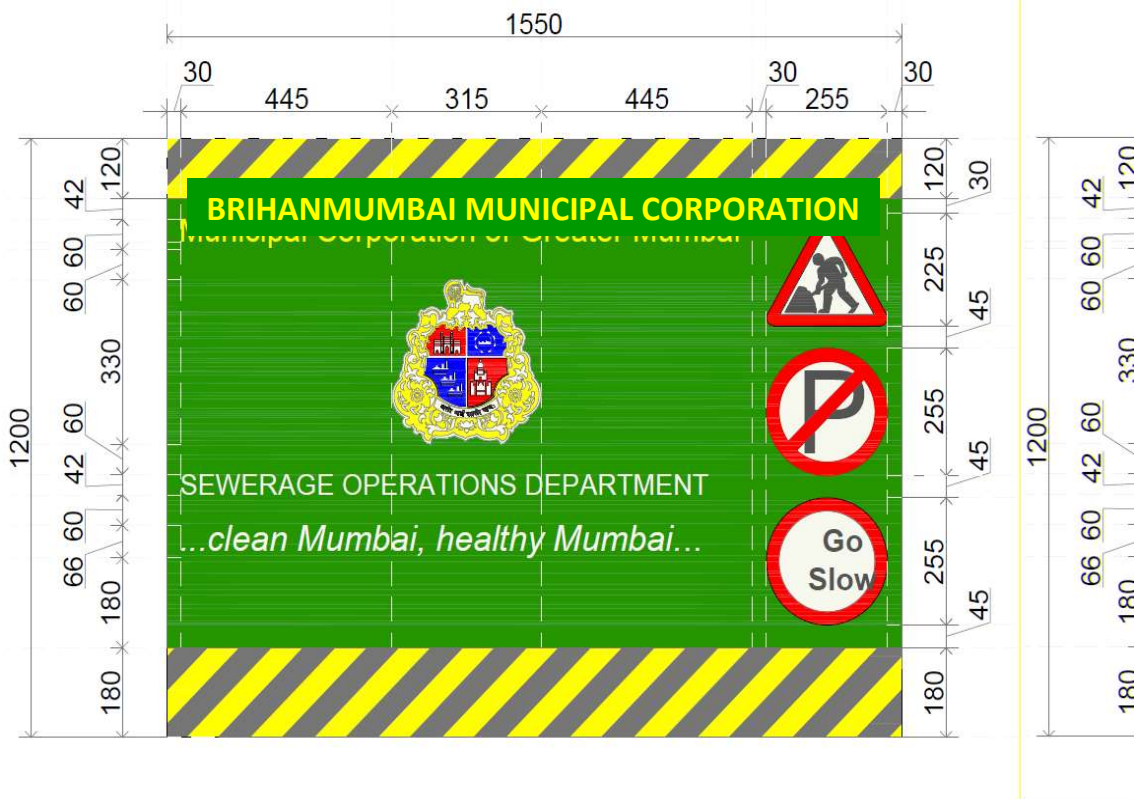

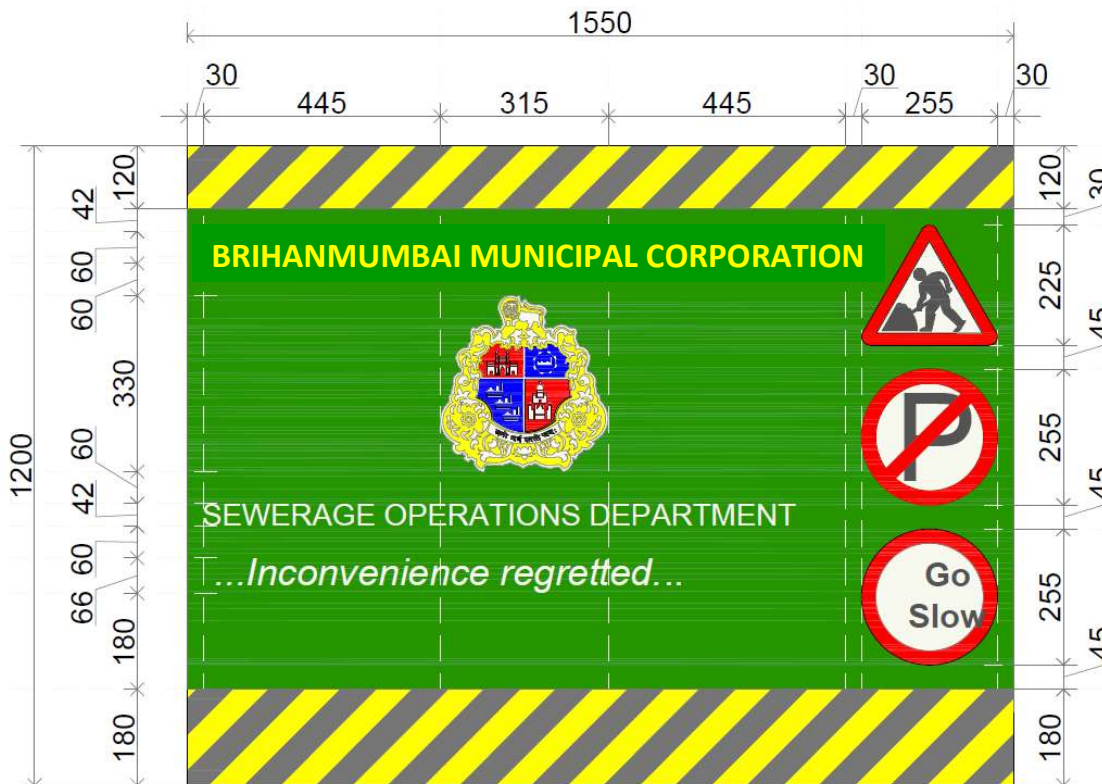





Annexure- J

बृहन्मुंबई महानगरपालिका  
विधी खाते

परिपत्रक क्र. २६२०६ दि. 31.08.2023

- विषय - कंत्राट करार करण्यासाठी वसूल करावयाचे विधी आकार (Legal charges) व लेखनसाहित्य आकार (Stationery charges)
- संदर्भ - 1. परिपत्रक क्र. 10539 दि. 28.03.2023  
2. एमजीसी/एफ/534 दि. 28.08.2023

.....

महानगरपालिकेच्या विविध खात्यांमार्फत मागविण्यात येणा-या निविदांसंदर्भात लेखी करार करताना पक्षकाराकडून एकत्रितरित्या आकारावयाच्या विधी आकार व लेखनसाहित्य आकाराची उपरोक्त संदर्भित क्र. 1 वरील परिपत्रकानुसार दि. 01.04.2023 पासून आकारणी करण्यात आलेली आहे.

तथापि महानगरपालिका आयुक्त यांच्या संदर्भ क्र. 2 च्या मंजूरीनुसार कंत्राट करार करण्यासाठी वसूल करावयाचे विधी आकार (Legal charges) व लेखनसाहित्य आकार (Stationery charges) यामध्ये सुधारणा करण्यात आली असून खालील तक्त्यामध्ये दर्शविल्याप्रमाणे दि.01.09.2023 पासून सुधारीत विधी व लेखनसाहित्य (एकत्रितरित्या) आकार विहित करण्यात आलेले आहेत.

अनु. क्र	कंत्राट किंमत	एकत्रितरित्या आकारावयाचे सुधारीत विधी व लेखन साहित्य आकार दि. 01.09.2023 पासून दि. 31.03.2024 पर्यंत
1	रु.. 50,000/-	निरंक
2	रु. 50,001 ते रु. 1,00,00,000	कंत्राट किंमतीच्या 0.10% दराने (अशी येणारी रक्कम पुढील शंभराच्या पटीत परावर्तित करणे यासापेक्ष) अधिक 18% दराने वस्तू व सेवाकर ( किमान रु. 1000/- अधिक वस्तू व सेवाकर आणि कमात रु. 10000/- अधिक वस्तू व सेवाकर )
3	रु. 1,00,00,001 ते रु. 10,00,00,000/-	रु. 1,00,00,000/- पर्यंतच्या कंत्राट किंमतीसाठी रु.10,000/- अधिक रु. 1,00,00,000/- पेक्षा जास्त रक्कमेवर 0.05% दराने (अशी येणारी रक्कम पुढील शंभराच्या पटीत परावर्तित करणे यासापेक्ष) अधिक 18% दराने वस्तू व सेवाकर

4	रु. 10,00,00,001 ते पुढील कंत्राट किमतीसाठी	रु. 10,00,00,000/- पर्यंतच्या कंत्राट किमतीसाठी रु.55,000/- अधिक रु. 10,00,00,000/- पेक्षा जास्त रक्कमेवर 0.01% दराने (अशी येणारी रक्कम पुढील शंभराच्या पटीत परावर्तित करणे यासापेक्ष) अधिक 18% दराने वस्तु व सेवाकर
---	---	--

*Shobha*  
31/8/23  
( शोभा अजितकुमार )  
उप कायदा अधिकारी  
(हस्तांतरण -2)  
विधि खाते

*Dice*  
31-08-2023  
( संदिप मो. पाटील )  
संयुक्त कायदा अधिकारी (प्र.)  
(शहर दिवाणी न्यायालय)  
विधि खाते

*Sunil*  
31/8/2023  
( सुनील मोनवणे )  
कायदा अधिकारी  
विधि खाते

परिपत्रक क्र. वि. 31.08.2023

प्रत ..... यांना माहितीकरीता व पुढील आवश्यक त्या कार्यवाहीकरीता अग्रेषित.

*Dice*  
31-08-2023  
( संदिप मो. पाटील )  
उप कायदा अधिकारी (आस्थापना)  
विधि खाते



**Annexure– K**

**BRIHANMUMBAI MAHANAGARPALIKA**

**CIRCULAR**  
2020-21

No.CA(F)/Project/ 32 of 26.10.2020

**Sub : Bid Security or EMD**

**Ref : No.MDD/7878 of 27.09.2016**

The MCGM's tender conditions have been amended and Standard Bid Document has been circulated vide No.MDD/7878 of 27.09.2016.

The condition of refund of Bid Security or EMD incorporated in SBD, is as follows :-

- (i) The Bid Security of the successful bidder will be discharged when the bidder has signed the agreement and furnished the required Security Deposits.
- (ii) The Bid Security/EMD of L-3 and bidders shall be refunded immediately after opening of financial bid but **the EMD/ASD submitted by the L-2 bidder will be returned after obtaining Standing Committee Resolution.**

In recent past, due to COVID-19 pandemic, various benefits and relief are given to contractor for ease of doing business and to maintain their cash flow. Further, the Statutory Committee meetings are not held in this pandemic situation. Hence, the condition of refund of Bid Security/EMD and ASD is reviewed and revised condition for all invited tenders wherein Statutory Committee's sanction has not been accorded and forthcoming e-tenders –

- (a) The Bid Security/EMD of the successful bidder will be discharged when the bidder has signed the agreement and furnished the required Security Deposits.
- (b) The Bid Security/EMD and ASD of L-2 and other higher bidders (L-3, L-4, etc.) shall be refunded immediately after opening of financial bid.

(c) In case, the successful bidder becomes non-responsive or successful bidder withdraws the bid or is unwilling to extend the bid validity period, in such circumstances, if L-2 bidder is agreeable to extend the bid validity period and ready to deposit the requisite amount of bid security/EMD and ASD to the department within the stipulated time period i.e. 15 days, the department will process further as per normal procedure.

The above revised directives shall come into effect immediately on issuance of this circular.

All Chief Engineers/Head of Departments/Deans shall note the above directives and follow them scrupulously.

Sd/-13.10.2020  
C.A.(W.S.S.D.)

Sd/-13.10.2020  
C.A.(Finance)i.c

Sd/-13.10.2020  
D.M.C.(Infra)

Sd/-13.10.2020  
D.M.C.(E)

Sd/-13.10.2020  
Dir.(ES&P)

Sd/-16.10.2020  
A.M.C.(P)

Sd/-23.10.2020  
Municipal Commissioner

## Annexure-L

बृहन्मुंबई महानगरपालिका

परिपत्रक

२०२०-२१

क्र.प्रले(वित्त)/४२ दिनांक ०९.०२.२०२१

**विषय:-** बृहन्मुंबई महानगरपालिकेत कंत्राटदारामार्फत पार पाडावयाच्या कामाच्या मसुदा निविदेमध्ये अतिरिक्त सुरक्षा अनामत रक्कमेबाबतची सुधारित अट समाविष्ट करण्याबाबत.

**संदर्भ:-** एमडीडी/७८७८ दिनांक २७.०९.२०१६.

बृहन्मुंबई महानगरपालिकेत कंत्राटदारामार्फत पार पाडण्यात येणाऱ्या कामाकरिताच्या मसुदा-निविदेत समाविष्ट करावयाच्या अतिरिक्त सुरक्षा अनामत रक्कमेबाबतच्या अटीबाबतचे निर्देश संदर्भित परिपत्रकान्वये निर्गमित करण्यात आले आहेत. त्यामध्ये खालीलप्रमाणे सुधारणा करण्यात येत आहे.

**विद्यमान पध्दत:-**

ई-निविदा सूचनेस प्रतिसाद करून ज्या ज्या कंत्राटदारानी वजा -१२% पेक्षा कमी दराने टक्केवारी उदधृत केली आहे, अश्या सर्व कंत्राटदारांना वजा १२% पेक्षा जास्त नमूद केलेल्या प्रत्येक टक्क्याला १% याप्रमाणे कोणतीही मर्यादा न ठेवता ऑनलाईन निविदा सादर करताना अतिरिक्त सुरक्षा अनामत रक्कम ऑनलाईन स्विकारली जाते.

**सुधारित पध्दत:-**

१. कंत्राटदाराने वजा -१२% पेक्षा कमी दराने टक्केवारी उदधृत केली असल्यास वजा १२% पेक्षा जास्त असलेल्या प्रत्येक टक्क्याला १% याप्रमाणे ऑनलाईन निविदा सादर करताना अतिरिक्त सुरक्षा अनामत रक्कमेचा ऑनलाईन भरणा करणे आवश्यक नसेल.

२. कंत्राट रकमेनुसार सक्षम प्राधिकाऱ्यांची मंजूरी प्राप्त झाल्यानंतर प्रथम लघुत्तम असलेल्या निविदाकाराने कार्यस्विकृती पत्रात नमूद केल्यानुसार कार्यालयीन कामकाजाच्या १५ दिवसात विद्यमान पध्दतीनुसार अतिरिक्त सुरक्षा अनामत रक्कम डिमांड ड्राफ्ट स्वरूपात महानगरपालिकेचा नागरी सुविधा केंद्रात जमा करणे व त्या पावतीची प्रत खातेप्रमुखाकडे सादर करणे आवश्यक असेल.

३. जर प्रथम लघुत्तम निविदाकाराने कार्यस्विकृती पत्रात नमूद केल्यानुसार कार्यालयीन कामकाजाच्या १५ दिवसामध्ये अतिरिक्त सुरक्षा अनामत रक्कम जमा केली नाही तर सदर कंपनीने भरणा केलेली संपूर्ण इसारा अनामत रक्कम (EMD) जप्त केली जाईल तसेच कंपनीला दोन वर्षासाठी डीबार (Debar) करण्यात येईल, त्याचप्रमाणे त्या कंपनीचे संचालक/

LoA)

*Cable joining*

पार्टनर इतर कंपनीमध्ये संचालक/ पार्टनर म्हणून कार्यरत असतील तर ती कंपनी सुद्धा दोन वर्षाकरिता डीबार (Debar) करण्याची कार्यवाही करण्यात येईल.

यापुढील कामाकरिताच्या मसुदानिघिदेत परिपत्रकात नमूद केल्याप्रमाणे अतिरिक्त सुरक्षा अनामत रक्कमेबाबतची अट अंतर्भूत करण्यात यावी.

उपरोक्त सूचनांचे काटेकोरपणे अंमलबजावणी करण्याबाबत सर्व खाते प्रमुख/ सहाय्यक आयुक्त/ रुग्णालय अधिष्ठाता/ वैद्यकीय अधीक्षक/ उप प्रमुख लेखापाल/ लेखा अधिकारी यांनी दक्षता घ्यावी.

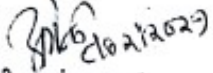
  
(श्री. अनंत कदम)

उपायुक्त - (पायाभूत सुविधा)

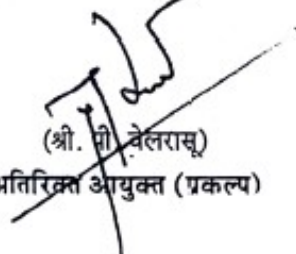
  
(श्री. पी. वेलराव)  
अतिरिक्त आयुक्त (प्रकल्प)

  
(रा. क. आर्षाड)

प्रमुख लेखापाल (वित्त) प्र.

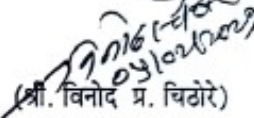
  
(श्री. विनोद प्र. चिटोरे)  
संचालक (अ.से.व.प्र)

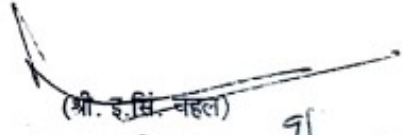
  
(श्री. इ.मि. चहल)  
महानगरपालिका आयुक्त 7/221-

## Annexure-M

जन.२८६-२५००(२)

### बृहन्मुंबई महानगरपालिका

#### परिपत्रक

२०१२-१३

क्रमांक :- सीए/एफबीके/३९, दिनांक ०७/१२/२०१२

विषय :- बँकेने दिलेले हमीपत्र (बँकर्स गॅरंटी) स्वीकारण्याबाबत.

कंत्राटदार/पुरवठादार यांच्याकडून सादर करण्यात येणारी बँक हमीपत्रे (बँकर्स गॅरंटी) स्वीकारण्यासंदर्भात एक प्रशासकीय धोरणात्मक बाब म्हणून (१) स्टेट बँक ऑफ इंडिया आणि तिच्या संलग्न बँका, (२) राष्ट्रीयीकृत बँका, (३) अनुसूचित वाणिज्य बँका, (४) अनुसूचित नागरी सहकारी बँका, (५) विदेशी बँका ह्या प्रवर्गातील बृहन्मुंबई महानगरपालिका तसेच त्यापुढील विरार व कल्याण पर्यंतच्या क्षेत्रातील विहित बँका आणि त्यांच्या शाखा यांनी दिलेली बँक हमीपत्रे स्वीकारण्यास मान्यता देण्यात आलेली असून, यासंदर्भातील सूचना सर्व संबंधितांच्या माहितीकरीता वेळोवेळी परिक्रमित करण्यात आल्या आहेत. त्या सातत्यात पुढील प्रमाणे नमूद करण्यात येत आहे :-

■ रिझर्व बँक ऑफ इंडिया यांनी त्यांच्या 'rbidocs.rbi.org.in/rdocs/publications/pdfs/84656.pdf' ह्या अधिकृत वेबसाईटवर रिझर्व बँक ऑफ इंडिया अधिनियम, १९३४ अन्वयेची अनुसूची-दोन माहितीकरीता उपलब्ध केलेली आहे. सदर अनुसूची-दोन मध्ये (१) स्टेट बँक ऑफ इंडिया आणि तिच्या संलग्न बँका, (२) राष्ट्रीयीकृत बँका, (३) इतर सार्वजनिक क्षेत्रातील बँका, (४) खाजगी क्षेत्रातील बँका, (५) विदेशी बँका ह्या प्रवर्गात नमूद करण्यात आलेल्या बृहन्मुंबई महानगरपालिका तसेच त्यापुढील विरार व कल्याण पर्यंतच्या क्षेत्रातील सर्व बँकांच्या शाखा, बँक हमीपत्रे स्वीकारण्याबाबतच्या प्रयोजनाकरीता मान्यताप्राप्त आहेत.

■ सदर अनुसूची दोन मधील राज्य सहकारी बँका आणि ग्रामीण बँका ह्या प्रवर्गातील बँका मात्र (महाराष्ट्र स्टेट को.ऑप.बँक लि, मुंबई ही एक बँक वगळता) बँक हमीपत्रे स्वीकारण्याबाबतच्या प्रयोजनाकरीता मान्यताप्राप्त नाहीत.

■ महाराष्ट्र सहकारी संस्था अधिनियम, १९६०च्या तरतूदी विचारात घेऊन "महाराष्ट्र स्टेट को.ऑप.बँक" आणि "मुंबई डिस्ट्रिक्ट सेंट्रल को.ऑप.बँक" ह्या दोन सहकारी बँका, बँक हमीपत्रे स्वीकारण्याच्या प्रयोजनाकरिता मान्यताप्राप्त आहेत असे यापूर्वी ठरविण्यात आले आहे. त्यानुसार सदर दोन्ही बँका प्रस्तुत प्रयोजनाकरिता यापुढेही मान्यताप्राप्त आहेत असे समजण्यात यावे.

E/VIKAS/BANK GUARANTY 2012

जन-२८६

2

■ बँक हमीपत्रे स्वीकारण्याबाबतच्या प्रयोजनाकरीता मान्यताप्राप्त असलेल्या उपरोल्लेखित बँकांच्या कल्याण आणि विरार या शहरांच्या पुढील क्षेत्रातील शाखेने दिलेले बँक हमीपत्र सादर करण्याची कंत्राटदारांची/पुरवठादारांची इच्छा असल्यास, सादर बँक हमीपत्रावर त्याच बँकेच्या मुंबई शहराच्या हद्दीमधील शाखेच्या व्यवस्थापकांनी, हे बँक हमीपत्र आपल्या शाखेवर बंधनकारक राहिल आणि ते देणा-या कंत्राटदाराने/पुरवठादाराने कोणताही कसूर केल्यास सादर हमीपत्राच्या अंमलबजावणीच्या कारवाईसाठी आपली शाखा पात्र राहिल असे बिनशर्त प्रतिसाक्षात्करण देणे अनिवार्य आहे.

■ बँक हमीपत्रासंदर्भात संबंधित बँकेकडून करण्यात येणाऱ्या कोणत्याही पत्रव्यवहारात कंत्राटदाराचे नांव, कंत्राट क्रमांक, दिनांक, कंत्राटाच्या कामाचे नांव, संकेतांक तसेच महानगरपालिकेच्या संबंधित खात्याचे नांव इत्यादि तपशील नमूद केलेला असणे आवश्यक आहे. जेणेकरून प्रस्तुत पत्रव्यवहाराच्या अनुषंगाने महानगरपालिकेला सत्वर उचित कार्यवाही करता येईल.

कंत्राटदार/पुरवठादार यांच्याकडून सादर करण्यात येणारी बँक हमीपत्रे (बँकर्स गॅरंटी) स्वीकारण्या संदर्भातील उपरोल्लेखित सूचनांची नोंद घेऊन त्या अनुषंगाने कार्यवाही करण्यात यावी, अशी सर्व खातेप्रमुख,सहाय्यक महापालिका आयुक्त आणि संबंधित यांना विनंती आहे.

सही /- ०४.१२.२०१२

प्रमुख लेखापाल (वित्त)

परिपत्रक

२०१२-१३

क्र.सीए/एफबीके/ ३९, दिनांक ०७/१२/२०१२

-----यांना प्रत (-----) अधिक प्रतींसह  
माहितीकरिता व योग्य त्या कार्यवाहीसाठी पाठवित आहे.

10/12/12

प्रमुख लेखापाल (वित्त) यांजकरिता

## बृहन्मुंबई महानगरपालिका

### परिपत्रक

२०१४-१५

क्रमांक :- सीए/एफबीके/२५, दिनांक ३०/१०/२०१४

विषय :- बँकेने दिलेले हमीपत्र (बँकर्स गॅरन्टी) स्वीकारण्याबाबत.

संदर्भ :- सीए/एफबीके/३९, दिनांक ०७/१२/२०१२

कंत्राटदार / पुरवठा यांच्याकडून सादर करण्यात येणारी बँक हमीपत्रे (बँकर्स गॅरन्टी) स्वीकारण्यासंदर्भात उपरोक्त संदर्भाधीन परिपत्रकान्वये मार्गदर्शनपर सूचना परिक्रमित करण्यात आल्या आहेत. सदर परिपत्रकातील परिच्छेद क्रमांक २ मध्ये नमूद करण्यात आलेल्या बँकांच्या प्रवर्गात नागरी सहकारी बँकांचा (Urban Co- Operative Banks) उल्लेख नसल्याने सदर परिच्छेद पुढीलप्रमाणे सुधारित करण्यात येत आहे.

“रिझर्व बँक ऑफ इंडिया यांनी त्यांच्या 'rbidocs.rbi.org.in/rdocs/publications/pdfs/84656.pdf' ह्या अधिकृत वेबसाईटवर रिझर्व बँक ऑफ इंडिया अधिनियम, १९३४ अन्वयेची अनुसूची-दोन माहितीकरीता उपलब्ध केलेली आहे. सदर अनुसूची-दोन मध्ये (१) स्टेट बँक ऑफ इंडिया आणि तिच्या संलग्न बँका, (२) राष्ट्रीयीकृत बँका, (३) इतर सार्वजनिक क्षेत्रातील बँका, (४) खाजगी क्षेत्रातील बँका, (५) विदेशी बँका आणि (६) नागरी सहकारी बँका हा प्रवर्गात नमूद करण्यात आलेल्या बृहन्मुंबई महानगरपालिका तसेच त्यापुढील विरार व कल्याण पर्यंतच्या क्षेत्रातील सर्व बँकांच्या शाखा, बँक हमीपत्रे स्वीकारण्याबाबतच्या प्रयोजनाकरीता मान्यताप्राप्त आहेत.”

तरी, सर्व खातेप्रमुख, सहाय्यक महापालिका आयुक्त आणि संबंधित यांनी वरील सुधारणेची कृपया नोंद घ्यावी अशी विनंती आहे.

सही/२२.१०.२०१४

प्रमुख लेखापाल (वित्त)

परिपत्रक

२०१४-१५

क्र.सीए/एफबीके/२५, दिनांक ३०/१०/२०१४

-----यांना प्रत (-----) अधिक प्रतींसह

माहितीकरिता व योग्य त्या कार्यवाहीसाठी पाठवित आहे.

*Rhandolkar*  
11/11/14  
प्रमुख लेखापाल (वित्त) यांजकरिता

D/BANK GUARANTY 2012

BMP- J-17643-2014-15-2500

## बृहन्मुंबई महानगरपालिका

### परिपत्रक

२०१९-२०

क्रमांक : सीए/एफबीके/२४९, दिनांक २७.११.२०१९

विषय : बँकेने दिलेले हमीपत्र (बँकरा गॅरंटी) स्विकारण्याबाबत.

संदर्भ : सीए/एफबीके/३९, दिनांक - ०७/१२/२०१२

सीए/एफबीके/२५, दिनांक - ३०/१०/२०१४

कंत्राटदार / पुरवठादार यांच्याकडून सादर करण्यात येणारी बँक हमीपत्रे (बँकरा गॅरंटी) स्विकारण्यासंदर्भात उपरोक्त संदर्भाधीन परिपत्रकान्वये मार्गदर्शनपर सूचना परिक्रमित करण्यात आल्या आहेत. सादर परिपत्रकातील परिच्छेद क्रमांक २ मध्ये पुढील प्रमाणे सुधारणा करण्यात येत आहेत.

सादर परिपत्रकात नमूद केलेली भारतीय रिझर्व बँकेची "rbidocs.rbi.org.in/rdocs/publications/pdfs/84656.pdf" ही लिंक "www.rbi.org.in" अशी वाचण्यात यावी.

तरी, सर्व खातेप्रमुख, सहाय्यक महापालिका आयुक्त आणि संबंधित यांनी वरील सुधारणेची नोंद घेऊन संबंधित कंत्राटदार/पुरवठादार यांना अवगत करावे.

सही/- १४.११.२०१९  
प्रमुख लेखापाल (पा.पु.म.नि.)

सही/- १४.११.२०१९  
प्रमुख लेखापाल (वित्त) प्र.

### परिपत्रक

२०१९-२०

क्रमांक : सीए/एफबीके/२४९, दिनांक २७.११.२०१९

----- यांना प्रत (-----) अधिक प्रतीसह  
माहितीकरिता व योग्य त्या कार्यवाहीसाठी पाठवित आहे.

सादर परिपत्रक महानगरपालिकेच्या <ftp://hr.mcgm.gov.in/Circular/CA/Finance/2019/> या संकेतस्थळावर प्रसिद्ध करण्यात आलेले आहे.

वि.प्र. कश्यप  
प्रमुख लेखापाल (वित्त) यांजकरिता

NS3429-CA-BMPP-39772-2019-20-2200(copies)

G:\SANDIP LETTERS - 2.doc77



## Annexure-N

### MUNICIPAL CORPORATION OF GREATER MUMBAI

#### CIRCULAR

No.CA (F)/Project/31 Dt. 26/10/2020.

**Subject:** - Revised Policy for Governing Extra-excess-saving

**Ref:-** 1. Circular No.CA/FRD/I/57 dt.13.03.2013.

2. Circular No. Dir/E.S.&P./324 dt.15.07.2015.

At present the extra/excess/saving proposals are dealt as per Decision Rules framed under circular No.CA/FRD/I/57 of 13.03.2013 &Dir/E.S.&P./324 dt.15.07.2015.

Hon'ble M.C. has directed to review the existing Decision Rules and amend it suitably. Accordingly, in view to exercising effective control over the extra/excess and speedy process of such proposal during execution of the work, the powers of approval of extra/excess /saving and Fair items are reviewed and delegated according to the attached modified statement-"A". Except this, other conditions of Circular No. DIR./E.S.&P./324 dt.15.07.2015 shall remain unchanged and will be applicable as it is.

The "Decision Rules" framed and circulated apropos circular No.CA/FRD/I/57 of 13.03.2013 and Dir/ES&P/324 of 15.07.2015 shall remain applicable for those extra/excess works which were executed before issuance of these amended rules/directives by obtaining prior administrative approval of competent authority, as the case may be.

The revised policy for governing Extra/Excess and Fair items will come into effect immediately from the issuance of this circular.

All Chief Engineers/ Head of Departments/Deans shall note the above directives and follow them scrupulously.

Sd/- 13.10.2020

C. A. (WSSD)

Sd/- 13.10.2020

C. A. (Finance)i.c.

Sd/- 13.10.2020

D.M.C. (Infra)

Sd/- 13.10.2020

D.M.C.(E.)

Sd/- 14.10.2020

D.M.C.(S.E.)

Sd/- 13.10.2020

Dir.(E.S.&P.)

Sd/- 16.10.2020

A.M.C. (Project)

Sd/- 23.10.2020

Municipal Commissioner

**Statement –A**

**(i) Extra/Excess/Saving**

Nature of work	Permissible limit of Extra/Excess/Saving and Approving authority		
	DMC (Infra)/ DMC(E)/ DMC(SE)/ Dir(ES&P)/ Jt.M.C.	Concerned A.M.C.	Municipal Commissioner
General Work/ Underground works/ Unforeseen works	<p>(i) <u>Cumulative</u> amount of Extra/Excess/Saving in any <u>individual item</u> Upto Rs.25 Lakh And</p> <p>(ii) Total <u>Cumulative</u> amount of Extra/Excess/Saving <u>on all items</u> upto 5% of the total contract cost, but not exceeding Rs.1 crore</p>	<p>(i) <u>Cumulative</u> amount of Extra/Excess/Saving in any <u>individual item</u> Upto Rs.1crore And</p> <p>(ii)Total <u>Cumulative</u> amount of Extra/Excess/Saving <u>on all items</u> upto 15 % of the total contract cost, but not exceeding Rs.10 crore</p>	<p>(i) <u>Cumulative</u> amount of Extra/Excess/Saving in any <u>individual item</u> above Rs.1Crore And / OR</p> <p>(ii)Total <u>Cumulative</u> amount of Extra/Excess/Saving <u>on all items</u> above 15% of the total contract cost. And / OR <u>Cumulative</u> amount of Extra/Excess/Saving <u>on all items</u> exceeding Rs.10 Crores.</p>
<b><u>Payment Terms:</u></b>			
<u>Excess Items</u> shall be paid as per the rates quoted by the tenderer at the time of tender			
<u>Extra Items</u> shall be paid as per the rate prevailing in “Unified Schedule of Rate” of MCGM at the time of tender at rebate quoted by the contractor or at Par in case of premium quoted by the contractor at the time of tender			

(ii) Fair Item

Nature of work	Permissible limit of Fair Item and Approving authority		
	DMC(Infra)/ DMC(E)/ DMC(SE)/ Dir(ES&P)/ Jt.M.C.	Concerned A.M.C.	Municipal Commissioner
For all nature of work	Total <u>Cumulative</u> amount of Fair <u>on all items</u> upto 2% of the total contract cost, but not exceeds Rs.20 Lakh	Total <u>Cumulative</u> amount of Fair <u>on all items</u> upto 5 % of the total contract cost, but not exceeds Rs.1 crore  (Other than the proposals in the purview of DMC/Jt.MC)	Total <u>Cumulative</u> amount of Fair <u>on all items</u> above 5% of the total contract cost. And / OR <u>Cumulative</u> amount of Fair <u>on all items</u> exceeding Rs.1 Crore.

Payment Terms:

Fair Items shall be got approved by the concerned DMC/Dir(ES&P)/Jt.M.C. The engineer in-charge shall work out these fair items at fair and reasonable market rates on the basis of material, labour and operation of construction equipment required to execute the item and allowing 15% to cover profits and overhead charges(i.e. including taxes, duties, etc.) On the same lines of rate analysis prepared for the items that are in "Unified Schedule of Rate" of MCGM.

The rates of Fair Items shall be valid for one year only. Moreover, no escalation will be admissible on the fair items till the completion of such works, in which the fair items are executed.

Fair Items shall be paid at PAR in case of premium quoted by the contractor, in newly created FAIR ITEM or item not included in prevailing "Unified Schedule of Rate" of MCGM at the time of tender. OR at rebate quoted by the contractor if it is already added in prevailing "Unified Schedule of Rate" of MCGM at the time of tender.

Sd/- 13.10.2020

Sd/- 13.10.2020

Sd/- 13.10.2020

Sd/- 13.10.2020

Sd/-14.10.2020

Sd/-13.10.2020

C. A. (WSSD)

C. A. (Finance)i.c.

D.M.C.(Infra)

D.M.C.(E.)

D.M.C.(S.E.)

Dir.(E.S.&P.)

## Annexure-O

### MUNICIPAL CORPORATION OF GREATER MUMBAI

Office of the DMC CPD,  
Central Purchase Department,  
566, N.M.Joshi Marg, Byculla, Mumbai-400 011.

✓ No. DyChE/ CPD/ 2025 / dt. 01/09/2021

#### CIRULAR

**Sub:** Formation of Grievance Redressal Committee (GRC)  
to address grievances from bidders.

**Ref.:** MGC/F/4961 dated 09/08/2021.

Hon. M.C.'s accorded sanction under reference to form Grievance Redressal Committee (GRC) to address grievances from the bidders regarding responsiveness/ non-responsiveness in Packets 'A', 'B' or 'C' in all the tenders. Therefore, all HOD's are requested to incorporate following condition in all the tenders;

#### Grievance Redressal Committee (GRC)

1. *If a Bidder is not satisfied with the decision of responsiveness/ non responsiveness in Packets 'A', 'B' or 'C', by the concerned HOD, he may appeal to D.M.C. (C.P.D.) by paying fee of Rs. 25,000/-.*
2. *D.M.C. (C.P.D.) will assign the work of co-ordination of various activities and administration work of G.C.R. to nominated Registrar – Shri. Uday B. Mande.*
3. *The Committee for hearing grievances and passing orders will be constituted as follows:*
  - (a) *The Committee will comprise of D.M.C. / Director / Jt.M.C. of tender inviting department and D.M.C. / Director / Jt.M.C. of the department for which tender is being invited.*

*For example, if tender is invited by C.P.D. dept, for K.E.M. Hospital then the Committee will be of DMC(CPD) and DMC (PH).*

- (b) *In case the tender inviting department and department for which tender is being invited are same then the concerned DMC/ Director/ Jt.M.C. of the same department and DMC(CPD) will be the members of the Committee.*

*For example, if tender is invited by Dean (KEM) for KEM Hospital then the Committee will be DMC (PH) and DMC(CPD).*

In tabular format:

<b>Tender inviting Department</b>	<b>Work belonging Department</b>
DMC(CPD) or DMC /Director / Jt.M.C. of concerned Department.	Concerned DMC / Director/ Jt.M.C.

4. In case the work is pertaining to various departments then concerned DMC / Director/ Jt.M.C. having major contribution of work will be one of the member of the Committee.
5. The Committee will hear the grievances of bidder within 30 days on receipt of bidder's application and will pass an order within 45 days.
6. If Bidder is not satisfied with the decision of the above Committee, he may appeal to the concerned Addl. Municipal Commissioner of Tender Inviting Department. The Addl. Municipal Commissioner will hear the case within 45 days from the date of receipt of application for second appeal from the bidder and will pass the order within 60 days.

Sd/- 27.07.2021  
Dy ChE (Civil) CPD

sd/- 27.07.2021  
D.M.C. (C.P.D.)

Sd/- 30.07.2021  
A.M.C. (WS)

sd/- 06.08.2021  
Hon,ble M. C.

The above circular approved by Hon,ble MC is submitted for necessary action please.

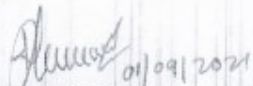
  
Dy ChE (CPD) Civil

## ANNEXURE

### GRIEVANCE REDRESSAL MECHANISM

BMC has formed a Grievance Redressal Mechanism for redressal of bidder's grievances. Any Bidder or prospective Bidder aggrieved by any decision, action or omission of the procuring entity being contrary to the provisions of the tender or any rules or guidelines issued therein, in Packet 'A', 'B' & 'C' can make an application for review of decision of responsiveness in Packet 'A', 'B' & 'C' within a period of 7 days or any such other period, as may be specified in the Bid document.

While making such an application to procuring entity for review, aggrieved bidders or prospective bidders shall clearly specify the ground or grounds in respect of which he feels aggrieved.

Provided that after declaration of a bidder as a successful in Packet 'A' (General Requirements), an application for review may be filed only by a bidder who has participated in procurement proceedings and after declaration of successful bidder in Packet 'B' (Technical Bid), an application for review may be filed only by successful bidders of Packet 'A'. Provided further that, an application for review of the financial bid can be submitted, by the bidder whose technical bid is found to be acceptable / responsive.

Upon receipt of such application for review, BMC may decide whether the bid process is required to be suspended pending disposal of such review. The BMC after examining the application and the documents available to him, give such reliefs, as may be considered appropriate and communicate its decision to the Applicant and if required to other bidders or prospective bidders, as the case may be.

BMC shall deal and dispose off such application as expeditiously as possible and in any case within 10 days from the date of receipt of such application or such other period as may be specified in pre-qualification document, bidder registration document or bid documents, as the case may be.

Where BMC fails to dispose off the application within the specified period or if the bidder or prospective bidder feels aggrieved by the decision of the procuring entity, such bidder or prospective bidder may file an application for redressal before the "Internal Procurement Redressal Committee" within 7 days of the expiry of the allowed time or of the date of receipt of the decision, as the case may be. Every such application for internal redressal before Redressal Committee shall be accompanied by fee of Rs.25,000/- and fee shall be paid in the form of D.D. in favour of M.C.G.M.

**1<sup>st</sup> Appeal by the bidder against the decision of C.E./ HOD/ Dean can be made to concerned DMC/Director who should decide appeal in 7 days.**

**If not satisfied, 2<sup>nd</sup> Appeal by the bidder can be made to concerned A.M.C. for decision.**

Grievance Redressal Committee (GRC) is headed by concerned D.M.C./ Director of particular department for the first appeal/ grievances by the bidder against the decision for responsiveness / non- responsiveness in Packet 'A', Packet 'B' or Packet 'C' and if not satisfied, concerned A.M.C. will take decision as per second appeal made by the bidder.

**This Grievance Redressal Committee (GRC) will be operated through DMC (CPD) office where appeals of aggrieved bidder will be received with fee of Rs. 25,000/- from aggrieved bidder. The necessary correspondence in respect of said applications to the aggrieved bidder & concerned department, issuing notices, arranging of Grievance Redressal Committee (GRC) with D.M.C. and further proceeding will be carried out through registrar appointed by MCGM.**

No application shall be maintainable before the redressal Committee in regard of any decision of the BMC relating to following issues:

Determination of need of procurement

The decision of whether or not to enter into negotiations.

Cancellation of a procurement process for certain reasons.

On receipt of recommendation of the Committee, It will be communicate his decision thereon to the Applicant within 10 days or such further time not exceeding 20 days, as may be considered necessary from the date of receipt of the recommendation and in case of non-acceptance of any recommendation, the reason of such non-acceptance shall also be mentioned in such communication.

Additional Municipal Commissioner and/or Grievance Redressal Committee, if found, come to the conclusion that any such complaint or review is of vexatious, frivolous or malicious nature and submitted with the intention of delaying or defeating any procurement or causing loss to the procuring entity or any other bidder, then such complainant shall be punished with fine, which may extend to Five Lac rupees or two percent of the value of the procurement, whichever is higher.

Full Signature of the tenderer with

Official Seal and Address

## Annexure-P

बृहन्मुंबई महानगरपालिका

परिपत्रक

२०२३-२०२४

क्र. सीए/एफआरजी/१८ दिनांक २७.०२.२०२४

विषय:- महानगरपालिकेच्या विविध खात्यांमार्फत मागविण्यात येणा-या अनस्टार दरपत्रिका / निविदा / दरपत्रिका / ई-दरपत्रिका / ई-निविदा दस्तऐवजांच्या किंमतीच्या दरात वाढ करण्याबाबत

- संदर्भ :- १) परिपत्रक क्र.सीए/एफआरजी/०३ दि. ११.०५.२०२३  
२) परिपत्रक क्र.सीए/एफआरजी/०४ दि. २४.०५.२०२३  
३) परिपत्रक क्र.सीए/एफआरजी/१० दि. १९.१०.२०२३

बृहन्मुंबई महानगरपालिकेच्या विविध खात्यांमार्फत मागविण्यात येणाऱ्या अनस्टार दरपत्रिका / निविदा / दरपत्रिका / ई-दरपत्रिका / ई-निविदा दस्तऐवज याबाबत आकारावयाचे छाननी शुल्क उपरोक्त संदर्भ क्र. ०१ वरील परिपत्रकानुसार दिनांक ११.०५.२०२३ पासून दिनांक ३१.०३.२०२४ पर्यंत आकारण्याबाबत निर्देश देण्यात आले होते. तसेच उपरोक्त संदर्भ क्र. १ च्या परिपत्रकात मा. अतिरिक्त आयुक्त (प्रकल्प) यांच्या मंजूरी अन्वये वेळेवेळी सुधारणा करून उपरोक्त संदर्भ क्र. २ व ३ ची परिपत्रके निर्गमित करण्यात आली आहेत.

दिनांक ११.०५.२०२३ पासून लागू करण्यात आलेल्या अनस्टार दरपत्रिका / निविदा / दरपत्रिका / ई-दरपत्रिका / ई-निविदा दस्तऐवजांकरिता आकारावयाच्या छाननी शुल्क दरांमध्ये परिपत्रक क्र. सीए/एफआरएम/७ दि. ०३.०५.२०२१ व परिपत्रक क्र. सीए/एफआरएम/४९ दि. ०७.०२.२०१३ अन्वये सन २०२४-२५ या वर्षामध्ये १०% वाढ करण्यात येत आहे. तसेच महानगरपालिकेचे वस्तू व सेवाकर सल्लागार एकबोटे देशमुख अँड कंपनी यांच्या दि. १८.०४.२०२३ रोजी प्राप्त झालेल्या अभिप्रायानुसार सदर छाननी शुल्कावर (Scrutiny Fee) १८% दराने वस्तू व सेवाकर लागू आहे. त्यानुसार आकारावयाच्या छाननी शुल्काचे सुधारित दर खालीलप्रमाणे आहेत :-



अनु क्र.	स्वारस्याची अभिव्यक्ती प्रस्ताव/ मालाचा पुरवठा/ सल्लागार सेवासह स्थापत्य कामे आणि सेवा इत्यादी विषयक कार्यालयीन अंदाजे रक्कम	अनस्टार दरपत्रिका/निविदा/दरपत्रिका/ ई-दरपत्रिका/ ई-निविदा दस्तऐवजांचे विद्यमान छाननी शुल्क (दि. ११.०५.२०२३ पासून दि. ३१.०३.२०२४ पर्यंत)	दि. ०१.०४.२०२४ पासून दि. ३१.०३.२०२५ पर्यंत मागविण्यात येणाऱ्या अनस्टार दरपत्रिका/निविदा/दरपत्रिका/ ई-दरपत्रिका/ ई-निविदा दस्तऐवजांचे सर्व देकारदारांकडून वसूल करावयाचे छाननी शुल्क
०१	रु. ०३ लाखापर्यंत	रु. ३००/- + १८% वस्तू व सेवाकर	रु. ३३०/- + १८% वस्तू व सेवाकर
०२	रु. ३,००,००१/- ते रु. ५,००,०००/-	रु. ६००/- + १८% वस्तू व सेवाकर	रु. ६६०/- + १८% वस्तू व सेवाकर
०३	रु. ५,००,००१/- ते रु. १०,००,०००/-	रु. १,२००/- + १८% वस्तू व सेवाकर	रु. १,३२०/- + १८% वस्तू व सेवाकर
०४	रु. १०,००,००१/- ते रु. २५,००,०००/-	रु. ३,०००/- + १८% वस्तू व सेवाकर	रु. ३,३००/- + १८% वस्तू व सेवाकर
०५	रु. २५,००,००१/- ते रु. ५०,००,०००/-	रु. ६,०००/- + १८% वस्तू व सेवाकर	रु. ६,६००/- + १८% वस्तू व सेवाकर
०६	रु. ५०,००,००१/- ते रु. १,००,००,०००/-	रु. १२,०००/- + १८% वस्तू व सेवाकर	रु. १३,२००/- + १८% वस्तू व सेवाकर
०७	रु. १,००,००,००१/- ते रु. २५,००,००,०००/-	रु. १५,०००/- + १८% वस्तू व सेवाकर	रु. १६,५००/- + १८% वस्तू व सेवाकर

2-67683

०८	रु. २५,००,००,००१/- पेक्षा जास्त	रु. २५,०००/- + १८% वस्तू व सेवाकर	रु. २७,५००/- + १८% वस्तू व सेवाकर

अनस्टार दरपत्रिका/ निविदा/ दरपत्रिका/ ई-दरपत्रिका/ई-निविदा दस्तऐवजांकरिता छाननी शुल्काचे सुधारीत दर दि. ०१.०४.२०२४ ते दि. ३१.०३.२०२५ पर्यंत लागू राहतील.

तरी सर्व खाते प्रमुख/सहाय्यक आयुक्त / रुग्णालय प्रमुख / अधिष्ठाता यांनी त्यांच्या अखत्यारीतील संबंधित कर्मचारी वृंदाना उपरोक्त सुचनेची काटेकोरपणे अंमलबजावणी करण्याचे तसेच दिनांक ०१.०४.२०२४ पासून मागविण्यात येणाऱ्या अनस्टार दरपत्रिका / निविदा / दरपत्रिका / ई-दरपत्रिका / ई-निविदा दस्तऐवजांकरिता या परिपत्रकातील सुधारीत किंमतीनुसार दर आकारण्याचे निदेश द्यावेत.

सही/- २१.०२.२०२४  
श्री. प्रदीप भा. पडवळ  
प्रमुख लेखापाल (वित्त) प्र.

परिपत्रक

२०२३-२४

क्र.सीए/एफआरजी/१८ दिनांक २७.०२.२०२४

प्रत .....(जादा .....प्रतीसह ) यांना माहितीकरिता व पुढील आवश्यक त्या कार्यवाहीकरिता अर्पित.

*DBaagwe*  
०१/३/२०२४  
प्रमुख लेखापाल (वित्त) यांजकरिता

NS 5656 CA - BMPP - 67683 - 2023 - 24 - 2200 00 00 00

बृहन्मुंबई महानगरपालिका

परिपत्रक  
२०२३-२०२४

क्र. सीए/एफआरजी/ १० दिनांक १९.१०.२०२३

विषय :- महानगरपालिकेच्या विविध खात्यांमार्फत मागविण्यात येणा-या अनस्टार दरपत्रिका/  
निविदा/दरपत्रिका/ ई-दरपत्रिका/ ई-निविदा दस्तऐवजांच्या छाननी शुल्काबाबत

संदर्भ :- १) प्रले/एफसीई/२८ दि. १३.०१.२०२३

२) परिपत्रक क्र. सीए/एफआरजी/२१ दिनांक ०८.०२.२०२३

३) एमजीसी/एफ/९५८५ दि. ११.०५.२०२३

४) परिपत्रक क्र. सीए/एफआरजी/०३ दिनांक ११.०५.२०२३

५) अति.आ./प्रकल्प/१३५१ दि. २३.०५.२०२३

६) परिपत्रक क्र. सीए/एफआरजी/०४ दि. २४.०५.२०२३

बृहन्मुंबई महानगरपालिकेच्या विविध खात्यांमार्फत मागविण्यात येणाऱ्या अनस्टार दरपत्रिका/निविदा/दरपत्रिका/ ई-दरपत्रिका/ई-निविदा दस्तऐवजांकरिता छाननी शुल्क आकारण्याबाबत उपरोक्त संदर्भ क्र. ४ व ६ अन्वये परिपत्रक निर्गमित करण्यात आले होते. परिपत्रक क्र. सीए/एफआरजी/०३ दिनांक ११.०५.२०२३ मध्ये पुढील प्रमाणे निर्देश देण्यात आले आहेत.

“सर्व खाते प्रमुख/सहाय्यक आयुक्त/रुग्णालय प्रमुख, अधिष्ठाता यांनी त्यांच्या अखत्यारीतील संबंधित कर्मचारीवृंदाना उपरोक्त सुचनेची काटेकोरपणे अंमलबजावणी करण्याचे तसेच मंजुरीच्या दिनांकापासून मागविण्यात येणाऱ्या अनस्टार दरपत्रिका/ निविदा/ दरपत्रिका/ ई-दरपत्रिका/ई-निविदा दस्तऐवजांकरिता निविदा शुल्क न आकारता सर्व देकारदारांकडून या परिपत्रकातील सुधारित दरांनुसार इसारा अनामत रक्कमेचा परतावा करण्यापूर्वी छाननी शुल्क अनुज्ञेय वस्तू व सेवाकरासहित वसूल करण्याचे अथवा देकारदाराच्या संमतीने इसारा अनामत रक्कमेतून समायोजित करण्यासंबंधीचे निदेश द्यावेत. ”

तदनंतर सुधारित परिपत्रक क्र. सीए/एफआरजी/०४ दि. २४.०५.२०२३ निर्गमित करण्यात आले. सदर परिपत्रकात पुढील प्रमाणे निर्देश देण्यात आले आहेत.

“दरपत्रिका/निविदा/दरपत्रिका/ई-दरपत्रिका/ई-निविदा दस्तऐवजांकरिता मा. महानगरपालिका आयुक्तांच्या मंजुरीच्या दिनांकापासून छाननी शुल्क न आकारता, एसआरएम कार्यप्रणाली मध्ये निविदा शुल्क न आकारण्यासंबंधीची कार्यवाही माहिती व तंत्रज्ञान खात्याकडून पूर्ण झाल्यावर त्यानंतरच निविदाकाराकडून छाननी शुल्क आकारण्यात यावेत. तसेच सदर छाननी शुल्काचा भरणा लेखा संकेताक 140402609 - Scrutiny Fees From Tenders (From May 2023)-Taxable यामध्ये करण्यात यावा.”

परिपत्रक क्र. सीए/एफआरजी/०४ दि. २४.०५.२०२३ मध्ये नमूद केल्यानुसार एसआरएम प्रणाली मध्ये आवश्यक ते बदल माहित व तंत्रज्ञान विभागाकडून दि. २३.०६.२०२३ रोजी पूर्ण करण्यात आले आहेत.

दरम्यान माहिती व तंत्रज्ञान विभागामार्फत परिपत्रक क्र. Dir/IT/F-59 दि. १०.०५.२०२३ निर्गमित करण्यात आले. सदर परिपत्रकामध्ये दि. १५.०६.२०२३ पासून रु.२५ लाखावरील सर्व निविदा महानगरपालिकेच्या एसआरएम प्रणालीद्वारे न मागविता महाराष्ट्र शासनाच्या महाटॅंडर पोर्टलद्वारे मागविण्याबाबत निर्देश देण्यात आले आहेत. तसेच परिपत्रक क्र. सीए/एफआरजी/०३ दिनांक ११.०५.२०२३ मध्ये इसारा अनामत रक्कमेचा परतावा करण्यापूर्वी छाननी शुल्क, अनुज्ञेय वस्तू व सेवाकरासहित वसूल करण्याचे अथवा देकारदाराच्या संमतीने इसारा अनामत रक्कमेतून समायोजित करण्यासंबंधीचे निदेश देण्यात आले आहेत. तथापि महाराष्ट्र शासनाच्या महाटॅंडर पोर्टलवर इसारा अनामत रक्कमेतून समायोजना करण्याची सुविधा नसल्याने पुढील प्रमाणे सुधारित निर्देश देण्यात येत आहेत.

"महाराष्ट्र शासनाच्या महाटॅंडर / एसआरएम प्रणालीद्वारे मागविण्यात येणारे सर्व अनस्टार दरपत्रिका/निविदा/दरपत्रिका/ ई-दरपत्रिका/ ई-निविदा दस्तऐवजांकरिता निविदा शुल्क (Tender Fee) न आकारता सर्व देकारदारांकडून परिपत्रक क्र. सीए/एफआरजी/०३ दिनांक ११.०५.२०२३ मधील सुधारित दरांनुसार छाननी शुल्क (Scrutiny Fee) अनुज्ञेय वस्तू व सेवाकरासहित लिफाफा 'अ' व 'ब' उघडल्यानंतर व लिफाफा 'क' उघडण्याआधी फक्त नागरी सुविधा केंद्रात चलनाद्वारे भरण्यात यावे."

संदर्भित परिपत्रकातील अन्य निर्देशांमध्ये कोणताही बदल करण्यात आलेला नाही.

सही/-१६.१०.२०२३  
श्री.पांडुरंग गोसावी  
प्रमुख लेखापाल (पा.पु.म.नि.)

सही/-१६.१०.२०२३  
श्री. प्रदिप भा. पडवळ  
प्रमुख लेखापाल (वित्त)प्र.

सही/-१६.१०.२०२३  
श्री. प्रशांत गायकवाड  
उप. आयुक्त (वित्त) प्र.

सही/-१८.१०.२०२३  
श्री. पी. वेलरासू  
अति.आयुक्त (प्रकल्प)

परिपत्रक

२०२३-२४

क्र.सीए/एफआरजी/१० दिनांक १९.१०.२०२३

प्रत .....(जादा .....प्रतीसह ) यांना माहितीकरिता व पुढील  
आवश्यक त्या कार्यवाहीकरिता अग्रेषित.

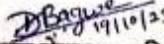
  
प्रमुख लेखापाल (वित्त) यांजकरिता

## Annexure-Q

F.No.6/18/2019-PPD  
Ministry of Finance  
Department of Expenditure  
Public Procurement Division

161, North Block,  
New Delhi  
23rd July, 2020

### Office Memorandum

**Subject: Insertion of Rule 144 (xi) in the General Financial Rules (GFRs), 2017**

Rule 144 of the General Financial Rules 2017 entitled 'Fundamental principles of public buying', has been amended by inserting sub-rule (xi) as under:

*Notwithstanding anything contained in these Rules, Department of Expenditure may, by order in writing, impose restrictions, including prior registration and/or screening, on procurement from bidders from a country or countries, or a class of countries, on grounds of defence of India, or matters directly or indirectly related thereto including national security; no procurement shall be made in violation of such restrictions.*

  
(Sanjay Prasad)

Joint Secretary (PPD)

Email ID: [js.pfc2.doe@gov.in](mailto:js.pfc2.doe@gov.in)

Telephone: 011-23093882

To,

- (1) Secretaries of All Ministries/ Departments of Government of India
- (2) Chief Secretaries/ Administrators of Union Territories/ National Capital Territory of Delhi

F.No.6/18/2019-PPD  
Ministry of Finance  
Department of Expenditure  
Public Procurement Division

161, North Block,  
New Delhi  
23rd July, 2020

**Order (Public Procurement No. 1)**

**Subject: Restrictions under Rule 144 (xi) of the General Financial Rules (GFRs), 2017**

Attention is invited to this office OM no. 6/18/2019-PPD dated 23<sup>rd</sup> July 2020 inserting Rule 144 (xi) in GFRs 2017. In this regard, the following is hereby ordered under Rule 144 (xi) on the grounds stated therein:

**Requirement of registration**

1. Any bidder from a country which shares a land border with India will be eligible to bid in any procurement whether of goods, services (including consultancy services and non-consultancy services) or works (including turnkey projects) only if the bidder is registered with the Competent Authority, specified in **Annex I**.
2. This Order shall not apply to (i) cases where orders have been placed or contract has been concluded or letter/notice of award/ acceptance (LoA) has been issued on or before the date of this order; and (ii) cases falling under **Annex II**.

**Transitional cases**

3. Tenders where no contract has been concluded or no LoA has been issued so far shall be handled in the following manner: -
  - a) *In tenders which are yet to be opened, or where evaluation of technical bid or the first exclusionary qualificatory stage (i.e. the first stage at which the qualifications of tenderers are evaluated and unqualified bidders are excluded) has not been completed: No contracts shall be placed on bidders from such countries. Tenders received from bidders from such countries shall be dealt with as if they are non-compliant with the tender conditions and the tender shall be processed accordingly.*
  - b) *If the tendering process has crossed the first exclusionary qualificatory stage: If the qualified bidders include bidders from such countries, the*

entire process shall be scrapped and initiated *de novo*. The *de novo* process shall adhere to the conditions prescribed in this Order.

- c) As far as practicable, and in cases of doubt about whether a bidder falls under paragraph 1, a certificate shall be obtained from the bidder whose bid is proposed to be considered or accepted, in terms of paras 8, 9 and 10 read with para 1 of this Order.

#### Incorporation in tender conditions

4. In tenders to be issued after the date of this order, the provisions of paragraph 1 and of other relevant provisions of this Order shall be incorporated in the tender conditions.

#### Applicability

5. Apart from Ministries / Departments, attached and subordinate bodies, notwithstanding anything contained in Rule 1 of the GFRs 2017, this Order shall also be applicable
  - a. to all Autonomous Bodies;
  - b. to public sector banks and public sector financial institutions; and
  - c. subject to any orders of the Department of Public Enterprises, to all Central Public Sector Enterprises; and
  - d. to procurement in Public Private Partnership projects receiving financial support from the Government or public sector enterprises/ undertakings.
  - e. Union Territories, National Capital Territory of Delhi and all agencies/ undertakings thereof

#### Definitions

6. "Bidder" for the purpose of this Order (including the term 'tenderer', 'consultant' 'vendor' or 'service provider' in certain contexts) means any person or firm or company, including any member of a consortium or joint venture (that is an association of several persons, or firms or companies), every artificial juridical person not falling in any of the descriptions of bidders stated hereinbefore, including any agency, branch or office controlled by such person, participating in a procurement process.
7. "Tender" for the purpose of this Order will include other forms of procurement, except where the context requires otherwise.
8. "Bidder from a country which shares a land border with India" for the purpose of this Order means

- a) An entity incorporated, established or registered in such a country; or
- b) A subsidiary of an entity incorporated, established or registered in such a country; or
- c) An entity substantially controlled through entities incorporated, established or registered in such a country; or
- d) An entity whose *beneficial owner* is situated in such a country; or
- e) An Indian (or other) agent of such an entity; or
- f) A natural person who is a citizen of such a country; or
- g) A consortium or joint venture where any member of the consortium or joint venture falls under any of the above

9. "Beneficial owner" for the purpose of paragraph 8 above will be as under:

- (i) In case of a company or Limited Liability Partnership, the beneficial owner is the natural person(s), who, whether acting alone or together, or through one or more juridical person(s), has a controlling ownership interest or who exercises control through other means.

Explanation—

- a. "Controlling ownership interest" means ownership of, or entitlement to, more than twenty-five per cent of shares or capital or profits of the company;
- b. "Control" shall include the right to appoint the majority of the directors or to control the management or policy decisions, including by virtue of their shareholding or management rights or shareholders agreements or voting agreements;

- (ii) In case of a partnership firm, the beneficial owner is the natural person(s) who, whether acting alone or together, or through one or more juridical person, has ownership or entitlement to more than fifteen percent of capital or profits of the partnership;

- (iii) In case of an unincorporated association or body of individuals, the beneficial owner is the natural person(s), who, whether acting alone or together, or through one or more juridical person, has ownership or entitlement to more than fifteen percent of the property or capital or profits of such association or body of individuals;

- (iv) Where no natural person is identified under (i) or (ii) or (iii) above, the beneficial owner is the relevant natural person who holds the position of senior managing official;



(v) In case of a trust, the identification of beneficial owner(s) shall include identification of the author of the trust, the trustee, the beneficiaries with fifteen percent or more interest in the trust and any other natural person exercising ultimate effective control over the trust through a chain of control or ownership.

10. "Agent" for the purpose of this Order is a person employed to do any act for another, or to represent another in dealings with third persons.

#### Sub-contracting in works contracts

11. In works contracts, including turnkey contracts, contractors shall not be allowed to sub-contract works to any contractor from a country which shares a land border with India unless such contractor is registered with the Competent Authority. The definition of "contractor from a country which shares a land border with India" shall be as in paragraph 8 above. This shall not apply to sub-contracts already awarded on or before the date of this Order.

#### Certificate regarding compliance

12. A certificate shall be taken from bidders in the tender documents regarding their compliance with this Order. If such certificate given by a bidder whose bid is accepted is found to be false, this would be a ground for immediate termination and further legal action in accordance with law.

#### Validity of registration

13. In respect of tenders, registration should be valid at the time of submission of bids and at the time of acceptance of bids. In respect of supply otherwise than by tender, registration should be valid at the time of placement of order. If the bidder was validly registered at the time of acceptance / placement of order, registration shall not be a relevant consideration during contract execution.

#### Government E-Marketplace

14. The Government E-Marketplace shall, as soon as possible, require all vendors/ bidders registered with GeM to give a certificate regarding compliance with this Order, and after the date fixed by it, shall remove non-compliant entities from GeM unless/ until they are registered in accordance with this Order.

Model Clauses/ Certificates

15. Model Clauses and Model Certificates which may be inserted in tenders / obtained from Bidders are enclosed as **Annex III**. While adhering to the substance of the Order, procuring entities are free to appropriately modify the wording of these clauses based on their past experience, local needs etc. without making any reference to this Department.

  
(Sanjay Prasad)

Joint Secretary (PPD)

Email ID: [js\\_pfc2.doe@gov.in](mailto:js_pfc2.doe@gov.in)

Telephone: 011-23093882

To

- (1) Secretaries of All Ministries/ Departments of Government of India for information and necessary action. They are also requested to inform these provisions to all procuring entities.
- (2) Secretary, Department of Public Enterprises with a request to immediately reiterate these orders in respect of Public Enterprises.
- (3) Secretary DPIIT with a request to initiate action as provided under Annex I
- (4) Chief Secretaries/ Administrators of Union Territories/ National Capital Territory of Delhi

## Annex I: Competent Authority and Procedure for Registration

- A. The Competent Authority for the purpose of registration under this Order shall be the Registration Committee constituted by the Department for Promotion of Industry and Internal Trade (DPIIT)\*.
- B. The Registration Committee shall have the following members\*:
- i. An officer, not below the rank of Joint Secretary, designated for this purpose by DPIIT, who shall be the Chairman;
  - ii. Officers (ordinarily not below the rank of Joint Secretary) representing the Ministry of Home Affairs, Ministry of External Affairs, and of those Departments whose sectors are covered by applications under consideration;
  - iii. Any other officer whose presence is deemed necessary by the Chairman of the Committee.
- C. DPIIT shall lay down the method of application, format etc. for such bidders as stated in para 1 of this Order.
- D. On receipt of an application seeking registration from a bidder from a country covered by para 1 of this Order, the Competent Authority shall first seek political and security clearances from the Ministry of External Affairs and Ministry of Home Affairs, as per guidelines issued from time to time. Registration shall not be given unless political and security clearance have both been received.
- E. The Ministry of External Affairs and Ministry of Home Affairs may issue guidelines for internal use regarding the procedure for scrutiny of such applications by them.
- F. The decision of the Competent Authority, to register such bidder may be for all kinds of tenders or for a specified type(s) of goods or services, and may be for a specified or unspecified duration of time, as deemed fit. The decision of the Competent Authority shall be final.
- G. Registration shall not be granted unless the representatives of the Ministries of Home Affairs and External Affairs on the Committee concur\*.
- H. Registration granted by the Competent Authority of the Government of India shall be valid not only for procurement by Central Government and its agencies/ public enterprises etc. but **also for procurement by State Governments and their agencies/ public enterprises etc. No fresh registration at the State level shall be required.**

7/12

- I. The Competent Authority is empowered to cancel the registration already granted if it determines that there is sufficient cause. Such cancellation by itself, however, will not affect the execution of contracts already awarded. Pending cancellation, it may also suspend the registration of a bidder, and the bidder shall not be eligible to bid in any further tenders during the period of suspension.
- J. For national security reasons, the Competent Authority shall not be required to give reasons for rejection / cancellation of registration of a bidder.
- K. In transitional cases falling under para 3 of this Order, where it is felt that it will not be practicable to exclude bidders from a country which shares a land border with India, a reference seeking permission to consider such bidders shall be made by the procuring entity to the Competent Authority, giving full information and detailed reasons. The Competent Authority shall decide whether such bidders may be considered, and if so shall follow the procedure laid down in the above paras.
- L. Periodic reports on the acceptance/ refusal of registration during the preceding period may be required to be sent to the Cabinet Secretariat. Details will be issued separately in due course by DPIIT.

[\*Note:

- i. In respect of application of this Order to procurement by/ under State Governments, all functions assigned to DPIIT shall be carried out by the State Government concerned through a specific department or authority designated by it. The composition of the Registration Committee shall be as decided by the State Government and paragraph G above shall not apply. However, the requirement of **political and security clearance as per para D shall remain and no registration shall be granted without such clearance.**
- ii. Registration granted by State Governments shall be valid only for procurement by the State Government and its agencies/ public enterprises etc. and shall not be valid for procurement in other states or by the Government of India and their agencies/ public enterprises etc.]

8/12

## Annex II: Special Cases

- A. Till 31<sup>st</sup> December 2020, procurement of medical supplies directly related to containment of the Covid-19 pandemic shall be exempt from the provisions of this Order.
- B. *Bona fide* procurements made through GeM without knowing the country of the bidder till the date fixed by GeM for this purpose, shall not be invalidated by this Order.
- C. *Bona fide* small procurements, made without knowing the country of the bidder, shall not be invalidated by this Order.
- D. In projects which receive international funding with the approval of the Department of Economic Affairs (DEA), Ministry of Finance, the procurement guidelines applicable to the project shall normally be followed, notwithstanding anything contained in this Order and without reference to the Competent Authority. Exceptions to this shall be decided in consultation with DEA.
- E. This Order shall not apply to procurement by Indian missions and by offices of government agencies/ undertakings located outside India.

9/12

### Annex III

#### Model Clause /Certificate to be inserted in tenders etc.

(While adhering to the substance of the Order, procuring entities and GeM are free to appropriately modify the wording of the clause/ certificate based on their past experience, local needs etc.)

#### Model Clauses for Tenders

- I. Any bidder from a country which shares a land border with India will be eligible to bid in this tender only if the bidder is registered with the Competent Authority.
- II. "Bidder" (including the term 'tenderer', 'consultant' or 'service provider' in certain contexts) means any person or firm or company, including any member of a consortium or joint venture (that is an association of several persons, or firms or companies), every artificial juridical person not falling in any of the descriptions of bidders stated hereinbefore, including any agency branch or office controlled by such person, participating in a procurement process.
- III. "Bidder from a country which shares a land border with India" for the purpose of this Order means: -
  - a. An entity incorporated, established or registered in such a country; or
  - b. A subsidiary of an entity incorporated, established or registered in such a country; or
  - c. An entity substantially controlled through entities incorporated, established or registered in such a country; or
  - d. An entity whose *beneficial owner* is situated in such a country; or
  - e. An Indian (or other) agent of such an entity; or
  - f. A natural person who is a citizen of such a country; or
  - g. A consortium or joint venture where any member of the consortium or joint venture falls under any of the above
- IV. The *beneficial owner* for the purpose of (iii) above will be as under:
  1. In case of a company or Limited Liability Partnership, the beneficial owner is the natural person(s), who, whether acting alone or together, or through one or more juridical person, has a controlling ownership interest or who exercises control through other means.

Explanation—

    - a. "Controlling ownership interest" means ownership of or entitlement to more than twenty-five per cent. of shares or capital or profits of the company;

10/12

- b. "Control" shall include the right to appoint majority of the directors or to control the management or policy decisions including by virtue of their shareholding or management rights or shareholders agreements or voting agreements;
2. In case of a partnership firm, the beneficial owner is the natural person(s) who, whether acting alone or together, or through one or more juridical person, has ownership or entitlement to more than fifteen percent of capital or profits of the partnership;
  3. In case of an unincorporated association or body of individuals, the beneficial owner is the natural person(s), who, whether acting alone or together, or through one or more juridical person, has ownership or entitlement to more than fifteen percent of the property or capital or profits of such association or body of individuals;
  4. Where no natural person is identified under (1) or (2) or (3) above, the beneficial owner is the relevant natural person who holds the position of senior managing official;
  5. In case of a trust, the identification of beneficial owner(s) shall include identification of the author of the trust, the trustee, the beneficiaries with fifteen percent or more interest in the trust and any other natural person exercising ultimate effective control over the trust through a chain of control or ownership.
- V. An Agent is a person employed to do any act for another, or to represent another in dealings with third person.
- VI. *[To be inserted in tenders for Works contracts, including Turnkey contracts]* The successful bidder shall not be allowed to sub-contract works to any contractor from a country which shares a land border with India unless such contractor is registered with the Competent Authority.

Model Certificate for Tenders (for transitional cases as stated in para 3 of this Order)

*"I have read the clause regarding restrictions on procurement from a bidder of a country which shares a land border with India; I hereby certify that this bidder is not from such a country and is eligible to be considered."*

Model Certificate for Tenders

*"I have read the clause regarding restrictions on procurement from a bidder of a country which shares a land border with India; I certify that this bidder is not from such a country or, if from such a country, has been registered with the*

*Competent Authority. I hereby certify that this bidder fulfills all requirements in this regard and is eligible to be considered. [Where applicable, evidence of valid registration by the Competent Authority shall be attached.]"*

#### Model Certificate for Tenders for Works involving possibility of sub-contracting

*"I have read the clause regarding restrictions on procurement from a bidder of a country which shares a land border with India and on sub-contracting to contractors from such countries; I certify that this bidder is not from such a country or, if from such a country, has been registered with the Competent Authority and will not sub-contract any work to a contractor from such countries unless such contractor is registered with the Competent Authority. I hereby certify that this bidder fulfills all requirements in this regard and is eligible to be considered. [Where applicable, evidence of valid registration by the Competent Authority shall be attached.]"*

#### Model Certificate for GeM:

*"I have read the clause regarding restrictions on procurement from a bidder of a country which shares a land border with India; I certify that this vendor/ bidder is not from such a country or, if from such a country, has been registered with the Competent Authority. I hereby certify that this vendor/ bidder fulfills all requirements in this regard and is eligible to be considered for procurement on GeM. [Where applicable, evidence of valid registration by the Competent Authority shall be attached.]"*



**Annexure - S**

**बृहन्मुंबई महानगरपालिका**  
**परिपत्रक**

प्र.ले./वित्त/प्रकल्प/२८ दि. २८/०३/२०२३

विषय: एकसामायिक दरसूची २०२३ अंतर्भूत करून महानगरपालिकेद्वारे हाती घेण्यात येणारी विविध कामे तसेच प्राप्त करण्यात येणा-या वस्तु व सेवा इत्यादीबाबतच्या ई-निविदा/निविदा/दरपत्रक यामध्ये वस्तु व सेवा कराच्या अनुषंगाने अंतर्भूत करावयाच्या अटीबाबत.

संदर्भ: १) प्र.ले./वित्त/प्रकल्प/२५ दि.१२.०७.२०२२

२) संचालक/अ.से.व प्र./२९१/एमसी दि.३१.०१.२०२३

बृहन्मुंबई महानगरपालिकेद्वारे हाती घेण्यात येणारी विविध कामे तसेच प्राप्त करण्यात येणा-या वस्तु व सेवा इत्यादीबाबतच्या ई-निविदा/निविदा/दरपत्रक यामध्ये वस्तु व सेवा कराच्या अनुषंगाने अंतर्भूत करावयाच्या अटीबाबत संदर्भित क्र. १ वरील परिपत्रकान्वये सूचना प्रसृत केल्या आहेत.

महानगरपालिका आयुक्त यांच्या क्र. एमजीसी/एफ/८७७१ दि. ३०.०१.२०२३ अन्वये एकसमान दरसूची २०२३ प्रसारीत करण्यात आली आहे. सदर एकसामायिक दरसूची २०२३ हि वस्तु व सेवाकर वगळून तयार करण्यात आली आहे. सदर अद्ययावत एकसामायिक दरसूची २०२३ नुसार अंदाजपत्रक तयार करून मागविण्यात आलेल्या/येणा-या ई-निविदा/निविदा/दरपत्रक यांमध्ये वस्तु व सेवाकराच्या अनुषंगाने महानगरपालिकेद्वारे हाती घेण्यात येणारी विविध कामे तसेच प्राप्त करण्यात येणा-या वस्तु

व सेवा इत्यादीबाबतच्या ई-निविदा/निविदा/दरपत्रक यामध्ये संदर्भित क्र.१ अन्वये दिलेल्या अटीमध्ये पुढीलप्रमाणे बदल करण्यात येत आहे.

विद्यमान अट	सुधारित अट
<p>“GST and other state levies/cess which are not subsumed under GST will be applicable. The tenderer shall quote inclusive of all taxes <u>applicable at the time of bid submission</u>. It is clearly understood that BMC will not bear any additional liability towards payment of any Taxes &amp; Duties.</p> <p>Wherever the services to be provided by the Tenderers, falls under Reverse Charge Mechanism, the Price quoted shall be exclusive of GST, but inclusive of Taxes/Duties/Cess other than GST, if any.</p> <p>Rates accepted by BMC shall hold good till completion of work and no additional individual claim shall be admissible on account of fluctuations in market rates; increase in taxes/any other levies / tolls etc. except that payment/recovery for overall market situation shall be made as per Price variation <b>and if there is any subsequent change (after submission of bid) in rate of GST applicable on the work/services to be executed as per tender, i.e. any increase will be reimbursed by BMC whereas any reduction in the rate of GST shall be passed on to BMC as per the provisions of the GST Act.</b></p>	<p>The tenderer shall quote inclusive of all taxes other than GST (<b>Excluding GST</b>), <u>Levies, Duties, Cess etc as applicable at the time of bid submission</u>. GST as applicable shall be paid separately on submission of bills/invoice.</p> <p>Input Tax Credit of GST as available with the bidder will not be claim separately by BMC. However, while quoting the rates benefit of Input Tax Credit or Exemptions shall be passed on to the BMC by way of equivalent reduction in quoted price.</p>

व सेवा इत्यादीबाबतच्या ई-निविदा/निविदा/दरपत्रक यामध्ये संदर्भित क्र.१ अन्वये दिलेल्या अटीमध्ये पुढीलप्रमाणे बदल करण्यात येत आहे.

विद्यमान अट	सुधारित अट
<p>“GST and other state levies/cess which are not subsumed under GST will be applicable. The tenderer shall quote inclusive of all taxes <u>applicable at the time of bid submission</u>. It is clearly understood that BMC will not bear any additional liability towards payment of any Taxes &amp; Duties.</p> <p>Wherever the services to be provided by the Tenderers, falls under Reverse Charge Mechanism, the Price quoted shall be exclusive of GST, but inclusive of Taxes/Duties/Cess other than GST, if any.</p> <p>Rates accepted by BMC shall hold good till completion of work and no additional individual claim shall be admissible on account of fluctuations in market rates; increase in taxes/any other levies / tolls etc. except that payment/recovery for overall market situation shall be made as per Price variation <b>and if there is any subsequent change (after submission of bid) in rate of GST applicable on the work/services to be executed as per tender, i.e. any increase will be reimbursed by BMC whereas any reduction in the rate of GST shall be passed on to BMC as per the provisions of the GST Act.</b></p>	<p>The tenderer shall quote inclusive of all taxes other than GST (<b>Excluding GST</b>), <u>Levies, Duties, Cess etc as applicable at the time of bid submission</u>. GST as applicable shall be paid separately on submission of bills/invoice.</p> <p>Input Tax Credit of GST as available with the bidder will not be claim separately by BMC. However, while quoting the rates benefit of Input Tax Credit or Exemptions shall be passed on to the BMC by way of equivalent reduction in quoted price.</p>

उपरोक्त सुधारीत अट अद्ययावत एकसामायिक दरसूची २०२३ नुसार अंदाजपत्रक तयार करुन मागविण्यात आलेल्या/ येणा-या ई-निविदा/निविदा/दरपत्रक या कामांकरिता लागू असेल.

अतएव, सध्या ज्या ई-निविदा/निविदा/दरपत्रक एकसामायिक दरसूची २०२३ अंतर्भूत करुन मागविलेल्या आहेत अशा निविदांमध्ये नियत दिनांकापूर्वी शुद्धीपत्रकाद्वारे उपरोक्त सुधारीत अट समाविष्ट करण्याबाबत तसेच यापुढे एकसामायिक दरसूची २०२३ अंतर्भूत करुन मागविण्यात येणा-या ई-निविदा/निविदा/दरपत्रक यांमध्ये उपरोक्त सुधारीत अट समाविष्ट करण्याबाबत संबंधित खातेप्रमुख यांनी दक्षता घ्यावी.

सर्व खातेप्रमुख, रूग्णालयांचे अधिष्ठाता, सहायक आयुक्त, यांनी उपरोक्त सुचनांचे काटेकोरपणे अनुपालन करावे.

सही/- २८/०३/२०२३

(पांडुरंग गोसावी)

**प्रमुख लेखापाल (पा.पु.म.नि.)**

सही/- २८/०३/२०२३

(प्रदिप पडवळ)

**प्रमुख लेखापाल (वित्त) प्र.**

सही/- २८/०३/२०२३

(रामदास आव्हाड)

**उप आयुक्त (वित्त)**

सही/- २८/०३/२०२३

(पी. वेलरासू)

**अतिरिक्त आयुक्त (प्रकल्प)**

C-

**BRIHANMUMBAI MUNICIPAL CORPORATION**

**Circular**

No. CA/Finance/Project/19 , Date 04.03.2024

Subject - Revised guidelines for payment of EMD for tenders to be uploaded on Mahatender Portal.

- Ref -
1. MDD/7878, dt.27.09.2016.
  2. Dir./IT/F-59, dt.10.05.2023.
  3. Dir./IT/505038 , dt.19.12.2023

As per the guideline issued vide circular mention in reference no. 2 & 3, all department are directed to use Mahatender for all the tenders above 25 lacs with effect from 15<sup>th</sup> June 2023, and for tenders below 25 lacs with effect from 21<sup>st</sup> December 2023 respectively. Accordingly all departments of BMC shall use e-Procurement System of Government of Maharashtra (Mahatender). Further, it has been directed that, all BMC department will have to follow the standard procedures of the said e-Tendering system of GoM and make relevant changes in their respective tender documents.

For participating in bidding process, bidders are required to deposit Earnest Money Deposit (EMD) through the payment gateways while submitting the bids. In BMC's tenders, in some cases, as per the relevant clause of tender, 10% of EMD amount has to be forfeited. Further, in some cases, for more than 2 curable-defects shortfalls, 2% of EMD per instance is forfeited. However, in Mahatender System, there is no such provision of partial forfeiture of EMD amount. Hence, the existing condition of partial forfeiture of EMD elaborated above needs to be modified. Further, the work of modifying Standard Bid Document of BMC under chairmanship of DMC (Infra) is under progress. Final decision regarding partial forfeiture of EMD will be taken by the committee. However, till then, to streamline the process of bidding, interim instructions regarding EMD are as follows;

C:\Users\3938308\Desktop\100% Online EMD 21.02.2023.docx

1) **Mode of payment of EMD**

A tenderer shall pay entire amount of EMD through payment gateways of GoM on URL <http://mahatenders.gov.in>. The bidder shall upload scan copy of online paid EMD along with the bid submission in packet 'A'.

Any bid not accompanied by an acceptable Bid Security shall be rejected by the Employer as non-responsive.

2) **If non-responsive;**

If the bidder is found non-responsive after scrutiny of packet 'A'/'B', in such circumstances, **the bidder will be made non-responsive and financial packet 'C' of non-responsive bidder will not be opened. However, there will not be any forfeiture of EMD.**

3) **Shortfalls:-**

Maximum 5 shortfalls of curable defects shall be allowed and in case, curable defects are not compiled by bidder within given time period, the bidder shall be treated as 'Non-Responsive' & such cases will be informed to Registration and Monitoring Cell. Such non-submission of documents will be considered as 'Intentional Avoidance' and if three or more cases in 12 months are reported, shall be viewed seriously and disciplinary action against the defaulters such as banning/de-registration, etc. shall be taken by Registration Cell with due approval of the concerned AMC.

4) **Refund of EMD :-**

- c) Except successful bidder all other unsuccessful bidders' 100% EMD paid online will be refunded automatically.
- d) The Bid security of successful bidder will be discharged when the bidder has signed the agreement and /or furnish the required Security Deposits as elaborated in Standard Bid Document.

5) **Forfeiture of Entire EMD:-**

The existing conditions laid down in Standard Bid Document regarding forfeiture of entire bid security (EMD) shall remain unchanged.

These, interim-instructions will remain in force till the issuance of circular regarding amendment in SBD.

All the concerned Assistant Commissioners / HoDs shall note the above directives and to incorporate suitable clause in the draft tenders to be invited hereafter with immediate effect.

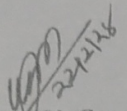
  
(Pandurang V. Gosavi)  
Chief Accountant (W.S.S.D.)

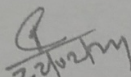
  
(Shri. P. N. Gaikwad)  
D.M.C. (Finance)  
Sir,

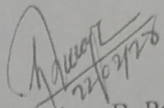
  
(Pradeep B. Padwal)  
Chief Accountant (Finance) i/c

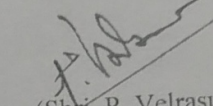
  
(Shri. P. Velrasu)  
A.M.C. (Project)  
Sir,

**PROFORMAS:**

**PROFORMA- I**

The list of similar works as stated in para 'A' of Post qualification during last Seven years-

<b>PROFORMA- I</b>					
Sr. No.	Name of the Project	Name of the employer	Stipulated date of completion	Actual date of completion	Actual Cost of work done
1	2	3	4	5	6

**NOTE:**

- a. Scanned Attested copies of completion/performance certificates from the Engineer-in-Charge for each work should be annexed in the support of information furnished in the above proforma.
- b. Works shall be grouped financial year-wise.



## PROFORMA- II

Yearly Turnover During the Last Three Years.

PROFORMA- II					
Sr.No.	Financial year	Annual Turnover	Updated Value to Current year	Average of last 3 years	Page No.
1					
2					
3					
Total					

**NOTE:**The above figures shall tally with the audited balance sheets uploaded by the tenderer duly certified by Chartered Accountant.

### PROFORMA- III

At least similar work, as stated in para 'A' of Post qualification,

PROFORMA- III							
Name of the Project	Name of the Employer	Cost of the Project	Date of issue of work Order	Stipulated Date of Completion	Actual Date of Completion	Actual cost of work done	Remarks explaining reasons for delay, if any
1	2	3	4	5	6	7	8

**NOTE:** Scanned Attested copies of completion/performance certificates from the Engineer-in-charge for each work should be annexed in support of information furnished in the above proforma.

## PERSONNEL

PROFORMA- IV					
Sr. No.	Post	Name (Prime Candidate / Alternate)	Qualification	Work Experience	
				No. of years	Name of the Project
1					
2					
3					
4					

**NOTE:** Scanned Attested copies of qualification certificates and details of work experience shall be submitted /uploaded.

**MACHINERY: (for Special Work only)**

<b>PROFORMA- V/A</b>			
Sr.No.	Equipment	Number	Owned/Leased/Assured access
1	2	3	4

**PROFORMA- V/B**

<b>PROFORMA- V/B</b>			
Sr.No.	Equipment	Number	Owned
1	2	3	4

**NOTE:** The tenderer(s) shall furnish/upload the requisite Scanned Attested documents of ownership/leased of machineries. The undertaking from the suppliers will not be accepted.

## PROFORMA – VI / A

Details of Existing Commitments and Ongoing Works

PROFORMA- VI / A							
Description of work	Place	Contract No.& Date	Name &Address of employer	Value of Contract in Rs.	Scheduled Date of completion	Value of work remaining to be completed	Anticipated Date of completion
1	2	3	4	5	6	7	8

**NOTE:** Scanned Attested copies of completion/performance certificates from the Engineer-in-Charge for each work should be annexed in the support of information furnished in the above proforma.

## PROFORMA – VI / B

Details of works for which bids are already uploaded –

PROFORMA – VI / B						
Description of Work	Place	Name & Address of employee	Value of Contract in Rs.	Time Period	Date on which decision is expected	Remarks
1	2	3	4	5	6	7

**NOTE:** Scanned Attested copies of certificates from the Engineer-in-charge for each work shall be annexed.

## PROFORMA- VII

Information on Litigation History in which the applicant is involved.

PROFORMA – VII				
Other Party (/Parties)	Employer	Cause of Dispute	Amount involved	Remarks showing Present Status.
1	2	3	4	5

**NOTE:**

1. Scanned Attested copies of completion / performance certificates from the Engineer-in-charge for each work should be annexed and uploaded.
  
2. Litigation History must cover - Any action of blacklisting, debarring, banning, suspension, deregistration and cheating with BMC, State Govt., Central Govt. or any authority under State or Central Govt/Govt, organisation initiated against the company, firm, directors, partners or authorized signatory shall be disclosed for last 5 years from the date of submission of bid. Also, bidder must disclose the litigation history for last 5 years from the date of submission of bid about any action like show cause issued, blacklisting, debarring, banning, suspension, deregistration and cheating with BMC and BMC is party in the litigation against the company, firm, directors, partners or authorized signatory for carrying out any work for BMC by any authority of BMC and the orders passed by the competent authority or by any Court where BMC is a party. While taking decision on litigation history, the concerned Chief Engineer or D.M.C. or Director, as may be the case, should consider the details submitted by bidder and take decision based on the gravity of the litigation and the adverse effect of the act of company, firm, directors, partners or authorized signatory on the BMC works which can spoil the quality, output, delivery of any goods or any work execution and within the timeframe.

**PROFORMA VIII**

**Memorandum of Understanding between Manufacturer & Authorised Representative**

(On stamp paper of Rs. 500/- duly notarized to be submitted in Packet 'B' as per Bidding Schedule)

Sub :- .....  
.....

Bid Invitation No. :- .....

Deed for the MEMORANDUM OF UNDERSTANDING is made and entered into at \_\_\_\_\_ on \_\_\_\_\_ Between M/s. \_\_\_\_\_, manufacturer of \_\_\_\_\_ having registered office at \_\_\_\_\_ hereinafter called as **'MANUFACTURER'**

**AND**

M/s. \_\_\_\_\_ **AUTHORISED REPRESENTATIVE** of above manufacturer having their registered office at \_\_\_\_\_ hereinafter called as **'AUTHORISED REPRESENTATIVE'**

It is hereby agreed by both manufacturer and their authorised dealer that:

1. Above manufacturer and authorised representative are jointly interested in participation in above subject tender on following individual roles and responsibilities.
2. The roles and responsibilities of the manufacturer regarding \_\_\_\_\_ in the said bid are-  
\_\_\_\_\_  
\_\_\_\_\_

***(Here Manufacturer shall mention their detailed roles and responsibility)***

3. The roles and responsibilities of the authorized representative regarding \_\_\_\_\_ in the said bid are-

\_\_\_\_\_  
\_\_\_\_\_

***(Here Authorised Representative shall mention their detailed roles and responsibility)***

4. The manufacturer undertakes to make uninterrupted supply of \_\_\_\_\_ for the said project as per the schedule of the work and to provide all necessary technical support.

5. In case Manufacturer / authorised representative fails to execute their obligation and responsibility as mentioned above or anywhere in the tender, BMChave right to blacklist the manufacturer / authorised representative for non-performance.

Authorised Signatory & Seal Authorised Signatory & Seal

On behalf of the Manufacturer On behalf of the Authorised Representative

Witness :

1) \_\_\_\_\_

2) \_\_\_\_\_

3) \_\_\_\_\_

4) \_\_\_\_\_



**SECTION 16**  
**EXISTING SITE PLAN**

EXISTING SITE PLAN

EXISTING UTILITIES OF MaladWWTF

