



BRIHANMUMBAI MUNICIPAL CORPORATION

DRAFT BID DOCUMENT

E-TENDER

FOR

E- Tender No. - 7200037494

**Name of Work:-ES - 435 Training and Widening of Laxmibaug
nalla at Sidhrameshwar Nagar, Ghatkopar(E) in N Ward.**

Website: [www. portal.mcgm.gov.in/tenders](http://www.portal.mcgm.gov.in/tenders)

Office of: Office of the

Dy. Chief Engineer (SWD)

Eastern suburbs, 5th floor,

Parivar Building, CTS No 119/B

of village, Kanjur (East) Mumbai 400042

INDEX

SECTION	DESCRIPTON	Page No.
1	e-TENDER NOTICE	4
2	ELIGIBILITY CRITERIA	10
3	DISCLAIMER	15
4	INTRODUCTION	18
5	e-TENDER ONLINE SUBMISSION PROCESS	22
6	INSTRUCTIONS TO APPLICANTS	26
7	SCOPE OF WORK	55
8	BILL OF QUANTITIES	58
9	GENERAL CONDITONS OF CONTRACT	68
10	SPECIFICATIONS	122
11	FRAUD AND CORRUPT PRACTICES	125
12	PRE-BID MEETING	129
13	LIST OF APPROVED BANKS	131
14	APPENDIX	135
15	SPECIAL DIRECTIONS TO TENDERER	185
16	LIST OF WORKS	209
17	LOCATION PLAN	211
18	TYPICAL DRAWINGS	213

19	Reference Circulars	215
20	FINANCIAL BID FORM (FORM-B)	240

SECTION 1
E-TENDER NOTICE

BRIHANMUMBAI MUNICIPAL CORPORATION

Office of
Deputy Chief Engineer (Storm Water Drains)E.S.
No. Dy.Ch.E./8672/SWD/ ES dt. 11.10.2022

SHORT PERIOD E-TENDER NOTICE

(Bid No -7200037494)

Subject: -ES - 435 Reconstruction of retaining wall of Laxmibaug nalla at Sidhameshwar Nagar Ghatkopar (East) in N ward., Ghatkopar(E) in N Ward.

The Brihanmumbai Municipal Corporation (BMC) invites e-tender to appoint Contractor for the aforementioned work from contractors of repute, multidisciplinary Engineering organizations i.e. eminent firm, Proprietary/Partnership Firms/ Private Limited Companies/ Public Limited Companies/Companies registered under the Indian companies' Act 2013, the contractors registered with the Brihanmumbai Municipal Corporation, **(BMC) inClass II as per new registration Rules** (excluding those who are blacklisted or against whom FIR have been filed) or those having equivalent **or more work experience** from Central or State Government/Semi Govt. Organization/Central or State Public Sector Undertakings works will be allowed subject to condition that, the contractors who are not registered with BMC will have to apply for registering their firm within three months time period from the date of issue of work order, otherwise their Bid Security i.e. E.M.D (Earnest Money Deposit) will be forfeited/recovered and a penalty of 0.1% of contract cost or Rs. 10,000/- whichever is more will be recovered / deducted from the contractors payment / bill by the executing department. Bidding Process will comprise of three stages. **(Please refer circular Dir. / ES & P / 1078 / MC dt. 30.11.2018).**

The application form can be downloaded from BMC's portal (<http://portal.mcgm.gov.in>) on payment of **Rs. 10,400 + GST.** The applicants not registered with BMC are mandated to get registered (Vendor Registration) with BMC for e-tendering process & obtain login credentials to participate in the online bidding process.

- i) To download the application form, for those applicants not having vendor registration, need to apply first for vendor registration at the office of Account Officer (FAR), 3rd floor, Municipal Headquarter.

- ii) Followed by SRM login ID and password to be obtained from Central Purchase Department (CPD), Office at Byculla, Bakariadda, Mumbai.
- iii) For e-Tendering registration, enrollment for digital signature certificates and user manual, please refer to respective links provided in 'Tenders' tab. Vendors can get digital signature from any one of the Certifying Authorities (CA's) licensed by controller of certifying authorities namely, Safes crypt, IDRBT, National informatics center, TCS,CUSTOMS, MTNL, GNFC and e-Mudhra CA.

Name and Location of Work	Contract Period	Estimated Cost of Project
<p>e-tender no.:-<u>7200037494</u>)</p> <p>ES - 435 Training and Widening of Laxmibaug nalla at Sidhrameshwar Nagar, Ghatkopar (E) in N Ward.</p>	<p>6Months (Ex. Monsoon)</p>	<p>Rs. 6,21,13,614.00/-</p>

In terms of the 3 stage system of e-tendering, a Bidder will be required to deposit, along with its Bid, an Earnest Money Deposit of **Rs. 6,21,140.00/-(Rupees Six lakh Twenty one Thousand And one Hundred Forty only)**(the "EMD"), refundable in accordance to the relevant clause of bid document, from the Bid Due Date, except in the case of the selected Bidder whose Bid Security/EMD shall be retained. The Bidders will have to provide Earnest Money Deposit through the payment gateways while submitting the bids. The Bid shall be summarily rejected if it is not accompanied by the Earnest Money Deposit. The e-tender is available on BMCportal ([http:// portal.mcgm.gov.in](http://portal.mcgm.gov.in)) as mentioned in the Header Data of the tender.

As per THREE Packet systems, the document for PacketA&B is to be uploaded by the bidder in vendors' document online in Packet A, B. Packet A, B& C shall be opened on dates as mentioned in header data. All the prospective bidders shall be present at the time of opening of bids, in the office of Dy. Chief Engineer (SWD) Eastern suburbs, 5th floor, Parivar Building, CTS No 119/B of village, Kanjur (East) Mumbai 400042. The Packet C shall be opened if bids submission in Packet A& B satisfies/includes all the requirements and same are found acceptable to the Authority.

The Municipal Commissioner reserves the right to reject all or any of the e- tender(s) without assigning any reasons at any stage.

The dates and time for submission and opening the bids are as shown in the Header Data. If there are any changes in the dates the same will be displayed on the BMCPortal. ([http:// portal.mcgm.gov.in](http://portal.mcgm.gov.in))

The Applicants interested for the above referred works may contact the Dy. Chief Engineer (S.W.D.) E.S. at the following address on any working day during office hours.

**Office of:Office of the Dy. Chief Engineer (SWD) Eastern suburbs, 5th floor,
Parivar Building, CTS No 119/B of village, Kanjur (East) Mumbai 400042**

The BMCreserves the rights to accept any of the application or reject any or all the application received for above works, without assigning any reasons thereof. The information regarding above subject matter is available on Website of BMC. ([http:// portal.mcgm.gov.in/tenders](http://portal.mcgm.gov.in/tenders)).

Sd/-

Dy. Chief Engineer (S.W.D.) E.S.

HEADER DATA

Tender Document No.	7200037494
Name of Organization	Brihanmumbai Municipal Corporation
Subject	ES –435 Training and Widening of Laxmibaug nalla at Sidhrameshwar Nagar, Ghatkopar(E) in N Ward. (Brimstowad work).
Cost of Tender	Rs. 10,400 + GST
Cost of E-Tender (Estimated Cost)	Rs.6,21,13,614.00/-
Bid Security Deposit/EMD	Rs. 6,21,140.00/-
Date of Issue and sale of Tender	14.10.2022 from 10:00 Hrs.
Pre-Bid Meeting	Not Applicable
Last date & time for sale of tender	17.10.2022 up to 15.00 Hrs
Submission of Packet A, B & Packet C (Online) and Receipt of Bid Security Deposit/EMD	17.10.2022 up to 16.00 Hrs in Office of Dy.Ch.E(SWD) E.S.
Opening of Packet A	17.10.2022 after 16.01 Hrs in Office of Dy.Ch.E(SWD) E.S.
Opening of Packet B	17.10.2022 after 16.10 Hrs in Office of Dy.Ch.E(SWD) E.S.
Submission date of Physical D.D. / NIL report towards ASDAs per tender condition and rate analysis documents in case of rebate or premium of 15% & above if quoted by bidder	19.10.2022 before 15.00 Hrs in Office of Dy.Ch.E(SWD) ES.
Opening of Packet C	19.10.2022 after 15.01 Hrs in Office of Dy.Ch.E(SWD) E.S
Address for Communication	Office of the : Dy. Chief Engineer (SWD), Eastern suburbs, 5th floor, Parivar Building, CTS No 119/B of village, Kanjur (East) Mumbai 400042, Contact No -8355902092.
Contact person	AE Shri S.M.Kulkarni (9892777424) of N ward Email :- ee01es.swd@mcgm.gov.in
Venue for opening of Bid	Online in Dy.Chief Eng.(SWD)E.S.'s office.

Note:-

- a) It is a short notice tender due to emergency. Bidders shall remain present during opening of Packet A and Packet B so that shortfalls if any may be complied at earliest please.

- b) The header data mentioned in this tender notice or in corrigendum if any issued on MCGM web site on Portal will be treated as final.
- c) Shortfalls if any observed in scrutiny of documents submitted by the bidders in Packet 'A' and 'B' will be displayed on notice board of office of Dy. Ch. E. (SWD) ES on Same day of opening Packet 'A' and 'B'. bidder shall take a note of the same and shall submit compliance on same day please.
- d) Rate Analysis In case of rebate/premium of 15% and above as quoted by the tenderer in prescribed format shall be submitted one day before opening of Packet 'C' before 5.00pm in seal Envelope to the respective Head Clerk (Expenditure) of S.W.D Division, failing which 10% EMD will be forfeited.
If rate analysis submitted by bidder is found unjustified, offer will be treated as non responsive and 10% EMD will be forfeited.

This tender document is not transferable.

The BMC reserves the rights to accept any of the application or reject any or all the application received for above subject without assigning any reason thereof.

Sd/-

Dy.Ch.Eng.(SWD)E.S.

SECTION 2
ELIGIBILITY CRITERIA

For Regular, Routine and Maintenance works:

1. Repairs, Augmentation and rehabilitation of SWD system.
2. Rehabilitation of culverts on major and minor roads
3. Repairs to Major & Minor nallas,
4. Remodeling of SWD system,
5. Repairs to roadside drains,
6. Training & Widening of major and minor drains /nallas,
7. Reconstruction of collapsed walls.
8. New R.C.C.box culverts across minor or major roads,
9. Desilting of Major & Minor nallas.
10. Remodeling, enlargement and construction of culverts/small bridges upto 6.0 m span.
11. Repairs to existing SWD pumping stations
12. Construction of parapet wall.

1.1 Technical Capacity

The tenderer(s) in their own name should have satisfactorily executed the work of similar nature BMC/Semi Govt. /Govt. & Public Sector Organizations during **last seven (7) years** ending last day of month previous to the one in which bids are invited as a prime Contractor (or as a nominated sub-Contractor, where the subcontract had involved similar nature of work as described in the scope of works in this bid document, provided further that all other qualification criteria are satisfied)

a) **Three similar completed** works each of value not less than the value equal to **20%** of estimated cost put to tender

OR

b) **Two similar completed** works **each** of value not less than the value equal to **25%** of estimated cost put totender

OR

c) **One similar completed** work of value equal and or not less than the **40%** of estimated cost put totender.

The value of executed completed works shall be brought to current costing level by enhancing the actual value of work at compound rate of 10 % per annum; calculated from the date of completion to last date of receipt of applications for tenders.

1.2 Financial Capacity

Achieved an average annual financial turnover as certified by 'Chartered Accountant' (in all classes of civil Engineering construction works only) equal to **30%** of the estimated cost of work in last three (3) financial years immediately preceding the Financial Year in which bids are invited.

The value of executed completed works shall be brought to current costing level by enhancing the actual value of work at compound rate of **10 %** per annum; calculated from the date of completion to last date of receipt of applications for tenders.

1.3 Similar Experience :-

For assessing the technical capacity of Regular, Routine and Maintenance works; Similar work shall mean, the completed ~~or ongoing~~ works in Building Construction OR Building Maintenance **OR Bridge department** such as repairs/retrofitting /structural repairs OR construction/repairs of Asphalt/ Concrete roads OR laying/rehabilitation of sewer lines along with allied components OR laying/rehabilitation of water pipe lines in Cast Iron/ M.S. pipes / HDPE/ MDPE pipes OR repairs/maintenance/ construction of culvert/overallah / nallah's / box drains.

2. For Original and New Construction Works :-

- a) ~~New SWD Pumping Stations & additional works, if any~~
- b) ~~Construction of nallas at outfalls near creeks/sea.~~
- c) ~~Construction of new pipe/RCC box drain with Micro Tunneling methodology or any other special methodology as per site conditions.~~

2.1 Technical Capacity :-

~~The tenderer(s) in their own name should have satisfactorily executed the work of similar nature BMC/Semi Govt. /Govt. & Public Sector Organizations during last **seven (7) years** ending last day of month previous to the one in which bids are invited as a prime Contractor (or as a nominated sub-Contractor, where the subcontract had involved similar nature of work as described in the scope of works~~

~~in this bid document, provided further that all other qualification criteria are satisfied)~~

- ~~a) Three similar completed works or currently executing three works of similar nature each costing 30% of estimated cost.*~~

~~OR~~

- ~~b) Two similar completed works or currently executing two works of similar nature each costing 40% of estimated cost.*~~

~~OR~~

- ~~e) One completed work or currently executing one work of similar nature of aggregate 60% of estimated cost.*~~

~~— The value of executed completed works shall be brought to current costing level by enhancing to actual value of work at compound rate of 10 % per annum; calculated from the date of completion to last date of receipt of applications for tenders.~~

~~*In case of ongoing works to be considered, the bidder must have received payment bills of 80% of the contract sum for the work/works executed last day of month previous to the one in which bids are invited.~~

2.2 Financial Capacity

~~Achieved a average annual financial turnover as certified by 'Chartered Accountant' (in all classes of civil Engineering construction works only) equal to 30% of the estimated cost of work in last three (3) financial years immediately preceding the Financial Year in which bids are invited.~~

- ~~• To ascertain this, tenderer(s) shall furnish /upload the financial statement (Audited balance sheet) duly certified by Chartered Accountant.~~
- ~~• The turnover can be enhanced by 10% every year to bring the present level.~~

2.3 Similar experience is spelt in definite sense, such as-

~~Similar Experience for the following works as required for the~~

tendered work

- a) ~~Construction of any type of Pumping Stations & ancillary works.~~
- b) ~~Any type of construction works in creek/sea.~~
- c) ~~Any type of construction works with Micro Tunneling methodology or any other special methodology as may be specified in the Tender.~~

3. **Bid Capacity:**

The bid capacity of the prospective bidders will be calculated as under:

Assessed Available Bid Capacity = (A* N* 2 - B)

Where,

A = Maximum value of Civil Engineering works executed in any one year (year means Financial year) during the last five years (updated to the price level of the Financial year in which bids are received at a rate of 10% per year) taking into account the completed as well as works in progress.

N = Number of years prescribed for completion of the Project/Works, **excluding monsoon** period, for which these bids are being invited. (E.g. 7 months = 7/12 year) For every intervening monsoon 0.33 shall be added to N.

B = Value of existing commitments (only allotted works) on the last date of submission of bids as per bidding document and on-going works to be completed during the period of completion of the Project/Works for which these bids are being invited.

Note:1) The statement showing the value of existing commitments and on-going works as well as the stipulated period of completion remaining for each of the works listed should be attached along with certificates duly signed by the Engineer-in Charge, not below the rank of an Executive Engineer or equivalent.

2)For calculation of Bid Capacity, **N=1** for this tender.

Even though the bidders meet the above qualifying criteria, they are subject to be disqualified if they have:

- made misleading or false representation in the forms, statements and attachments submitted in proof of the qualification requirements; and/or
- Record for poor performance such as abandoning the works, not properly completing the contract, inordinate delays in completion, ~~litigation history~~, or financial failures etc. (Please see circular MGC / F / 6565 dt. 25.09.2018).

SECTION 3
DISCLAIMER

DISCLAIMER

The information contained in this e-tender document or provided to Applicant(s), whether verbally or in documentary or any other form, by or on behalf of the Brihanmumbai Municipal Corporation (BMC), hereafter also referred as "The Authority ", or any of its employees or advisors, is provided to Applicant(s) on the terms and conditions set out in this e-tender and such other terms and conditions subject to which such information is provided.

This e-tender includes statements, which reflect various assumptions and assessments arrived at by the Brihanmumbai Municipal Corporation (BMC) in relation to the Project. Such assumptions, assessments and statements do not purport to contain all the information that each Applicant may require. This e-tender may not be appropriate for all persons, and it is not possible for the Brihanmumbai Municipal Corporation (BMC), its employees or advisors to consider the investment objectives, financial situation and particular needs of each party who reads or uses this e-tender. The assumptions, assessments, statements and information contained in this e-tender may not be complete, accurate, adequate or correct. Each Applicant should therefore, conduct its own investigations and analysis and should check the accuracy, adequacy, correctness, reliability and completeness of the assumptions, assessments, statements and information contained in this e-tender and obtain independent advice from appropriate sources.

Information provided in this e-tender to the Applicant(s) is on a wide range of matters, some of which may depend upon interpretation of law. The information given is not intended to be an exhaustive account of statutory requirements and should not be regarded as a complete or authoritative statement of law. The Brihanmumbai Municipal Corporation (BMC) accepts no responsibility for the accuracy or otherwise for any interpretation or opinion on law expressed here.

The Brihanmumbai Municipal Corporation (BMC), its employees and advisors make no representation or warranty and shall have no liability to any person, including any Applicant or Bidder, under any law, statute, rules or regulations or tort, principles of restitution or unjust enrichment or otherwise for any loss, damages, cost or expense which may arise from or be incurred or suffered on account of anything contained in this e-tender or otherwise, including the accuracy, adequacy, correctness, completeness or reliability of the e-tender and any assessment, assumption, statement or information contained therein or deemed to form part of this e-tender or arising in any way with pre-qualification of Applicants for participation in the Bidding Process. The Brihanmumbai Municipal Corporation (BMC) also accepts no liability of any nature whether resulting from negligence or otherwise howsoever caused arising from reliance of any Applicant upon the statements contained in this e-tender.

The Brihanmumbai Municipal Corporation (BMC) may, in its absolute discretion but without being under any obligation to do so, update, amend or supplement the information, assessment or assumptions contained in this e-tender.

The issue of this e-tender does not imply that the Brihanmumbai Municipal Corporation (BMC) is bound to select and short-list pre-qualified Applications for Bid Stage or to appoint the selected Bidder or Concessionaire, as the case may be, for the Project and the Brihanmumbai Municipal Corporation (BMC) reserves the right to reject all or any of the Applications or Bids without assigning any reasons whatsoever.

The Applicant shall bear all its costs associated with or relating to the preparation and submission of its Application including but not limited to preparation, copying, postage, delivery fees, expenses associated with any demonstrations or presentations which may be required by The Brihanmumbai Municipal Corporation (BMC) or any other costs incurred in connection with or relating to its Application. All such costs and expenses will remain with the Applicant and the Brihanmumbai Municipal Corporation (BMC) shall not be liable in any manner whatsoever for the same or for any other costs or other expenses incurred by an Applicant in preparation or submission of the Application, regardless of the conduct or outcome of the Bidding Process.

SECTION 4
INTRODUCTION

INTRODUCTION

1. Background:

The Brihanmumbai Municipal Corporation (BMC) covers an area of 437.71 sq.kms. with a population of 1.24 Crores as per census of 2011. The metropolis accounts major portion of India's international trade and government's revenue, from being one of the foremost centers of education, science and technological research and advancement.

The Mumbai Metropolis has historic tradition of strong civic activism dedicated to the cause of a better life for all its citizens. And it's the Brihanmumbai Municipal Corporation (BMC), hereafter called the "corporation", the primary agency responsible for urban governance in Greater Mumbai.

BMC (The Authority) is one of the largest local self-governments in the Asian Continent. In observance of historic traditions of strong civic activism, with the change in time and living conditions to match with the urbanization, BMC has mainly focused in providing almost all kinds of Engineering services viz, Hydraulics, storm water drain, sewerage, water supply projects, roads, bridges, solid waste management, and environmental services. Beside this, the BMC is also providing dedicated services in various segments such as Health, Primary Education as well as the construction and maintenance of Public Markets and Slaughter Houses.

BMC is an organization having different departments, right from Engineering depts. to health depts. Moreover we have other dept. like education, market, fire brigade dept., Octroi and other such departments where quite a good number of staff members are working.

Scope of Work:

ES - 435 Training and Widening of Laxmibaug nalla at Sidhrameshwar Nagar, Ghatkopar (E) in N Ward.

Any other Nalla works/ SWD wall and culverts in N ward not included in BOQ in addition to proposed work and in place of proposed work, as directed by Engr.-in-Charge.

2) The Major Components of this work are:-

- Construction of R.C.C. Box drain.
- Construction of road side drain in R.C.C. walls with R.C.C. slab/ covering.
- All SWD /Nalla walls to be constructed in RCC.
- Box Drains, Culvert raft / walls / slab / Pile work to be constructed in R.C.C. / having a grade of concrete M-15 / M-20 / M-25 / M-40.

- Reinstatement of approach road abutting to box drain/Culvert.
- Thermo-Mechanically Treated steel bars / CRS bars. (Fe 500 D) to be used in R.C.C.
- Construction of Footpath as per BMCpolicy/circular if any.
- All types of concrete works will be carried out in RMC.
- Repair/ Construction of Collapsed walls/Improvement of minor/major nalla in the vicinity within scope, if required as per instructions of Engineer- In -Charge.
- Contractor have to make arrangement for own dumping plot.
- Any unforeseen work if arises related to catchment area (ongoing work) is to be attended by appointed contractual agency.
- The trees affected in the alignment of SWD and Pathway shall be removed by obtaining permission from tree authority. The successful tenderer(s) has to deposit the requisite amount with Tree authority for faithful compliance of permission from Tree Authority.
- Desilting of existing SWD/nalla throughout the contract period at risk and cost of tenderer(s). No payment to the contractor will be made on this account.
- To carry out total station survey and submit to the office of Dy.Ch.Eng. (SWD)ES before starting of the work.
- To submit the structural design of all works before starting of works and get it approved from competent authority.
- The contractor is to make all necessary arrangements for utility shifting, diversion of flow for enlarging the construction, dewatering, utility diversion. The contractor shall quote the tender keeping these points in mind. The contractor should take into account and make necessary arrangement for the safety of adjoining structure.
- Tenderer shall obtain NOC before commencement of work from SWM department towards C & D waste generated during execution of work in accordance with the provisions of Construction and Demolition Waste Management Rules 2016 and in consonance with the circular issued under no. Dy.Ch.Eng./SWD/3957/Op dt. 28.09.2018.

Estimated cost of the work : - As per the Tender notice.

Note:-

- (i) All the works contained in the scope of work shall be carried out strictly as per relevant specifications applicable as attached or referred to, in this tender document.
- (ii) The above is general description of the scope of work and actual work mentioned above shall be governed by B.O.Q. and as directed by the Engineer-in-Charge.
- (iii) Applicable schedules.:- Unified schedule of rates for S.W.D., Building construction, Road works, Bridge works, Hydraulic Engineering, Sewerage Projects etc. effective from 20.06.2018.

SECTION 5
E-TENDERING ONLINE
SUBMISSION PROCESS

E-TENDERING ONLINE SUBMISSION PROCESS

The terminology of e-Tendering is solely depending upon policies in existence, guidelines and methodology adopted since decades. The SRM is only change in process of accepting and evaluation of tenders in addition to manual. The SAP module to be used in this E-tendering is known as Supplier Relationship Module (SRM).SRM is designed and introduced by ABM Knowledge ware Ltd. who will assist BMCin throughout the tendering process for successful implementation.

NOTE: This tendering process is covered under Information Technology ACT & Cyber Laws as applicable

(1) In e-tendering process some of the terms and its definitions are to be read as under wherever it reflects in online tendering process.

Start Date read as “Sale Date”

End Date read as “Submission Date”

Supplier read as “Contractor/bidder”

Vendor read as “Contractor/bidder”

Vendor Quotation read as “Contractors Bid/Offer”

Purchaser read as “Department/BMC”

- I. Before entering in to online tendering process, the contractors should complete the registration process so as to get User ID for E-tendering links. For this, the contractors can access through Supplier registration via BMCPortal.

There are two methods for this registration :(II and III)

- II. Transfer from R3 (registered contractors with BMC) to SRM
 - a) Contractors already registered with BMCwill approach to Vendor Transfer cell.
 - b) Submit his details such as (name, vendor code, address, registered Email ID, pan card etc.) to Vendor transfer cell.
 - c) BMCauthority for Vendor Transfer, transfers the Vendor to SRM application from R3 system to SRM system.
 - d) Transferred Vendor receives User ID creation link on his supplied mail Id.

- e) Vendor creates his User ID and Password for e-tendering applications by accessing link sent to his mail ID.
- III. Online Self Registration (Temporary registration for applicant not registered with BMC)
- a) Vendor fills up Self Registration form via accessing BMCportal.
 - b) Vendor Transfer cell (same as mentioned above) accesses Supplier Registration system and accepts the Vendor request.
 - c) Accepted Vendor receives User ID creation email with Link on his supplied mail Id.
 - d) Vendor creates his User ID and Password for e-tendering application.
- IV. CONTRACTORS BIDDING: Applicant will Quote and Upload Tender Documents:
- 1) Access e-tender link of SRM Portal
 - 2) Log in with User ID and Password
 - 3) Selects desired Bid Invitation (he wants to bid)
 - 4) To download tender documents contractors will have to pay online Tender fee. The same can be done by accessing Pay Tender Fees option. By this one will be able to pay Tender fee through Payment Gateway-If transaction successful, Contractors can register his interest to participate. Without Registration one cannot quote for the Bid/Tender.
 - 5) Applicant will download Tender Documents from Information from purchaser tab by accessing Purchaser document folder through collaboration 'C' folder link.
 - 6) Applicant will upload Packet A related and Packet B related Documents in Packet A and Packet B folder respectively by accessing these folders through "My Notes" Tab and collaboration folder link.
 - 7) All the documents uploaded have to be digitally signed and saved. Contractors can procure there digital signature from any certified CA's in India.
 - 8) Bid security deposit/EMD and ASD, if applicable, should be paid online as mentioned in tender.

- 9) For commercial details (in Packet C) contractors will fill data in Item Data tab in Service Line Item via details and quotes his "Percentage Variation" (i.e.% quoted) figure.(If entered '0' it will be treated as at par. By default the value is zero only.
- 10)Applicants to check the bid, digitally signs & save and submit his Bid Invitation.
- 11)Applicants can also save his uploaded documents/commercial information without submitting the BID for future editing through 'HOLD' option.
- 12)Please note that "Hold" action do not submit the Bid.
- 13)Applicants will receive confirmation once the Bid is submitted.
- 14)Bid creator (BMC) starts Bid Opening for Packet A after reaching End Date and Time and Bid Evaluation process starts.

As per Three Packet system, the document for Packet A& B are to be uploaded by the tenderer in 'Vendor's document' online in Packet A & B. Before purchasing/downloading the tender copy, tenderer may refer to post- Qualification criteria mentioned in e-Tender Notice.

The tenderer shall pay the EMD/Bid Security through payment gateways before submission of Bid and shall upload the screenshot of receipt of payment in Packet 'A' instead of paying the EMD at any of the CFC centers in BMCWard Offices.

The e-tender is available on BMCportal, [http:// portal.mcgm.gov.in](http://portal.mcgm.gov.in), as mentioned in the Header Data of the tender. The tenders duly filled in should be uploaded and submitted online on or before the end date of submission. The Packet 'A', Packet 'B' & Packet 'C' of the tenderer will be opened as per the time-table shown in the Header Data in the office of **Dy.Ch. Eng.(S.W.D.) E.S.** The Municipal Commissioner reserves the right to reject all or any of the e-Tender(s) without assigning any reason at any stage. The dates and time for submission and opening the tenders are as shown in the Header Data. If there are any changes in the dates the same will be displayed on the BMCPortal ([http:// portal.mcgm.gov.in](http://portal.mcgm.gov.in)).

SECTION 6
INSTRUCTIONS TO
APPLICANTS

INSTRUCTIONS TO APPLICANTS

➤ **Scope of Application**

The Authority wishes to receive Applications for Qualification in order to SELECT experienced and capable Applicants for the Bid Stage.

➤ **Eligibility of Applicants**

- The Brihanmumbai Municipal Corporation (BMC) invites e-tender to appoint Contractor for the afore mentioned work from contractors of repute, multidisciplinary Engineering organizations i.e. eminent firm, Proprietary / Partnership Firms / Private Limited Companies / Public Limited Companies / Companies registered under the Indian companies' Act 2013, the contractors registered with the Brihanmumbai Municipal Corporation (BMC) **in Class II as per new registration Rules** (excluding those who are blacklisted or against whom FIR have been filed) or those having equivalent **or more work experience** from Central or State Government / Semi Govt. Organization / Central or State Public Sector Undertakings works will be allowed subject to condition that, the contractors who are not registered with BMC will have to apply for registering their firm within three months time period from the date of issue of work order, otherwise their Bid Security i.e. E.M.D (Earnest Money Deposit) will be forfeited / recovered and a penalty of 0.1% of contract cost or Rs. 10,000/- whichever is more will be recovered / deducted from the contractors payment / bill by the executing department. Bidding Process will comprise of three stages. (Please refer circular Dir. / ES & P / 1078 / MC dt. 30.11.2018).

To be eligible for pre-qualification and short-listing, an Applicant shall fulfill the following conditions of eligibility:

1. **For Regular, Routine and Maintenance works:**

1. Repairs, Augmentation and rehabilitation of SWD system.
2. Rehabilitation of culverts on major and minor roads
3. Repairs to Major & Minor nallas,
4. Remodeling of SWD system,
5. Repairs to roadside drains,
6. Training & Widening of major and minor drains /nallas,
7. Reconstruction of collapsed walls.
8. New R.C.C.box culverts across minor or major roads,
9. Desilting of Major & Minor nallas.

10. Remodeling, enlargement and construction of culverts/small bridges up to 6.0 m span.
11. Repairs to existing SWD pumping stations.
12. Construction of parapet wall.

1.1 Technical Capacity

The tenderer(s) in their own name should have satisfactorily executed the work of similar nature BMC/Semi Govt. /Govt. & Public Sector Organizations during **last seven (7) years** ending last day of month previous to the one in which bids are invited as a prime Contractor (or as a nominated sub-Contractor, where the subcontract had involved similar nature of work as described in the scope of works in this bid document, provided further that all other qualification criteria are satisfied)

- a) **Three** similar **completed** works each of value not less than the value equal to **20%** of estimated cost put to tender
OR
- b) **Two** similar **completed** works **each** of value not less than the value equal to **25%** of estimated cost put totender
OR
- c) **One** similar **completed** work of value equal and or not less than the **40%** of estimated cost put totender.

The value of completed works shall be brought to current costing level by enhancing the actual value of work at compound rate of 10 % per annum; calculated from the date of completion to last date of receipt of applications fortenders.

1.2 Financial Capacity

Achieved an average annual financial turnover as certified by 'Chartered Accountant' (in all classes of civil Engineering construction works only) equal to **30%** of the estimated cost of work in **last three (3) financial years** immediately preceding the Financial Year in which bids are invited.

The value of completed works shall be brought to current costing level by enhancing the actual value of work at compound rate of 10 % per annum; calculated from the date of completion to last date of receipt of applications for tenders.

1.3 Similar Experience :

For assessing the technical capacity of Regular, Routine and Maintenance works; Similar work shall mean, the completed or ~~ongoing~~ works in Building Construction OR Building Maintenance **OR Bridge Department** such as repairs/retrofitting /structural repairs OR construction/repairs of Asphalt/ Concrete roads OR laying/rehabilitation of sewer lines along with allied components OR laying/rehabilitation of water pipe lines in Cast Iron/ M.S. pipes / HDPE/ MDPE pipes OR repairs/maintenance/ construction of culverts over nallah / nallah's / box drains.

2. For Original and New Construction Works :

- ~~1. New SWD Pumping Stations & additional works, if any~~
- ~~2. Construction of nallas at outfalls near creeks/sea.~~
- ~~3. Construction of new pipe/RCC box drain with Micro Tunneling methodology or any other special methodology as per site conditions.~~

2.1 Technical Capacity :

~~The tenderer(s) in their own name should have satisfactorily executed the work of similar nature BMC/Semi Govt. /Govt. & Public Sector Organizations during last **seven (7) years** ending last day of month previous to the one in which bids are invited as a prime Contractor (or as a nominated sub Contractor, where the subcontract had involved similar nature of work as described in the scope of works in this bid document, provided further that all other qualification criteria are satisfied)~~

- ~~d) **Three similar completed works or currently executing three works of similar nature each costing 30% of estimated cost.***~~
OR
- ~~e) **Two similar completed works or currently executing two works of similar nature each costing 40% of estimated cost.***~~
OR
- ~~f) **One completed work or currently executing one work of similar nature of aggregate 60% of estimated cost.***~~

~~The value of completed works shall be brought to current costing level by enhancing to actual value of work at compound rate of 10 % per annum; calculated from the date of completion to last date of receipt of applications for tenders.~~

~~*In case of ongoing works to be considered, the bidder must have received payment bills of 80% of the contract sum for the work/works executed last day of month previous to the one in which bids are invited.~~

2.2 Financial Capacity

~~Achieved a average annual financial turnover as certified by 'Chartered Accountant' (in all classes of civil Engineering construction works only) equal to **30%** of the estimated cost of work in **last three (3) financial years** immediately preceding the Financial Year in which bids are invited.~~

- ~~• To ascertain this, tenderer(s) shall furnish /upload the financial statement (Audited balance sheet) duly certified by Chartered Accountant.~~
- ~~• The turnover can be enhanced by 10% every year to bring the present level.~~

2.3 Similar experience is spelt in definite sense, such as-

Similar Experience for the following works as required for the tendered work

- ~~a) Construction of any type of Pumping Stations & ancillary works.~~
- ~~b) Any type of construction works in creek/sea.~~
- ~~c) Any type of construction works with Micro Tunneling methodology or any other special methodology as may be specified in the Tender.~~

3. Bid Capacity:

The bid capacity of the prospective bidders will be calculated as under:

Assessed Available Bid Capacity = (A* N* 2 - B)

Where,

A = Maximum value of Civil Engineering works executed in any one year (year means Financial year) during the last five years (updated to the price level of the Financial year in which bids are received at a rate of 10% per year) taking into account the completed as well as works in progress.

N = Number of years prescribed for completion of the Project/Works, **excluding monsoon** period, for which these bids are being invited. (E.g. 7 months = 7/12 year) For every intervening monsoon 0.33 shall be added to N.

B = Value of existing commitments (only allotted works) on the last date of submission of bids as per bidding document and on-going works to be completed during the period of completion of the Project/Works for which these bids are being invited.

Note: 1) The statement showing the value of existing commitments and on-going works as well as the stipulated period of completion remaining for each of the works listed should be attached along with certificates duly signed by the Engineer-in Charge, not below the rank of an Executive Engineer or equivalent.

2) For calculation of Bid Capacity, **N=1** for this tender.

Even though the bidders meet the above qualifying criteria, they are subject to be disqualified if they have:

- made misleading or false representation in the forms, statements and attachments submitted in proof of the qualification requirements; and/or
- Record for poor performance such as abandoning the works, not properly completing the contract, inordinate delays in completion, litigation history, or financial failures etc. (please see circular MGC / F / 6565 dt. 25.09.2018).

D) Equipment Capabilities as required for this work

- a) **Regular and Routine works:** The successful bidder will make the arrangements of the required equipment on the day of commencement or with respect to the progress of the work in phases, as per the instructions of site in charge. The successful bidder and, to that effect he will ensure commitment on an undertaking on Rs.500/- stamp paper to be submitted along with the Bid in Packet B. However, this condition in no way shall dilute the respective condition in Registration Rules of BMC.
- b) ~~**New and Original Works:** The bidder should, undertake their own studies and furnish with their bid, a detailed construction planning and methodology supported with assessment study of requirements of equipment/plants & machineries to allow the employer to review their proposal. The bidder will ensure his commitment to make the arrangements of the required equipment on the day of commencement or with respect to the progress of the work in phases, as per the instructions of site in charge on an undertaking on Rs.500 stamp paper to be submitted along with the Bid in Packet B. However, this condition in no way shall dilute the respective condition in Registration Rules of BMC.~~
- e) ~~**Special Works:** The concerned Ch.Eng. Shall enlist the equipments in the tender document justified for the project and ensure the capacity of the bidder for the same with the approval of concerned AMC.~~

Note: Bidders shall submit the undertaking for equipment capability and other undertakings as such on a single Rs.500/- stamp paper.

E) Technical Personnel

The contractor and/or its managerial staff should have qualification/experience appropriate to the function they fulfill. The minimum standard shall be increased by asking that at least one number or more of the contractor or its managerial staff have acquired qualifications or work experience to the needs of the contract. The minimum standard may also state that the person or persons responsible for managing the works must have a minimum of no's of years' experience working on similar nature of projects.

For fixing requirement of Technical Staff as required for this work.

(A) General Guidelines for Fixing Requirement of Technical Staff

Cost of Work (Rs. In Crore)	Requirement of Technical Staff (Major+Minor Component)		Minimum Experience (years)	Designation
	Qualification	Number		
More than 100	i) Graduate Engineer (Major Component)	1	20	Project Manager in Major Discipline of Engineering
	ii) Graduate Engineer	2+1	12	Deputy Project Manager in Major Discipline of Engineering
	iii) Graduate Engineer or Diploma Engineer	4	5	Project/Site Engineer
		2	10	
	iv) Graduate Engineer	1+1	8	Quality Engineer
	v) Diploma Engineer	1	8	Surveyor
vi) Graduate Engineer	1+1	6	Project Planning /Billing Engineer	
More than 50 to 100	i) Graduate Engineer	1	20	Project Manager
	ii) Graduate Engineer	1+1	12	Deputy Project Manager
	iii) Graduate Engineer or Diploma Engineer	2+1	5 or 10	Project/Site Engineer
	iv) Graduate Engineer	1	8	Quality Engineer
	v) Diploma Engineer	1	8	Surveyor
vi) Graduate Engineer	1+1	6	Project Planning /Billing Engineer	
More than 20	i) Graduate Engineer	1	20	Project Manager

to 50				
	ii) Graduate Engineer or Diploma Engineer	1+1	5 or 10	Project/Site Engineer
	iii) Graduate Engineer	1	8	Quality Engineer
	iv) Diploma Engineer	1	8	Surveyor
	v) Graduate Engineer	1+1	6	Project Planning /Billing Engineer

Notes:

- 1) "Cost of work", in table above, shall mean the agreement amount of the work.
- 2) Rate of recovery in case of non-compliance of the clause be stipulated at following rates:-

Sr. No.	Qualification	Experience (Years)	Rate of Recovery
1	Project Manager with Degree	20	Rs.60000/- p.m.
2	Deputy Project Manager with Degree	12	Rs.40000/- p.m.
3	Project/Site Engineer (Degree/Diploma)	5 or 10 respectively	Rs.25000/- p.m.
4	Quality Graduate Engineer	8	Rs.25000/- p.m.
5	Surveyor	8	Rs.15000/- p.m.
6	Project Planning /Billing Engineer	6	Rs.20000/- p.m.

- 3) Nothing extra need to be added while preparing market rate justified amount of the work if stipulation is made as per above recommended scale of technical staff.
- 4) Requirement of technical staff and their experience can be varied depending upon cost and complexity of the work by competent authority i.e. Chief Engineer with recorded reasons.
- 5) The failure in providing experienced technical and /professional ability personnel and even ignoring the instruction of the Engineer-in-charge shall be linked to penalization. Such disobeying attitude of the contractor shall also be reported to Vigilance/Registration & Monitoring department.

(B) General Guidelines for Fixing Requirement of Technical Staff

Cost of Work (Rs. In Crore)	Requirement of Technical Staff (Major+Minor Component)		Minimum Experience (years)	Designation
	Qualification	Number		

10 to 20	i) Project Manager with degree in corresponding discipline of Engineering	1	10	Principle Technical Representative
	ii) Graduate Engineer	1	5	Technical Representative
	iii) Graduate Engineer or Diploma Engineer	2 2	2 5	Project/Site Engineer and Project Planning /Billing Engineer.
More than 5 to 10	i) Graduate Engineer	1	5	Principle Technical Representative
	ii) Graduate Engineer or Diploma Engineer	2 2	2 5	Project/Site Engineer. Billing Engineer
More than 1.5 to 5	i) Graduate Engineer	1	5	Principle Technical Representative
	ii) Graduate Engineer or Diploma Engineer	1 1	2 5	Project/Site Engineer. Billing Engineer
Upto 1.5	ii) Graduate Engineer or Diploma Engineer	1 1	2 5	Principle Technical Representative Project/Site Engineer/ Billing Engineer

Notes:

- 1) "Cost of work", in table above, shall mean the agreement amount of the work.
- 2) Rate of recovery in case of non-compliance of the clause be stipulated at following rates:-

Sr.No	Qualification	Experience (Years)	Rate of Recovery
1	Project Manager with Degree	10	Rs.30000/- p.m.
2	Graduate Engineer	5	Rs.25000/- p.m.
3	Graduate Engineer	2	Rs.15000/- p.m.
4	Diploma Engineer	5	Rs.15000/- p.m.

- 3) Nothing extra need to be added while preparing market rate justified amount of the work if stipulation is made as per above recommended scale of technical staff.
- 4) Requirement of technical staff and their experience can be varied depending upon cost and complexity of the work by competent authority i.e. Chief Engineer with recorded reasons.

F. TIME PERIOD OF THE PROJECT:

Entire project should be completed and delivered within **6 months** of time from the date of award of contract excluding Monsoon.

The time allowed for carrying out the work as entered in the Tender shall be strictly observed by the Contractor and shall be reckoned from the date on which the Letter of Acceptance is given to the Contractor. The work shall throughout the stipulated period of the Contract be proceeded with all due diligence as time being deemed to be the essence of the contract on the part of the Contractor. On failing to do so, the Contractor shall pay as compensation an amount which shall be governed as per Clause - 8(e) of Standard General Conditions of Contract.

The Contractor should complete the work as per phase given below :

¼ of the work in	..	¼ of the time
½ of the work in	..	½ of the time
¾ of the work in	..	¾ of the time
Full of the work in	..	Full of the time

Full work will be completed in **06months(excluding monsoon)**.

The above programme is indicative and need to be worked out for every project for major activities) with respect to parameters such as labour, machineries, settling time, procurement and transportation of materials etc. The Dy.Chief Engineer shall approve the phase programme of the project in the Tender Document.

The programme for completion of work shall be a part of the Contract Document in the form of Bar Chart / GANTT Chart. The Contractor is supposed to carry out the work and keep the progress as per Bar Chart/GANTT Chart. The Contractor shall complete the work as per the Schedule given in the Contract and the programme submitted by the Contractor.

G. Contract Execution

All required documents for execution of the contract shall be submitted within 30 days from the date of issue of letter of acceptance. If the documents are not submitted within

the stipulated time a penalty of Rs 5000/- per day will be applicable to the contractor. All contract documents need to be duly affixed with stamp duty properly signed along with evidence/proof of payment of security/contract deposit/ within 30 days from the date of letter of acceptance received by him.

- H. If the amount of the Contract Deposit to be paid above is not paid within 30 days from the date of issue of Letter of Acceptance, the Tender / Contractor already accepted shall be considered as cancelled and legal steps be taken against the contractor for recovery of the amounts.
- I. The amount of Security Deposit retained by the BMC shall be released after expiry of period up to which the contractor has agreed to maintain the work in good order is over. In the event of the contractor failing or neglecting to complete the rectification work within the period up to which the contractor has agreed to maintain the work in good order, the amount of security deposit retained by BMC shall be adjusted towards the excess cost incurred by the Department on rectification work.

J. Action when whole of security deposit is forfeited:

In any case in which under any Clause of this contract, the contractor shall have rendered himself liable to pay compensation amounting to the whole of this security deposit whether paid in one sum or deducted by installments or in the case of abandonment of the work owing to serious illness or death of the contractor or any other cause, the Engineer on behalf of the Municipal Commissioner shall have power to adopt any of the following process, as he may deem best suited to the interest of BMC—

- a) To rescind the contract (for which recession notice in writing to the contractor under the head of Executive Engineer shall be conclusive evidence) and in that case, the security deposit of the contract shall stand forfeited and be absolutely at the disposal of BMC.
- b) To carry out the work or any part of the work departmentally debiting the contractor with the cost of the work, expenditure incurred on tools and plant, and charges on additional supervisory staff including the cost of work- charged establishment employed for getting the un-executed part of the work completed and crediting him with the value of the work done departmentally in all respects in the same manner and at the same rates as if it had been carried out by the contractor under the terms of his contract. The certificate of the Executive Engineer as to the costs and other allied expenses so incurred and as to the value of the work so done departmentally shall be final and conclusive against the contractor.

c) To order that the work of the contractor be measured up and to take such part thereof as shall be un-executed out of his hands, and to give it to another contractor to complete, in which case all expenses incurred on advertisement for fixing a new contracting agency, additional supervisory staff including the cost of work charged establishment and the cost of the work executed by the new contract agency will be debited to the contractor and the value of the work done or executed through the new contractor shall be credited to the contractor in all respects and in the same manner and at the same rates as if it had been carried out by the contractor under the terms of his contract. The certificate of the Executive Engineer as to all the cost of the work and other expenses incurred as aforesaid for or in getting the un-executed work done by the new contractor and as to the value of the work so done shall be final and conclusive against the contractor.

d) In case the contract shall be rescinded under Clause (a) above, the contractor shall not be entitled to recover or be paid any sum for any work therefore actually performed by him under this contract unless and until the Executive Engineer shall have certified in writing the performance of such work and the amount payable to him in respect thereof and he shall only be entitled to be paid the amount so certified. In the event of either of the courses referred to in Clause (b) or (c) being adopted and the cost of the work executed departmentally or through a new contractor and other allied expenses exceeding the value of such work credited to the contractors amount of excess shall be deducted from any money due to the contractor, by BMC under the contract or otherwise, howsoever, or from his security deposit or the sale proceeds thereof provided, however, the contractor shall have no claim against BMC even if the certified value of the work done departmentally or through a new contractor exceeds the certified cost of such work and allied expenses, provided always that whichever of the three courses mentioned in clauses (a), (b) or (c) is adopted by the Executive Engineer, the contractor shall have no claim to compensation for any loss sustained by him by reason of his having purchase or procured any materials or entered in to any engagements or made any advance on account of or with a view to the execution of the work or the performance of the contract.

K. Contract may be rescinded and security deposit forfeited for bribing a public officer or if contractor becomes insolvent

If the contractor assigns or sublets his contracts or attempt so to do, or become insolvent or commence any proceeding to get himself adjudicated and insolvent or make any composition with his creditors, or attempt so to do or if bribe, gratuity, gift, loan, perquisite, reward or advantage, pecuniary or otherwise, shall either directly or indirectly be given promised or offered by the contractor or any of his servants or agents through any public officer, or person in the employ of BMC/Govt. in any way

relating to his office or employment, or if any such officer or person shall become in any way directly or indirectly interested in the contract the Engineer In-charge may thereupon, by notice in writing rescind the contract and the Security Deposit of the Contractor shall thereupon stand forfeited and be absolutely at the disposal of BMC and the same consequences shall ensue as if the contract had been rescinded under above clause J hereof; and in addition the contractor shall not be entitled to recover or be paid for any work therefore actually performed under the contract.

➤ SUBMISSION OF TENDERS

PACKET-A

The Packet 'A' shall contain scanned certified copies of the following documents-

Scrutiny of this packet will be done strictly with reference to only the scanned copies of Documents uploaded online in packet 'A'

- a) Valid Registration Certificate.
- b) Valid Bank Solvency Certificate of Minimum Solvency amount as governed by Registration Rules in force for respective Class of Contractor for Civil and M&E works.
- c) A document in support of Registration GST successful tenderer shall submit Registration GST 15 days of issue of work order, failing which payment for the work executed will not be released.

Tax

"GST and other state levies/cess which are not subsumed under GST will be applicable. The tenderer shall quote inclusive of all taxes applicable at the time of bid submission. It is clearly understood that BMC will not bear any additional liability towards payment of any Taxes & Duties.

Wherever the services to be provided by the Tenderers, falls under Reverse Charge Mechanism, the Price quoted shall be exclusive of GST, but inclusive of Taxes/Duties/Cess other than GST, if any.

Rates accepted by BMC shall hold good till completion of work and no additional individual claim shall be admissible on account of fluctuations in market rates; increase in taxes/any other levies / tolls etc. except that payment/recovery for overall market situation shall be made as per Price variation **and if there is any subsequent change (after submission of bid) in rate of GST applicable on the work/services to be executed as per tender, i.e. any increase will be reimbursed by BMC whereas any reduction in the rate of GST shall be passed on to BMC as per the provisions of the GST Act.**

- d) Certified copies of valid 'PAN' documents and photographs of the individuals, owners, Karta of Hindu undivided Family, firms, private limited companies, registered co-operative societies, partners of partnership firms and at least two Directors, if number of Directors are more than two in case of Private Limited Companies, as the case may be. However, in case of Public Limited companies, Semi Government Undertakings, Government Undertakings, no 'PAN' documents will be insisted.
- e) Latest Partnership Deed in case of Partnership firm duly registered with Chief

Accountant (Treasury) of BMC.

f) The bidders shall categorically provide their Email-ID in packet 'A'.

g) Scanned copy of details of online payment of EMD shall be uploaded.

NOTE:

- If the tenderer(s) withdraw tender offer during the tender validity period, his entire E.M.D shall be forfeited.
- If it is found that the tenderer has not submitted required documents in Packet "A" then, the shortfalls will be communicated to the tenderer through e-mail only and compliance required to be made within a time period of **three working days** OR as mentioned in short tender notice otherwise they will be treated as non-responsive.

PACKET – B

The Packet 'B' shall contain scanned certified copies of the following documents –

- a) The list of similar type of works as stated in para 'A' of Post qualification successfully completed during the last seven years in prescribed proforma, in the role of prime contractor. Information furnished in the prescribed proforma (**Proforma– I**) shall be supported by the certificate duly self-attested. Documents stating that it has successfully completed during the last seven years at least one contract of similar works as stated in para 'A' of Post qualification.
- b) Annual financial turnover for **preceding three financial years as certified by Chartered Accountant** preceding the Financial Year in which bids are invited. **Copies of Applicants duly audited balance sheet and profit and loss account for the preceding three financial years preceding the Financial Year in which bids are invited. (Proforma – II)**
- c) Documents stating that, it has access to or has available liquid assets, unencumbered assets, lines of credit and other financial means (independent of any contractual advance payment) sufficient to meet the construction cash flow requirements for the subject contract in the event of stoppage, start-up, or other delay in payment, of the minimum 15% of the cost of the work tendered for, net of the tenderer's commitment of other contracts (Certificate from Bankers / C.A./Financial Institution shall be accepted as a evidence).
- d) The bidder shall give undertaking on Rs 500/-stamp paper that it is his/their sole responsibility to arrange the required machineries either owned/on lease or hire basis, at site before start of the work

- I. **Regular and Routine works:** The successful bidder shall make the arrangements of the required equipment on the day of commencement or with respect to the progress of the work in phases, as per the instructions of site in charge. The successful bidder and, to that effect he will ensure commitment on an undertaking on Rs.500 stamp paper to be submitted along with the Bid in Packet B. However, this condition in no way shall dilute the respective condition in Registration Rules of BMC.
- II. ~~**New and Original Works:** The bidder should, undertake their own studies and furnish with their bid, a detailed construction planning and methodology supported with assessment study of requirements of equipment/plants & machineries to allow the employer to review their proposal. The bidder shall ensure his commitment to make the arrangements of the required equipment on the day of commencement or with respect to the progress of the work in phases, as per the instructions of site in charge on an undertaking on Rs.500 stamp paper to be submitted along with the Bid in Packet B. However, this condition in no way shall dilute the respective condition in Registration Rules of BMC.~~
- III. Special Works : NA
- IV. Details of works in hand (Proforma VI-A & VI-B) (original), along with copies of work orders & attested copies of percentage of works completed or part thereof.
- V. Statement showing assessed available Bid Capacity.
- VI. The undertaking of Rs.500/- stamp paper as per the proforma annexed in 'Annexure B & C'.
- VII. **The Indemnity bond on Rs.500/- stamp paper stating tenderer shall indemnify BMC and all of its officers regarding any litigation or any issue that may arise out of ownership/NOC /permission of dumping sites as well as removal/transportation/disposal of excavated surplus earth including desilting material.**

Note: Bidders shall submit the undertaking for equipment capability and other undertakings as such on a single Rs.500/- stamp paper.

- VIII. The tenderers shall upload work plan as per the following outline:
- 1) GANTT chart/ PERT/ CPM chart showing the completion of work within prescribed time period, considering major activities.
 - 2) Organizational set up envisaged by the contractors.
 - 3) Plant & equipment proposed to be deployed for this work.
 - 4) Site Offices and Laboratories proposed to be setup.

- 5) A note on how the whole work will be carried out (work plan including methodology).
- 6) Quality management plan.
- 7) All the activities included in the Scope of Work shall be covered in the workplan.

IX. Corrigendum /Addendum, if any.

X. Information on Litigation History (Proforma VII) in which the tenderer is involved – Proforma as below

Other Party (ies)	Employer	Cause of Dispute	Amount involved.	Remarks showing Present Status.
1	2	3	4	5

Note:

- i. The Electrical / Mechanical work shall be got carried out by the civil contractors through the contractors registered with BMC. in Electrical Category. Information about the registered contractors shall be obtained from the office of the Ch.E. (M&E)/ E.E. (Monitoring & Registration Cell). Attested scanned copy of the valid registration certificate in Electrical Category shall be uploaded with the tender along with the undertaking from the registered Electrical Contractor stating his willingness to carry out the tenderwork.
- ii. The successful bidder shall submit valid registration certificate under E.S.I.C., Act 1948, if the tenderer has more than 10 employees /persons on his establishment (in case of production by use of energy) and 20 employees/persons on his establishment (in case of production without use of energy) to BMCas and when demanded. In case of less employees/persons mentioned above then the successful bidder has to submit an undertaking to that effect on Rs. 500 stamp paper as per circular u/no. CA/FRD/I/65 of 30.03.2013.
- iii. The successful bidder shall submit valid registration certificate under E.P.F. &M.P., Act 1952, if tenderer has more than 20 employees/persons on his establishment, to BMCas and when demanded. In case if the successful bidder has less employees/persons mentioned above then the successful bidder has to submit an undertaking to that effect on Rs. 500 stamp paper as per circular u/no. CA/FRD/I/44 of 04.01.2013.

Note:

- If it is found that the tenderer has not submitted required documents in Packet “B” then, the shortfalls will be communicated to the tenderer through e-mail only and compliance required to be made within a time period of **Three Working**

Days Or as mentioned in short tender notice otherwise they will be treated as non-responsive.

PACKET – C

- a) Online tender filled in either percentage plus or minus (above or below), or at par. (There is no separate provision to quote % in physical form, this is a part in Header Data of online Tendering). For Packet 'C' tenderer(s) will fill data in 'Item Data Tab' in Service Line Item via Details and quotes his percentage variation figures. **(If entered '0' it will be treated as 'at par'**. By default the value is zero only).

Note: In case of rebate/premium of 15% and above as quoted by the tenderer, the rate analysis of **major items of the bid shall be submitted**. The format for rate analysis is annexed at Annexure D.

Rate Analysis in prescribed format shall be submitted one day before opening of Packet 'C' before 5.00pm in seal Envelope to the respective Head Clerk (Expenditure) of S.W.D Division, failing which 10% EMD will be forfeited.

If rate analysis submitted by bidder is found unjustified, offer will be treated as non responsive and 10% EMD will be forfeited.

The format for rate analysis is annexed at **Annexure D**.

Tax

G.S.T. and other state levies/cess which are not subsumed under GST will be applicable. The tenderer shall quote inclusive of all taxes. It is clearly understood that BMC will not bear any additional liability towards payment of any Taxes & Duties.

Whenever the services to be provided by the Tenderers falls under **Reverse Charge Mechanism**, the Price quoted shall be exclusive of GST, but inclusive of Taxes/Duties/ Cess other than GST, if any.

Rates accepted by BMC shall hold good till completion of work and no additional individual claim shall be admissible on account of fluctuations in market rates; increase in taxes / any other levies/ tolls etc. except that payment/ recovery for overall market situation shall be made as per price Variation.

BID SECURITY OR EMD

- The Bidder shall furnish, as part of the Bid, Bid Security/EMD, in the amount specified in the Bid Data Sheet. This bid security shall be in favor of the authority mentioned in the Bid Data Sheet and shall be valid till the validity of the bid.

- The tenderers shall pay the EMD online instead paying the EMD at any of the CFC centre in BMCWardOffices.
- Any bid not accompanied by an acceptable Bid Security and not secured as indicated in sub-clause mentioned above, shall be rejected by the Employer as non-responsive.
- The Bid Security of the successful Bidder will be discharged when the Bidder has signed the Agreement and furnished the required SecurityDeposits.
- The Bid Security/ EMD and ASD of L-2 and other higher bidder (L-3, L-4, etc.) shall be refunded immediately after opening of financial bid as mentioned in circular issued by CA(F) u/n CA(F)/Project/32/ dtd. 26.10.2020.
- In case, the successful bidder becomes non-responsive or successful bidder withdraws the bid or is unwilling to extend the bid validity period, in such circumstances, if L-2 bidder is agreeable to extend the bid validity period and ready to deposit the requisite amount of bid security/EMD and ASD to the department within the stipulated time period i.e. 15 days, the department will process further as per normal procedure as mentioned in circular issued by CA(F) u/n CA(F)/Project/32/ dtd. 26.10.2020.

The Bid Security may be forfeited:

- a) if the Bidder withdraws the Bid after bid opening (opening of technical qualification part of the bid during the period of Bidvalidity;
 - b) in the case of a successful Bidder, if the Bidder fails within the specified time limitto:
 - i. sign the Agreement;and/or
 - ii.Furnish the required SecurityDeposits.
1. The cases wherein if the shortfalls are not complied by a contractor, will be informed to Registration and Monitoring Cell. Such non-submission of documents will be considered as 'Intentional Avoidance' and if three or more cases in 15 months are re- ported, shall be viewed seriously and disciplinary action against the defaulters such as banning/de-registration, etc. shall be taken by the registration cell with due approval of the concernedAMC.
 2. No rejections and forfeiture shall be done in case of curable defects. For non-curable defects the 10% of EMD shall be forfeited and bid will be liable forrejection.

Note:

- I. **Curable Defect shall mean shortfalls in submission suchas:**
 - a. **Non-submission of followingdocuments,**
 - i. **Valid RegistrationCertificate**

- ii. Valid Bank Solvency
- iii. GST Certificate(GST)
- iv. Certified Copies of PAN documents and photographs of individuals, owners, etc.
- v. Partnership Deed and any other documents
- vi. Undertakings as mentioned in the tender document.

II. Non-curable Defect shall mean

- a) In-adequate submission of EMD/ASD amount,
- b) In-adequacy of technical and financial capacity with respect to Eligibility criteria as stipulated in the tender.
- c) Wrong calculation of Bid Capacity,
- d) No proper submission of experience certificates and other documents, etc

BID VALIDITY

- Bids shall remain valid for a period of not less than one eighty (180) days after the deadline date for bid submission specified in Bid Data Sheet. A bid valid for a shorter period shall be rejected by the Employer as non-responsive.
- In exceptional circumstances, prior to expiry of the original time limit, the Employer may request that the bidders may extend the period of validity for a specified additional period. The request and the bidders' responses shall be made in writing or by cable. A bidder may refuse the request without forfeiting his Bid Security. A bidder agreeing to the request will not be required or permitted to modify his bid, but will be required to extend the validity of his bid security for a period of the extension.

DEFECT LIABILITY PERIOD

- The Contractor is expected to carry out the construction work in Workmen like manner so as to meet the requirement and specification for the project. It is expected that the Workmanship and materials will be reasonably fit for the purpose for which they are required.
- Defects or defective work is where standard and quality of workmanship and materials as specified in the contract is deficient. Defect is defined as a failure of the completed project to satisfy the express or implied quality or quantity obligations of the construction contract. Defective construction works are as the works which fail short of

complying with the express descriptions or requirements of the contract, especially any drawings or specifications with any implied terms and conditions as to its quality, workmanship, durability, aesthetic, performance or design. Defects in construction projects are attributable to various reasons.

- Some of the defects are structural defects results in cracks or collapse of faulty defective plumbing, inadequate or faulty drainage system, inadequate or faulty ventilation, cooling or heating systems, inadequate fire systems etc. The defects could be various on accounts of different reasons for variety of the projects.
- The Engineering In charge/Project Officer shall issue the practical completion certificate for the project. During the Defect Liability Period which commences on completion of the work, the Engineering In charge shall inform or the contractor is expected to be informed of any defective works by the Employer's representative of the defects and make good at contractor's cost with an intention of giving opportunity to the contractor of making good the defects appeared during that period. It is the contractor's obligation under the contract to rectify the defects that appear during Defect Liability Period and the contractor shall within a reasonable time after receipt of such instructions comply with the same at his own cost. The Engineering In charge/Project Officer shall issue a certificate to that effect and completion of making good defects shall be deemed for all the purpose of this contract to have taken place on the day named in such defect liability certificate.
- If defective work or workmanship or design have been knowingly covered-up or conceived so as to constitute fraud, commencement of the Defect Liability Period may be delayed. The decided period may be delayed until discover actually occurs on at least the defect could have been discovered with reasonable diligence, whichever is earlier.
- The DLP shall be asbelow:

Department	Type of Works	DLP
S.W.D.	SWD pipe drain/ Box drain/Culvert /Nalla Construction	5 years
	SWD Collapse walls	3 year
	SWD Civil Repairs in desilting works	1 year
	SWD Pumping Station	10 year

- Also, in case of defect, the Engineer shall give notice to the Contractor of any

Defects before the end of the Defects Liability Period, which begins at. The Defects Liability Period shall be extended for as long as Defects remain to be corrected. Every time notice of Defect/Defects is given, the Contractor shall correct the notified Defect/Defects within the duration of time specified by the Engineer's notice. The Engineer may issue notice to the Contractor to carry out removal of defects or deficiencies, if any, noticed in his inspection, or brought to his notice. The Contractor shall remove the defects and deficiencies within the period specified in the notice and submit to the Engineer a compliancereport.

- It is the Completion Stage when the contractor has completed all of the works and fixed all of the defects that were on the list of issue by Engineer-in-charge. When this happens, the engineer must issue a 'Certificate of Completion'. On the issue of 'Certificate of Completion', the 'Defect Liability Period' starts. The contractor also must issue a 'Certificate statement' as an acknowledgment to the engineer not later than 14 days after the 'Certificate of Completion' has been issued. During the 'Defect Liability Period', the contractor has to obey all written instructions from the engineer to carry out repairs and fix any defects which appear in the Permanent Works. If the contractor does not, due to his own faults finish the repair works or fix the defects by the end of 'Defect Liability Period', the 'Defect Liability Period' will continue until all works instructed by engineer is done.

SECURITY DEPOSIT AND PERFORMANCE GUARANTEE

A. Security Deposit

The security deposit shall mean and comprise of

- I. Contract Deposit and
- II. Retention Money.

I. Contract Deposit – The successful tender, here after referred to as the contractor shall pay an amount equal to **two (2) percent** of the contract sum in the form of Bank Guarantee and shall be paid within thirty days from the date of issue of letter of acceptance. **(Please refer New modified circular of CA (F))**

II. Retention Money – The contractor shall pay the retention money an amount equal to **Five (5) percent** of the Contract Sum which will be recovered from the contractors every bill i.e. interim / running / final bill and same shall be refunded after completion of DLP period or finalization of Final bill whichever is later.

B. Additional Security Deposit

The additional security deposit will be applicable when a rebate of more than 12 % at the rate of with no maximum limit. The ASD is calculated as follows: -

The ASD shall be paid offline and shall be applicable as under:-

Sr. No.	Rebate quoted by bidder	ASD applicable
1	Up to 12% rebate	No ASD
2	12.01% to 20% rebate	1% of Estimated Cost for each percentage & part thereof above 12% rebate
3	20.01% rebate and above	8% + 2% extra for each percentage and part thereof over and above 20% rebate

It is proposed to accept the A.S.D as applicable from respective bidders in the form of Demand Draft, which is to be submitted one day before opening of Packet 'C' before 5.00pm to the respective Head Clerk (Expenditure) of S.W.D Division in sealed envelope. If the bidders fails to submit the A.S.D applicable or submit inadequate A.S.D, in the form of D.D at least one day before opening of Packet C before 5.00pm then the E.M.D of the respective bidder will be forfeited."

Further if A.S.D is not applicable to the bidder, then the bidder has to submit a NIL report in seal Envelope to the respective Head Clerk (Expenditure) of S.W.D Division, one day before opening of Packet 'C' before 5.00pm.

C. Performance Guarantee:-

The successful tender, here after referred to as the contractor shall pay in the form of

“Performance Guarantee” at different rates for different slabs as stated below:

Offer	PG applicable %
For premium, at par and rebate 0 to 12%	PG= 0.92 % x Contract sum Applicable for rebate of 12%
For rebate of 12.01 % and above	PG= (0.92% x Contract Sum applicable for rebate of 12%) +(X) x Contract Sum where X= percentage rebate quoted more than 12%.

Note: Contract sum shall mean amount after application of rebate/premium as quoted by the contractor with contingencies only and excluding price variation.

The PG shall be paid in one of the following forms.

1. Cash (In case guarantee amount is less than Rs.10,000/-)
2. Demand Draft (In case guarantee amount is less than Rs.1,00,000/-)
3. Government securities
4. Fixed Deposit Receipts (FDR) of a Schedule Bank.
5. An electronically issued irrevocable bank guarantee bond of any Schedule bank or if in the prescribed form given in Annexure

Performance Guarantee is applicable over and above the clause of Security Deposit. Performance Guarantee will have to be paid & shall be valid till the defect liability period or payment of final bill whichever is later.

This deposit will be allowed in the form of 1 to 5 as mentioned above and shall be paid within 15 days after receipt of Letter of Acceptance.

D. Refund of Security Deposit

i. Refund of Contract Deposit

The Contract Deposit in the form **two (2) percent** of the contract sum in the form of Bank Guarantee, shall be released after completion of Defect Liability Period and after issue of ‘Defect Liability Certificate’, subject to no recoveries are pending against the said work, provided that the Engineer is satisfied that there is no demand outstanding against the Contractor.

ii. Refund of Retention Money

The Retention Money shall be released within 30 days after completion of DLP and after issue of ‘Defect Liability Certificate’ provided that the Engineer is satisfied that there is no demand outstanding against the Contractor. In the event of different Defects Liability Periods

have been specified or become applicable to different sections or parts of the Permanent Works, the said moneys will be released within 30 days on expiration of the latest of such Defects Liability Periods.

Payment of the above mentioned is exclusive of the amounts to be withheld as stated in and that amount shall be paid as per condition stated therein.

iii. **Refund of Additional Security Deposit**

The additional security deposit shall be released within 30 days of issue of 'Certificate of Completion' with respect to the whole of the Works. In the event the Engineer issues a Taking-over Certificate for a section or part of the Permanent Works, only such proposition thereof as the Engineer determines (having regard to the relative value of such section or part of the Works) shall be considered by the Engineer for payment to the Contractor.

iv. **Refund of Performance Guarantee**

The Deposit on account of performance guarantee shall be released within 30 days of completion of Defects Liability Certificate subject finalization of final bill whichever is later and no recoveries are pending against the said work, provided that the Engineer is satisfied that there is no demand outstanding against the Contractor.

❖ Summary of time of Refund of deposit is tabulated as follows:

A. Time of Refund for works having 1 or 3 or 5 years DLP

Deposits refunded after completion	After completion of DLP
ASD	CD + 100% of RM + PG

B. Time of Refund for works having 10 years DLP

Deposits refunded after completion	After 5 years of DLP	After completion of DLP
ASD	CD	PG + 100 % of RM

*Note:

33 It shall be clearly mentioned that the BG shall be applicable for individual work/contract and clubbing of various contracts of the said contractor will not be allowed. In case of obtaining Bank Guarantee, it is necessary to mention that the same shall be valid further 6 months from the completion of defect liability period/ warranty period.

34 It shall be the responsibility of the bidder to keep the submitted B.G. "VALID" for the stipulated time period in the tender & in case of its expiry it will attract penalization.

35 Bank Guarantee should be issued by way of General Undertaking and Guarantee issued on behalf of the Contractor by any of the Nationalized or Scheduled banks or branches of foreign banks operating under Reserve Bank of India regulations located in Mumbai upto Virar & Kalyan. List of approved Banks is appended at the end of Instructions to Bidders (ITB). The Bank Guarantee issued by branches of approved Banks beyond Kalyan and Virar can be accepted only if the said Bank Guarantee is countersigned by the Manager of a Regional Branch of the same bank within the Mumbai City Limit categorically endorsing thereon that the said Bank Guarantee is binding on the endorsing Branch of the Bank or the Bank itself within Mumbai Limits and is liable to be enforced against the said Branch of the Bank or the bank itself in case of default by the Contractors furnishing the Bank Guarantee. The Bank Guarantee shall be renewed as and when required and/or directed from time to time until the Contractor has executed and completed the works and remedied any defects therein.

E. Legal + Stationary Charges: (As per applicable circular)

Successful tenderer shall pay the Legal Charges + Stationary charges as per Circular no. Legal/ 10318 / dated 24.03.2022 :-

Contract Value						Legal+ Stationery Charges
from	Rs.	10,001/-	To	Rs.	50,000/-	Nil
from	Rs.	50,001/-	To	Rs.	1,00,000/-	Rs.6290/-
from	Rs.	1,00,001/-	To	Rs.	3,00,000/-	Rs.10380/-
from	Rs.	3,00,001/-	To	Rs.	5,00,000/-	Rs. 12470/-
from	Rs.	5,00,001/-	To	Rs.	10,00,000/-	Rs. 14510/-
from	Rs.	10,00,001/-	To	Rs.	20,00,000/-	Rs. 16570/-
from	Rs.	20,00,001/-	To	Rs.	40,00,000/-	Rs. 18660/-
from	Rs.	40,00,001/-	To	Rs.	1,00,00,000/-	Rs. 20720/-
from	Rs.	1,00,00,001/-	To	Rs.	10,00,00,000/-	Rs. 24450/-
from	Rs.	10,00,00,001/-	To	Rs.	20,00,00,000/-	Rs. 28220/-
from	Rs.	20,00,00,001/-	To	Rs.	30,00,00,000/-	Rs. 31980/-
from	Rs.	30,00,00,001/-	To	Rs.	40,00,00,000/-	Rs. 35740/-
from	Rs.	40,00,00,001/-	To	Rs.	50,00,00,000/-	Rs. 39470/-
from	Rs.	50,00,00,001/-	To	Rs.	1,00,00,00,000/-	Rs. 47000/-
from	Rs.	1,00,00,00,001/-	To	Rs.	2,00,00,00,000/-	Rs. 58270/-
from	Rs.	2,00,00,00,001/-	To	Rs.	3,00,00,00,000/-	Rs. 65770/-
from	Rs.	3,00,00,00,001/-	To	Rs.	4,00,00,00,000/-	Rs. 75120/-
from	Rs.	4,00,00,00,001/-	To	Rs.	5,00,00,00,000/-	Rs. 84510/-
from	Rs.	5,00,00,00,001/-	To	Rs.	Any higher amount	Rs. 93920 /-(Maximum)

The tenderers are requested to note that stationary charges as given in the table above will be recovered from the successful tenderer for supply of requisite prescribed forms for preparing certificate bills in respect of the work.

F. Stamp Duty: (As per applicable circular)

It shall be incumbent on the successful tenderer to pay stamp duty on the contract.

- I. As per the provision made in Article 63, Schedule I of Bombay Stamp Act 1958, stamp duty is payable for “works contract” that is to say, a contract for works and labour or services involving transfer of property in goods (whether as goods or in some other form) in its execution and includes a sub-contract, as under :

(i)	Where the amount or value set forth in such contract does not exceed rupees Ten lakhs	500 rupees stamp Duty
(ii)	Where it exceeds rupees Ten lakhs	500 rupees plus one hundred rupees for every 1,00,000/- or part thereof, above rupees ten lakh subject to the maximum of rupees 25 lakh stamp duty

- II. The successful bidder shall enter into a contract agreement with B.M.C. within 30 days from the date of issue of Work Order and the same should be adjudicated for payment of Stamp Duty by the successful bidder.
- III. Further shortfall if any, in amount of stamp duty paid as against prescribed amount for the documents executed in Mumbai City & Mumbai Suburban District be recovered from the concerned work contractors and to deposit the deficit or unpaid Stamp Duty and penalty by two separate Demand Draft or Pay Order in favor of “Superintendent of Stamp, Mumbai” within 15 days from intimation thereof.
- IV. All legal charges and incidental expenses in this respect shall be borne and paid by the successful tenderer.

IMPORTANT DIRECTIONS

1. All the information uploaded shall be supported by the corroborative documents in absence of which the information uploaded will be considered as baseless and not

accepted for qualification criteria. All the documents shall be uploaded with proper pagination. The page No. shall be properly mentioned in the relevant places.

The information shall be uploaded in the sequence as asked for with proper indexing etc. The Bidder shall be fully responsible for the correctness of the information uploaded by him.

2. Applicants/Bidders shall refer [portal.mcgm.gov.in\](http://portal.mcgm.gov.in/tenders)tenders for "The Manual of Bid-Submission for Percentage Rate/Item Rate Tender Document." The detail guidelines for creation and submission of bid are available in the referred document.

Any queries or request for additional information concerning this TENDER shall be submitted by e-mail to dyche01es.swd@BMC.gov.in The subject shall clearly bear the following identification/ title: **"Queries/ Request for Additional Information:**

In **TENDER for ES - 435 Training and Widening of Laxmibaug nalla at Sidhrameshwar Nagar, Ghatkopar(E) in N Ward.(Brimstowad work).**In case of **Equal Percentage** of lowest bidders (L1), the allotment of work shall be done by giving 48 hrs(**2 working days**) from the day of opening of packet C **on same BID-Document number for re-quoting** and such development needs to be done by IT department in BMC's SRM system. **Till such development is made; 'Sealed Bids' shall be called from the bidders quoting the same rates i.e.L1.**

In case of equal percentage of lowest bidders is obtained even after re-quoting, then the successful bidder will be decided by lottery system by concerned **Ch.Eng.**

The Bidder shall submit the A.S.D as applicable in the form of Demand Draft, which is to be submitted one day before opening of Packet 'C' i.e. before 5.00pm to the respective Head Clerk (Expenditure) of S.W.D Division in sealed envelope. If the bidder fails to submit the A.S.D applicable or submit inadequate A.S.D, in the form of D.D at least one day before opening of Packet C i.e. before 5.00pm then the E.M.D of the respective bidder will be forfeited."

Further if A.S.D is not applicable to the bidder, then the bidder has to submit a NIL report in seal Envelope to the respective Head Clerk (Expenditure) of S.W.D Division, one day before opening of Packet 'C' i.e. before 5.00pm

SECTION 7
SCOPE OF WORK

SCOPE OF WORK

Name of the Work: -ES - _____ Training and Widening of Laxmibaug nalla at Sidhrameshwar Nagar, Ghatkopar(E) in N Ward.

1) **Scope of the work:** -The Tenderer / Contractor shall note that this contract envisages following works in general:-

2) **The Major Components of this work are:-**

- Construction of R.C.C. Box drain.
- Construction of road side drain in R.C.C. walls with R.C.C. slab/ covering.
- All SWD / Nalla walls to be constructed in RCC.
- Box Drains, Culvert raft / walls / slab / Pile work to be constructed in R.C.C. / having a grade of concrete M-15 / M-20 / M-25 / M-40.
- Reinstatement of approach road abutting to box drain/Culvert
- Thermo-Mechanically Treated steel bars / CRS bars. (Fe 500 D) to be used in R.C.C.
- Construction of Footpath.
- Use of R.M.C. for all concrete works.
- Use of R.M.C. for all concrete works. if otherwise some regions which are out of scope of RMC vehicles due to lack of roads and narrow bye lanes.
- Repair/ Construction of Collapsed walls/Improvement of minor/major nalla in the vicinity within scope, if required as per instructions of Engineer- In -Charge.
- Contractor have to make arrangement for own dumping plot.
- Any unforeseen work if arises related to catchment area (ongoing work)
- The trees affected in the alignment of SWD and Pathway shall be removed by obtaining permission from tree authority. The successful tenderer(s) has to deposit the requisite amount with Tree authority for faithful compliance of permission from Tree Authority.

- Desilting of existing SWD/nalla throughout the contract period at risk and cost of tenderer(s). No payment to the contractor will be made on this account.
- To carry out total station survey and submit to the office of Dy.Ch. Engg. (SWD)ES before starting of the work.
- To submit the structural design of all works before starting of works and get it approved from competent authority.
- The contractor is to make all necessary arrangements for utility shifting, diversion of flow for enlarging the construction, dewatering, utility diversion. The contractor shall quote the tender keeping these points in mind. The contractor should take into account and make necessary arrangement for the safety of adjoining structure.
- As per circular of Dy.Ch.Eng. (SWM) OP vide circular u/no. Dy.Ch.Eng. /SWM/3957/OP dtd. 28.09.2018 contractor has to submit the quantity of excavated material generated along with proper records in standard format to A.E. (SWM) of concerned ward and obtain NOC/Permission for the disposal of material.

Estimated cost of the work : - As per the Tender notice.

Note :-

- (i). All the works contained in the scope of work shall be carried out strictly as per relevant specifications applicable as attached or referred to, in this tender document.
- (ii).The above is general description of the scope of work and actual work mentioned above shall be governed by B.O.Q. and as directed by the Engineer-in-Charge.
- (iii). Applicable schedules.:- Unified schedule of rates for S.W.D., Building construction, Road works, Bridge works, Hydraulic Engineering, Sewerage Projects etc. effective from 20.06.2018.

SECTION 8
BILL OF QUANTITIES

ES - ____ Training and Widening of Laxmibaug nalla at Sidhrameshwar Nagar, Ghatkopar(E) in N Ward.(

Abstract Sheet

Sr.No	Item No.	Description	Qty.	Per	Rate	Amount
1	R2-CS-PLG-1-1-b	Providing and Casting RCC bored cast in-situ Vertical as per IS 2911 (Part 1, Section 2) by boring through all kinds of soils/ Sand /Rock by rotary hydraulic rigs using temporary casing up to stable strata / bentonite mud circulation as specified, from tip to cut-off elevation of piles. Note : Cost of temporary casing shall be incurred by the Contractor.	2790.00	Rmt	5125.00	14298750.00
2	R2-CS-PLG-2-4	Extra over rate for items CS-PLG-1 & 2 for using M40 instead of M 25	2790.00	Rmt	226.00	630540.00
3	R2-SWD-179	P & P in position controlled RMC of grade M- 40 in walls and deck slab	330.00	Cum	9569.00	3157770.00

4	R2-CS-RF-7-b	<p>Leak-proof Shuttering for Encasement: Providing, fabricating & fixing the leak-proof shuttering made with marine plywood/M.S. sheets with proper supports at all locations for all shapes etc., for encasement & deshuttering the same after specified period or next day of placing the microconcrete / concrete. Providing & applying approved oil on all surfaces of formwork coming in contact with concrete as per specification for Walls (any thickness) including attached butresses, retaining wall, shear wall, diaphragm wall etc</p>	930.0 0	sqm	558.0 0	518940.00
5	R2-CS-CW-35-c	Thermo-Mechanically Treated steel bars. (Fe 500 D)	188.0 00	MT	7677 0.00	14432760.00
6	R2-CS-PLG-5.1	Providing and installing in position permanent M.S. liners for piles of specified diameter and fabricated from 6.0mm	278.0 00	MT	7977 7.00	22178006.00

		to 8.0mm thick plates as per detailed drawings and designs including cutting, bending to required shape, welding, painting with Red Oxide paint etc. complete as specified and directed.				
7	R2-BW-5-3-c	P/A epoxy base paint to RCC piers, columns, beams, girders, diaphragms, slabs, parapets etc. including cleaning the surfaces thoroughly so as to remove deposited salts, oil, grease, tar, moisture etc. from the surface, preparing the surface, applying putty consisting of epoxy base paint and steolite powder, to render the concrete surfaces smooth by covering small irregularities and applying one coat of epoxy paint including scaffolding. (2 coats epoxy + primer)	1085.00	Sq. M.	412.00	447020.00

8	R2-CS-PLG-3.0	Empty boring through over burden including road crust upto the bottom of pile cap for alldiameters of piles.	140.00	RM T	1990.00	278600.00
9	R2-BW-2-36-a	Providing and installing in position temporary M.S. liners for piles (empty boring) of specified diameter and fabricated from 6.0 to 8.0mm thick plates as per detailed drawings and designs including cutting, bending to required shape, welding, painting with Red Oxide paint	17.000	MT	55997.00	951949.00
10	R2-SWD-15-A	Providing and laying RMC M-15 grade Plain cement concrete in foundation	27.000	Cu m	6764.00	182628.00
11	R2-CS-EW-26	Providing & Laying dry stone Rubble Soling with average 230 mm size hard stone set in regular lines, handpacked and interstices thoroughly filled with small chips including filling in with good quality murum brought from outside, compacting with iron rammers, watering,	25.00	Cu m	2231.00	55775.00

		sandspreading 12mm thk. layer of grit on top etc complete as directed by Engineer In Charge. (Note: The rate includes the royalty and other taxes if any)				
12	R2-CS-EW-1	Excavation for foundations, substructures, basements, tanks, sumps, walls, chambers, manholes, trenches, poles, pits & general building works in all types of soils, vegetable earth, soft murum, running sand, shingle, turf clay, loam, peat, ash, shale, slag, chalk, garbage, muddy/ marshy/ slushy soil, marine clay, reclaimed land etc. for depths/lifts upto 1.5M measured	135.0 0	Cu m	307.0 0	41445.00
13	R2-SWD-34	Cutting down stone, concrete, brick masonry work by any means in lime or cement mortar including plaster pointing in compound walls, arches, piers / wing wall abutments etc.complete	36.00	CU M	484.0 0	17424.00

		as specified & directed				
14	R2-CS-PLG-14.3	Carrying out low strain pile integrity test on 300mm / 350mm / 400mm / 450mm / 500mm / 600mm / 750mm / 900mm diameter pile	186.00	Nos	2950.00	548700.00
15	R2-CS-PLG-17.5	Carrying out Initial Lateral Load Test on vertical (Initial/test) piles up to maximum test load of 2.0 times the safe lateral load capacity on single pile as specified in accordance with IS 2911 part-4 including all necessary arrangements such as jacks, measuring devices,	7.00	Nos	413000.00	2891000.00
16	R2-CS-PLG-21.5	Conducting routine vertical load test for 1.5 times safe load carrying capacity by means of High Strain Dynamic Load Test	7.00	Nos	188800	1321600

17	R2-SWD-154	P/F 100 mm. dia PVC. Pipes of approved quality as weep holes in nalla/retaining walls	89.00	RM T	355	31595
18	R2-RW-7-21	Cutting down of tree having diameter above 150 mm & Upto 300 mm'	6.00	Each	3146	18876
19	R2-RW-7-19	Transplantation of existing trees of girth of all dia. including uprooting and shifting of the tree and placing in pits of suitable size and after transplanting, removal of excavated earth to desired location, filling the pit with reearth, manure, watering etc. complete with all leads, lifts, including maintenance for 3 years. The item also includes backfilling of the trench taken for exposing the root system of the tree proposed to be transplanted etc. complete as directed by Engineer-in-charge	7.00	Per No	5546	38822

20	R2-CS-SS-16	<p>Providing, detailing, and fabricating as per specifications, transporting to site and erecting MS Openable / Sliding / Ornamental Entrance Gates including track and wheel, locking arrangement, fixing bolts, nuts, washers, cleats, stiffeners, gussets decorative balusters, arrow heads etc. and all necessary operations like straightening, bending, cutting, drilling, grinding, machining if specified, welding etc. complete weighing 60 to 65 kg/Sqm, including cleaning, Grinding and removing the welding burr and preparing surface and applying one coat of red oxide zinc chromate primer and one coat of Synthetic Enamel paint after fabrication and second coat of Synthetic Enamel paint after erection, with approved colour, shade and brand etc. including touching up</p>	9.00	Sq Mtr	7834	70506
----	-------------	---	------	-----------	------	-------

		with primer etc. complete as directed by Engineer In Charge.				
21	R2-RW-8- 01	Providing & fixing 150mm dia RCC NP2class,jointing, filletting in 1:1C.M.,etc as per item	2.00	Rmt	454	908
					Total	6,21,13,614.00

SECTION 9
GENERAL CONDITIONS OF
CONTRACT

General Conditions of Contract

A. General

1. Definitions

1.1 Terms which are defined in the Contract Data are not also defined in the Conditions of Contract but keep their defined meanings. Capital initials are used to identify defined terms.

The “Contract” shall mean the tender and acceptance thereof and the formal agreement if any, executed between the Contractor, Commissioner and the Corporation together with the documents referred to therein including these conditions and appendices and any special conditions, the specifications, designs, **drawings**, price schedules, bills of quantities and schedule of rates. All these documents taken together shall be deemed to form one Contract and shall be complementary to one another.

The Contract Data defines the documents and other information which comprise the Contract.

The “Contractor” shall mean the individual or firm or company whether incorporated or not, whose tender has been accepted by the employer and the legal successor of the individual or firm or company, but not (except with the consent of the Employer) any assignee of such person.

The Bidder is a person or corporate body who has desired to submit Bid to carry out the Works, including routine maintenance till the tender process is concluded.

The Contractor's Bid is the completed bidding document submitted by the Contractor to the Employer.

The “Contract Sum” means the sum named in the letter of acceptance including Physical contingencies subject to such addition thereto or deduction there-from as may be made under the provisions hereinafter contained.

Note : The contract sum shall include the following –

- In the case of percentage rate contracts the estimated value of works as mentioned in the tender adjusted by the Contractor's percentage.
- In the case of item rate contracts, the cost of the work arrived at after finalization of the quantities shown in schedule of items / **quantities** by the item rates quoted by the tenderers for various items and summation of the extended cost of each item.
- In case of lump sum contract, the sum for which tender is accepted.
- Special discount / rebate / trade discount offered by the tenderer if any and accepted by the Corporation.
- Additions or deletions that are accepted after opening of the tenders.

The “Contract Cost” means the Contract Sum plus Price Variation. This cost shall be

included in the letter of acceptance.

A Defect is any part of the Works not completed in accordance with the Contract.

The Defects Liability Certificate is the **certificate** issued by the Engineer, after the Defect Liability Period has ended and upon correction of Defects by the Contractor.

Drawings means all the drawings, calculations and technical information of a like nature provided by the Engineer to the Contractor under the Contract and all drawings, calculations, samples, patterns, models, operation & maintenance manual and other technical information of like nature submitted by the Contractor and approved by the Engineer.

The Authority shall mean Brihanmumbai Municipal Corporation (BMC)

The “Employer” shall mean the **Brihanmumbai Municipal Corporation (BMC) / Municipal Commissioner for Greater Mumbai**, for the time being holding the said office and also his successors and shall also include all “Additional Municipal Commissioners, Director (Engineering Services & Projects)” and the Deputy Municipal Commissioner, to whom the powers of Municipal Commissioner, have been deputed under Section 56 and 56B of the Mumbai Municipal Corporation Act.

The Engineer in-charge shall mean the Executive Engineer in executive charge of the works and shall include the superior officers of the Engineering department i.e. Dy.Ch.Eng/Ch.Eng. and shall mean and include all the successors in BMC

The Engineer's Representative shall mean the Assistant Engineer, Sub. Engineer/Jr. Engineer in direct charge of the works and shall include Sub Eng./ Jr. Eng of Civil section/ Mechanical section/ Electrical section appointed by BMC.

The “Engineer” shall mean the City Engineer / the Hydraulic Engineer / the Chief Engineer / the Special Engineer, appointed for the time being or any other officer or officers of the Municipal Corporation who may be authorized by the commissioner to carry out the functions of the City Engineer / the Hydraulic Engineer / the Chief Engineer / the Special Engineer or any other competent person appointed by the employer and notified in writing to the Contractor to act in replacement of the Engineer from time to time.

Contractor's Equipment means all appliances and things of whatsoever nature required for the execution and completions of the Works and the remedying of any defects therein, but does not include plant material or other things intended to form or forming part of the Permanent Works.

The Initial Contract Price is the Contract Price listed in the Employer's Letter of Acceptance.

The Intended Completion Date is the date on which it is intended that the Contractor shall complete the construction works. The Intended Completion Date is specified in the Contract Data. The Intended Completion Date may be revised only by the Engineer by issuing an extension of time.

Materials are all supplies, including consumables, used by the Contractor for incorporation in the Works and works of routine maintenance.

Plant is any integral part of the Works that shall have a mechanical, electrical, electronic, chemical, or biological function.

Routine Maintenance is the maintenance of activities of the completed structure for five years as specified in the Contract Data.

The “Site” shall mean the land and other places including water bodies more specifically mentioned in the special conditions of the tender, on, under in or through which the permanent works or temporary works are to be executed and any other lands and places provided by the Municipal Corporation for working space or any other purpose as may be specifically designated in the contract as forming part of the site.

Site Investigation Reports are those that were included in the bidding documents and are reports about the surface and subsurface conditions at the Site.

“Specification” shall mean the specification referred to in the tender and any modification thereof or addition or deduction thereto as may from time to time be furnished or approved in writing by the Engineer.

The Start Date/Commencement Date is given in the Contract Data. It is the date when the Contractor shall commence execution of the Works. It does not necessarily coincide with any of the Site Possession Dates.

A Nominated Sub-Contractor is a person or corporate body who has a Contract with the Contractor to carry out a part of the construction work and/or routine maintenance in the Contract, which includes work on the Site.

Temporary Works are works designed, constructed, installed, and removed by the Contractor that are needed for construction or installation of the Works.

Variation means a change to the:-

- i) Specification and /or Drawings (if any) which is instructed by the Employer.
- ii) Scope in the Contract which is instructed by the Employer.
- iii) Price in the Contract which is instructed by the Employer.

The Works, as defined in the Contract Data, are what the Contract requires the Contractor to construct, install, maintain, and turn over to the Employer. Routine maintenance is defined separately.

Jurisdiction: In case of any claim, dispute or difference arising in respect of a contract, the cause of action thereof shall be deemed to have arisen in Mumbai and all legal proceedings in respect of any claim, dispute or difference shall be instituted in a competent court in the City of Mumbai only.

2. Interpretation

- 2.1 In interpreting these Conditions of Contract, singular also means plural, male also means female or neuter, and the other way around. Headings have no significance. Words have their normal meaning under the language of the Contract unless specifically defined. The Engineer will provide instructions clarifying queries about these Conditions of Contract.
- 2.2 If sectional completion is specified in the Contract Data, references in the Conditions of Contract to the Works, the Completion Date, and the Intended Completion Date apply to any Section of the Works (other than references to the Completion Date and Intended Completion Date for the whole of the Works).
- 2.3 The documents forming the Contract shall be interpreted in the following documents: (1) Agreement, (2) Letter of Acceptance, (3) Notice to Proceed with the Work, (4) Contractor's Bid, (5) Contract Data, (6) Special Conditions of Contract Part (7) General Conditions of Contract Part I, (8) Specifications, (9) Drawings, (10) Bill of Quantities, and (11) Any other document listed in the Contract Data.

3. Engineer's Decisions

3.1 Except where otherwise specifically stated, the Engineer will decide contractual matters between the Employer and the Contractor in the role representing the Employer. However, if the Engineer is required under the rules and regulations and orders of the Employer to obtain prior approval of some other authorities for specific actions, he will so obtain the approval, before communicating his decision to the Contractor.

3.2 Except as expressly stated in the Contract, the Engineer shall not have any authority to relieve the Contractor of any of his obligations under the contract.

4. Delegation

4.1 The Engineer, with the approval of the Employer, may delegate any of his duties and responsibilities to other person(s), except to the Adjudicator, after notifying the Contractor, and may cancel any delegation after notifying the Contractor.

5. Communications

All certificates, notices or instructions to be given to the Contractor by Employer/ Engineer shall be sent on the address or contact details given by the Contractor of Bid. The address and contact details for communication with the Employer/ Engineer shall be as per the details given in Contract Data. Communications between parties that are referred to in the conditions shall be in writing. The Notice sent by facsimile (fax) or other electronic means shall be effective on confirmation of the transmission. The Notice sent by Registered post or Speed post shall be effective on delivery or at the expiry of the normal delivery period as undertaken by the postal service.

6. Subcontracting

6.1 Unless specifically mentioned in the contract subletting will not be allowed.

Subletting, where otherwise provided by the contract shall not be more than 25% of the contract price.

6.2 The Contractor shall not be required to obtain any consent from the Employer for:

- a. the sub-contracting of any part of the Works for which the Subcontractor is named in the Contract;
- b. the provision for labour, or labour component.
- c. the purchase of Materials which are in accordance with the standards specified in the Contract.

6.3 Beyond what has been stated in clauses 6.1 and 6.2, if the Contractor proposes sub contracting any part of the work during execution of the Works, because of some unforeseen circumstances to enable him to complete the Works as per terms of the Contract, the Employer will consider the following before according approval:

- a) The Contractor shall not sub-contract the whole of the Works.
- b) The permitted subletting of work by the Contractor shall not establish any contractual relationship between the sub-contractor and the BMC and shall not relieve the Contractor of any responsibility under the Contract.

6.4 The Engineer should satisfy himself before recommending to the Employer whether

- a) the circumstances warrant such sub-contracting; and
- b) the sub-Contractor so proposed for the Work possesses the experience, qualifications and equipment necessary for the job proposed to be entrusted to him.

7. Other Contractors

7.1 The Contractor shall cooperate and share the Site with other Contractors, public authorities, utilities, and the Employer between the dates given in the Schedule of Other Contractors, as referred to in the Contract Data. The Contractor shall also provide facilities and services for them as described in the Schedule. The Employer may modify the Schedule of Other Contractors, and shall notify the Contractor of any such modification.

7.2 The Contractor should take up the works in convenient reaches as decided by the Engineer to ensure there is least hindrance to the smooth flow and safety of traffic including movement of vehicles and equipment of other Contractors till the completion of the Works.

8. Personnel

8.1 The Contractor shall employ for the construction work and routine maintenance

the key personnel including technical personnel named in the Contract Data or other personnel approved by the Engineer. The Engineer will approve any proposed replacement of technical personnel only if their relevant qualifications and abilities are substantially equal to those of the personnel stated in the Contract Data.

8.2 The Contractor's personnel shall appropriately be qualified, skilled and experienced in their respective trades or occupations. The Engineer shall have authority to remove, or cause to be removed, any person employed on the site or works, who carries out duties incompetently or negligently and persists in any conduct which is prejudicial to safety, health or the protection of the environment.

8.3 If the Engineer asks the Contractor to remove a person who is a member of the Contractor's staff or work force, stating the reasons, the Contractor shall ensure that the person leaves the Site within seven days and has no further connection with the Works in the Contract.

8.4 The Contractor shall not employ any retired Gazetted officer who has worked in the Engineering Department of the BMC/State Government and has either not completed two years after the date of retirement or has not obtained BMC/State Government's permission to employment with the Contractor.

9. Employer's and Contractor's Risks

9.1 The Employer carries the risks which this Contract states are Employer's risks, and the Contractor carries the risks which this Contract states are Contractor's risks.

10. Employer's Risks

10.1 The Employer is responsible for the excepted risks which are (a) in so far as they directly affect the execution of the Works in the Employer's country, the risks of war, invasion, act of foreign enemies, rebellion, revolution, insurrection or military or usurped power, civil war, riot, commotion or disorder (unless restricted to the Contractor's employees) and contamination from any nuclear fuel or nuclear waste or radioactive toxic explosive, or (b) a cause due solely to the design of the Works, other than the Contractor's design.

11. Contractor's Risks

11.1 All risks of loss of or damage to physical property and of personal injury and death which arise during and in consequence of the performance of the Contract other than the excepted risks, referred to in clause 11.1, are the responsibility of the Contractor.

12. Insurance

12.1 The Contractor at his cost shall provide, in the joint names of the Employer and the Contractor, insurance cover from the Start Date to the end of Defects

Liability Period, in the amounts and deductibles stated in the Contract Data for the following events which are due to the Contractor's risks:

- a) Loss of or damage to the Works, Plant and Materials;
- b) Loss of or damage to Equipment;
- c) Loss of or damage to property (other than the Works, Plant, Materials, and Equipment) in connection with the Contract; and
- d) Personal injury or death.

12.2 Insurance policies and certificates for insurance shall be delivered by the Contractor to the Engineer for the Engineer's approval before the Start Date. All such insurance shall provide for compensation to be payable in the types and proportions of currencies required to rectify the loss or damage incurred.

12.3 Alterations to the terms of insurance shall not be made without the approval of the Engineer.

12.4 Both parties shall comply with any conditions of the insurance policies.

12.5 If the Contractor does not provide any of the policies and certificates required, the Employer may affect the insurance which the Contractor should have provided and recover the premiums the Employer has paid, from payments otherwise due to the Contractor or if no payment is due, the payment of premiums shall be debt due.

13. Site Investigation Reports

13.1 The Contractor, in preparing the Bid, may rely, at his own risk, on any Site Investigation Reports referred to in the Contract Data, supplemented by any other information available to him, before submitting the bid.

14. Queries about the Contract Data

14.1 The Engineer will clarify queries on the Contract Data.

15. Contractor to Construct the Works and Undertake Maintenance (if specified in the tender)

15.1 The Contractor shall construct, and install and maintain the Works in accordance with the Specifications and Drawings and as per instructions of the Engineer.

15.2 The Contractor shall construct the works with intermediate technology, i.e., by manual means with medium input of machinery required to ensure the quality of works as per specifications. The Contractor shall deploy the equipment and machinery as required in the contract.

15.3 The Contractor shall take all reasonable steps to protect the environment on and off the Site and to avoid damage or nuisance to persons or to property of the public or others resulting from pollution, noise or other causes arising as a consequence of his methods of operation.

During continuance of the contract, the Contractor and his sub-contractors shall abide at all times by all existing enactments on environmental protection and rules made there under, regulations, notifications and byelaws of the State or Central Government, or local authorities and any other law, bye-law, regulations that may be passed or notification that may be issued in future by the State or Central Government or the local authority. Salient features of some of the major laws that are applicable are given below:

- The Water (Prevention and Control of Pollution) Act, 1974, this provides for the prevention and control of water pollution and the maintaining and restoring of wholesomeness of water. 'Pollution' means such contamination of water or such alteration of the physical, chemical or biological properties of water or such discharge of any sewage or trade effluent or of any other liquid, gaseous or solid substance into water (whether directly or indirectly) as may, or is likely to, create a nuisance or render such water harmful or injurious to public health or safety, or to domestic, commercial, industrial, agricultural or other legitimate uses, or to the life and health of animals or plants or of aquatic organisms.
- The Air (Prevention and Control of Pollution) Act, 1981, this provides for prevention, control and abatement of air pollution. 'Air Pollution' means the presence in the atmosphere of any 'air pollutant', which means any solid, liquid or gaseous substance (including noise) present in the atmosphere in such concentration as may be or tend to be injurious to human beings or other living creatures or plants or property or environment.
- The Environment (Protection) Act, 1986, this provides for the protection and improvement of environment and for matters connected therewith, and the prevention of hazards to human beings, other living creatures, plants and property. 'Environment' includes water, air and land and the inter- relationship which exists among and between water, air and land, and human beings, other living creatures, plants, micro-organism and property.
- The Public Liability Insurance Act, 1991, This provides for public liability insurance for the purpose of providing immediate relief to the persons affected by accident occurring while handling hazardous substances and

for matters connected herewith or incidental thereto. Hazardous substance means any substance or preparation which is defined as hazardous substance under the Environment (Protection) Act 1986, and exceeding such quantity as may be specified by notification by the Central Government.

16. The Works and Routine Maintenance to be completed by the Intended Completion Date.

16.1 The Contractor may commence execution of the Works on the Start Date and shall carry out the Works and Routine Maintenance, if specified in the tender, in accordance with the Programme submitted by the Contractor, as updated with the approval of the Engineer, and complete them by the Intended Completion Date.

17. Approval by the Engineer

17.1 The Contractor shall submit Specifications and Drawings showing the proposed Temporary Works to the Engineer, who is to approve them if they comply with the Specifications and Drawings.

17.2 The Contractor shall be responsible for design and safety of Temporary Works.

17.3 The Engineer's approval shall not alter the Contractor's responsibility for design and safety of the Temporary Works.

17.4 The Contractor shall obtain approval of third parties to the design of the Temporary Works, where required.

17.5 All Drawings prepared by the Contractor for the execution of the temporary or permanent Works, are subject to prior approval by the Engineer before their use.

18. Safety

18.1 The Contractor shall be responsible for the safety of all activities on the Site. He shall comply with all applicable safety requirements and take care of safety of all persons entitled to be on the site and the works. He shall use reasonable efforts to keep the site and the works, both during construction and maintenance, clear of unnecessary obstruction so as to avoid danger to the persons and the users.

- Workers employed on mixing asphaltic materials, cement and lime mortars shall be provided with protective footwear and protective goggles.
- Stone breaker shall be provided with protective goggles and protective clothing and seated at sufficiently safe intervals.
- The area should be barricaded or cordoned off by suitable means to avoid mishaps of any kind. Power warning signs should be displayed for the safety of the public whenever cleaning works are undertaken during night

or day.

- The workers engaged for cleaning the manholes/sewers should be properly trained before allowing working in the manhole.

18.2 Safety Programs:-

- I.** Have adequate safety supervision in place to ensure that safety programs set up by the firms/agencies are in compliance with prevalent laws and regulations.
- II.** Review safety programs developed by each of the trade firms, prepare and submit a comprehensive safety program.
- III.** Monitor day to day implementation of safety procedures.

18.3 First Aid Facilities: -

- i. At every work place there shall be provided and maintained, so as to be easily accessible during working hours, first-aid boxes at the rate of not less than one box for 150 contract labour or part thereof ordinarily employed.
- ii. The first-aid box shall be distinctly marked with a red cross on white background.
- iii. Adequate arrangements shall be made for immediate recoument of the equipment when necessary.
- iv. Nothing except the prescribed contents shall be kept in the First-aid box.
- v. The first-aid box shall be kept in charge of a responsible person who shall always be readily available during the working hours of the work place.
- vi. A person in charge of the First-aid box shall be a person trained in First-aid treatment, in the work places where the number of contract labour employed is 150 or more.

19. Discoveries

19.1 Anything of historical or other interest or of significant value unexpectedly discovered on the Site shall be the property of the Employer. The Contractor shall notify the Engineer of such discoveries and carry out the Engineer's instructions for dealing with them.

20. Possession of the Site

20.1 The Employer shall handover complete or part possession of the site to the Contractor 7 days in advance of construction programme. At the start of the work, the Employer shall handover the possession of at least 75% of the site free of all encumbrances, the remaining 25 % of the possession as per contractor's

constructionprogramme.

21. Access to the Site

21.1 The Contractor shall allow access to the Site and to any place where work in connection with the Contract is being carried out, or is intended to be carried out to the Engineer and any person/persons/agency authorized by: a. The Engineer
b. The Employer or authorized by the Employer.

22. Instructions

22.1 The Contractor shall carry out all instructions of the Engineer, which comply with the applicable laws where the Site is located.

22.2 The Contractor shall permit the appointed and/or authorized persons to inspect the Site and/or accounts and records of the Contractor and its subcontractors relating to the performance of the Contract, and to have such accounts and records audited by auditors appointed, if so required. The Contractor's attention is invited to Clause of 'Fraud and Corruption', which provides, inter alia, that acts intended to materially impede the exercise of the inspection and audit rights provided for under the Clause & constitute a obstructive practice subject to contract termination.

22.3 Engineer to have power to issue further drawings or instructions:

The Engineer shall have the power and authority from time to time and at all times to make and issue such further drawings and to give such further instructions and directions as may appear to him necessary or proper for the guidance of the contractor and the good and sufficient execution of the works according to terms of the specifications and Contractor shall receive, execute, obey and be bound by the same, according to the true intent and meaning thereof, as fully and effectually as though the same had accompanied or had been mentioned or referred to in the specification, and the Engineer may also alter or vary the levels or position or nature of works contemplated by the specifications, or may order any of the works contemplated thereby to be omitted, with or without the substitution of any other works in lieu thereof, or may order any work or any portion of work executed or partially executed, to be removed, changed or altered, added if needful, may order that other works shall be substituted instead thereof and difference of expense occasioned by any such diminution or alteration so ordered and directed shall be added to or deducted from the amount of this Contract, as provided under condition no.10(a) hereinafter.

No work which radically changes the original nature of the Contract shall be ordered by the Engineer and in the event of any deviation being ordered which in the opinion of the Contractor changes the original nature of Contract he shall nevertheless carry it out and disagreement as to the nature of the work and the rate to be paid therefore shall be resolved in accordance with condition no.13d.

The time for completion of the Works, shall be in even of any deviations resulting in additional cost over the contract price being ordered, be extended or reduced reasonably by the Engineer. The Engineer's decision in this case shall be final.

B. Time Control

23. Program

23.1 Within the time stated in the Contract Data, the Contractor shall submit to the Engineer for approval a Programme, including Environment Management Plan showing the general methods, arrangements, order, and timing for all the activities in the Works, along with monthly cash flow forecasts for the construction of works.

After the completion of the construction works, the programme for the Routine Maintenance Work, showing the general methods, arrangements, order and timing for all the activities involved in the Routine Maintenance will also be submitted by the Contractor to the Engineer for approval if specified in the tender. The programme for Routine Maintenance will be submitted in each year for the period of Maintenance.

23.2 The Contractor shall submit the list of equipment and machinery being brought to site, the list of key personnel being deployed, the list of machinery/equipments being placed in field laboratory and the location of field laboratory along with the Programme. The Engineer shall cause these details to be verified at each appropriate stage of the programme.

23.3 An update of the Programme shall be a programme showing the actual progress achieved on each activity and the effect of the progress achieved on the timing of the remaining Works, including any changes to the sequence of the activities.

23.4 The Contractor shall submit to the Engineer for approval an updated Programme at intervals no longer than the period stated in the Contract Data. If the Contractor does not submit an updated Programme within this period, the Engineer may withhold the amount stated in the Contract Data from the next payment certificate and continue to withhold this amount until the next payment after the date on which the overdue Programme has been submitted.

23.5 The Engineer's approval of the Programme shall not alter the Contractor's obligations. The Contractor may revise the Programme and submit it to the Engineer again at any time. A revised Programme shall show the effect of Variations and Compensation Events.

24. Extension Of Time In Contracts :

Subject to any requirement in the contract as to completion of any portions or portions of the works before completion of the whole, the contractor shall fully and finally complete the whole of the works comprised in the contract (with such modifications as may be directed under conditions of this contract) by the date entered in the contract or extended date in terms of the following clauses:

a) **Extension attributable to BMC**

- i. **Extension Due To Modification:** If any modifications have been ordered which in the opinion of the Engineer have materially increased the magnitude of the work, then such extension of the contracted date of completion may be granted as shall appear to the Engineer to be reasonable in the circumstances, provided moreover that the Contractor shall be responsible for requesting such extension of the date as may be considered necessary as soon as the cause thereof shall arise and in any case **should not be less than 30 days before the expiry of the date fixed for completion of the works.**
- ii. **Extension For Delay Due To BMC:** In the event of any failure or delay by the BMC to hand over the Contractor possession of the lands necessary for the execution of the works or to give the necessary notice to commence the works or to provide the necessary drawings or instructions or any other delay caused by the BMC due to any other cause whatsoever, then such failure or delay shall in no way affect or vitiate the contract or alter the character thereof or entitle the contractor to damages or compensation therefore, but in any such case, the BMC may grant such extension(s) of the completion date as may be considered reasonable.

Note: For extension of time period as governed in (i) and (ii) above, any modifications in design/drawings, specifications, quantities shall be needed to be justified with recorded reasons with approval of Ch.Eng. for not anticipating the same while preparing estimates and draft tender.

- b) **Extension of Time For Delay Due To Contractor:** The time for the execution of the work or part of the works specified in the contract documents shall be deemed to be the essence of the contract and the works must be completed no later than the date(s) / the programme for completion of work as specified in the contract. If the contractor fails to complete the works within the time as specified in the contract for the reasons other than the reasons specified in above as (a.i) and (a.ii), the BMC may, if satisfied that the works can be completed by the contractor within reasonable short time thereafter, allow the contractor for further extension of time as the Engineer may decide. On such extension the BMC will be entitled without prejudice to any other right and remedy available on that behalf, to recover the compensation as governed by

Clause 8(e) of GCC.

For the purpose of this Clause, the contract value of the works shall be taken as value of work as per contract agreement including any supplementary work order/contract agreement issued

Further, competent authority while granting extension to the currency of contract under Clause (b) of as above may also consider levy of penalty, as deemed fit based on the merit of the case. Also, the reasons for granting extension shall be properly documented

25. Delays Ordered by the Engineer

25.1 The Engineer may instruct the Contractor to delay the start or progress of any activity within the Works. Delay/delays totaling more than 30 days will require prior written approval of the DMC/AMC.

26. Management Meetings

26.1 The Engineer may require the Contractor to attend a management meeting. The business of a management meeting shall be to review the plans for progress of the Works.

26.2 The Engineer shall record the business of management meetings and provide copies of the record to those attending the meeting. The responsibility of the parties for actions to be taken shall be decided by the Engineer either at the management meeting or after the management meeting and stated in writing to all those who attended the meeting.

C. Quality Control

27.

27.1 Work to be open to Inspection and Contractor or Responsible agent to be present

All works under or in course of execution or executed in pursuance of the contract shall at all times be open to the inspection and supervision of the Eng-in-charge and his subordinates and the contractor shall at all times during the usual working hours, at all other times, during the usual working hours and at all other times at which reasonable notice of the intention of the Eng-in-charge and his subordinates to visit the works shall have been given to the contractor, either himself be present to receive orders and instruction or have responsible agent duly accredited in writing present for that purpose. Order given to the contractors' duly authorized agent shall be considered to have the same force and effect as if they had been given to the contractor himself.

27.2 Notice To Be Given Before Work Is Covered Up

The contractor shall give not less than ten days' notice in writing to the Eng-In-Charge or his subordinate in-charge of the work before covering up or otherwise placing beyond the reach of measurement any work in order that the same may be measured and correct dimension thereof taken before the same is so covered up or placed beyond the reach of measurements and shall not cover up or place beyond the reach of measurement any work without the consent in writing of the Eng-In-Charge or his subordinate in-charge of the work, and if any work shall be covered up or placed beyond the reach of measurement, without such notice having been given or consent obtained the same shall be uncovered at the contractor's expenses, and in default thereof no payment or allowance shall be made for such work or for the materials with which the same was executed.

27.3 Works to be executed in accordance with specifications / drawings / orders etc. :

The contractor shall execute the whole and every part of the work in the most substantial and workman-like manner and both as regards material and every other respect in strict accordance with specifications. The contractor shall also conform exactly, fully and faithfully to the designs, drawings and instructions in writing relating to the work signed by the Engineer In-charge and lodged in his office and to which the contractor shall be entitled to have access for the purpose of inspection at such office, or on the site or work during office hours. The contractor shall be entitled to receive three sets of contract drawings and working drawings as well as one certified copy of the accepted tender along with the work order free of cost.

27.4 Ready Mix Concrete/ Asphalt Mix

- (i) The contractor shall have to arrange Ready Mix concrete (RMC)/Asphalt from RMC/ASPHALT producing plants registered with BMC.
- (ii) The contractor shall, within 7 days of award of the work, submit a list of at least three RMC/Asphalt producers with details of such plants including details and number of transit, mixers & pumps etc. to be deployed indicating name of owner/company, its location, capacity, technical establishment.

The Engineer-in-charge will reserve the right to inspect at any stage and reject the concrete if he is not satisfied about the quality of product at the user's end.

- (iii) The Engineer-in-charge reserves the right to exercise control over the:-
 - a) Calibration check of the RMC/Asphalt plant.
 - b) Weight and quantity check on the ingredients, water and admixtures

added for batch mixing for RMC plants

- c) Time of mixing of concrete/grade of asphalt.
- d) Testing of fresh concrete/asphalt mix, recording of results and declaring the mix fit or unfit for use. This will include continuous control on the work ability during production and taking corrective action, if required.
- e) For exercising such control, the Engineer-in-charge shall periodically depute his authorized representative at the RMC/Asphalt plant. It shall be responsibility of the contractor to ensure that all necessary equipment, manpower & facilities are made available to Engineer-in-charge and or his authorized representative at RMC/Asphalt plant.
- f) All required relevant records of RMC/Asphalt mix shall be made available to the Engineer-in-charge or his authorized representative. Engineer-in-charge shall, as required, specify guidelines & additional procedures for quality control & other parameters in respect of material production & transportation of concrete mix which shall be binding on the contractor & the RMC/Asphalt plant. Only concrete as approved in design mix by Engineer- in-charge shall be produced in RMC plant and transported to the site.
- g) The contractor shall have to produce a copy of challan receipts/SCADA reports/VTS reports as issued by the RMC/Asphalt plant as a documentary proof in lieu of supply of RMC/Asphalt mix before releasing payment.

28. Identifying Defects

- 28.1 The Engineer shall check the Contractor's work and notify the Contractor of any Defects that are found. Such checking shall not affect the Contractor's responsibilities. The Engineer may instruct the Contractor to search for a Defect and to uncover and test any work that the Engineer considers may have a Defect.
- 28.2 The Contractor shall permit the Employer's technical person(s) to check the Contractor's work and notify the Engineer and Contractor if any defects that are found.

29. Tests

- 29.1 For carrying out mandatory tests as prescribed in the specifications, the Contractor shall establish field laboratory at the location decided by Engineer. The field laboratory will have minimum of equipments as specified in the Contract Data. The contractor shall be solely responsible for:

- a. Carrying out the mandatory tests prescribed in the Specifications, and
- b. For the correctness of the test results, whether performed in his laboratory or elsewhere.

29.2 If the Engineer instructs the Contractor to carry out a test not specified in the Specification/ Quality Assurance Handbook to check whether any work has a Defect and the test shows that it does, the Contractor shall pay for the test and any samples. If there is no defect, the test shall be a compensation event.

When required by the Engineer-in-charge the contractor(s) shall supply for the purpose of testing samples of all materials proposed to be used in the works. Samples submitted either to govern bulk supplies or required for testing before use shall be in suitable packages to contain them and shall be provided free of charge by the contractor. The cost of testing shall be borne by the contractor even if the result of the sample confirm or do not confirm to the relevant BIS code specifications.

- i. All expenditure required to be incurred for taking the samples conveyance, packing shall be borne by the contractor himself.
- ii. The failed material shall be removed from the site by the contractor at his own cost within a week time of written order of the Engineer-in-charge.

29.3 Setting of Site Laboratories (Applicable for works costing more than Rs,5 Crores:

Contractors shall set up a laboratory at site before commencement of work at their cost for performing various tests and at least the following machines and equipments shall be provided therein –

- 1) Set of Sieves as per I.R.C. /I.S.
- 2) Compressive Testing Machine(For new works)
- 3) Oven, Electrically Operated
- 4) Weighing Balance (20 kg capacity)
- 5) 3 m straight edge
- 6) Sieve shaker
- 7) First Aid Box
- 8) Measuring Jar (for silt content)
- 9) Other Machines/apparatus as may be directed by the Engineer
- 10) Vernier Caliber
- 11)Level / Theodolite

All the test records shall be maintained in the site office and made available as and when required. The laboratory must be established within 15 days from the date of

receipt of the orders from Engineer In charge. On failure to do so, a penalty of Rs 1000/- per day shall be imposed.

The contractor shall install testing equipment at site. The contractor shall ensure and certify the calibration of the equipment so installed and shall maintain the same in working order throughout the period of construction. The contractor shall also provide necessary technically qualified experienced trained staff for carrying out such tests for using such equipment. The tests shall be carried out under the supervision of the Engineer-in-charge. The calibration shall be checked every twelve months as directed by Engineer-in-charge.

30. Correction of Defects noticed during the Defects Liability Period.

- a) The Engineer shall give notice to the Contractor of any Defects before the end of the Defects Liability Period, which begins at Completion and ends after five years. The Defects Liability Period shall be extended for as long as Defects remain to be corrected.
- b) Every time notice of Defect/Defects is given, the Contractor shall correct the notified Defect/Defects within the duration of time specified by the Engineer's notice.
- c) The Engineer may issue notice to the Contractor to carry out removal of defects or deficiencies, if any, noticed in his inspection, or brought to his notice. The Contractor shall remove the defects and deficiencies within the period specified in the notice and submit to the Engineer a compliance report.

31. Uncorrected Defects and Deficiencies

31.1 If the Contractor has not corrected a Defect pertaining to the Defect Liability Period under clause and deficiencies in maintenance, to the satisfaction of the Engineer, within the time specified in the Engineer's notice, the Engineer will assess the cost of having the Defect or deficiency corrected, and the Contractor shall pay this amount, on correction of the Defect or deficiency by another agency.

C. Cost Control

32. Variations

The Engineer shall, having regard to the scope of the Works and the sanctioned estimated cost, have power to order, in writing, Variations within the scope of the Works he considers necessary or advisable during the progress of the Works. Such Variations shall form part of the Contract and the Contractor shall carry them out and include them in updated Programmes produced by the Contractor. Oral orders of the Engineer for Variations, unless followed by written confirmation, shall not be taken into account.

33. Payments for Variations

35.1 If rates for Variation items are specified in the Bill of Quantities, the Contractor shall carry out such work at the same rate.

35.2 The rate for Extra/Excess shall be governed by clause 10.A of Standard General Condition of Contract.

34. Cash Flow Forecasts

When the Programme is updated, the Contractor shall provide the Engineer with an updated cash flow forecast.

35. Payment Certificates

The payment to the Contractor will be as follows for construction work:

- a) A bill shall be submitted by the Contractor monthly or before the date fixed by the Engineer In-charge for all works executed in the previous month, and the Engineer In-charge shall take or cause to be taken requisite measurement for the purpose of having the same verified and the claim, so far as it is admissible, shall be adjusted, if possible, within 10 days from the presentation of the bill. If the contractor does not submit the bill within the time fixed as aforesaid, the Engineer In-charge may depute a subordinate to measure up the said work in the presence of the contractor or his duly authorized agent whose counter signature to the measurement list shall be sufficient warrant, and Engineer In-Charge may prepare a bill from such list which shall be binding on the contractor in all respects.
- b) The Engineer shall check the Contractor's fortnightly/monthly statement within 14 days and certify the amount to be paid to the Contractor.
- c) The value of work executed shall be determined, based on measurements by the Engineer.
- d) The value of work executed shall comprise the value of the quantities of the items in the Bill of Quantities completed.
- e) The value of work executed shall also include the valuation of Variations and CompensationEvents.
- f) The Engineer may exclude any item certified in a previous certificate or reduce the proportion of any item previously certified in any certificate in the light of later information. (g) The contractor shall submit all bills on the printed forms at the office of Engineer In- charge. The charges to be made in the bills shall always be entered at the rates specified in tender.

36. Payments

- 36.1 Payments shall be adjusted for deductions for advance payments, retention, security deposit, other recoveries in terms of the Contract and taxes at source, as applicable under the law. The Employer shall pay the Contractor the amounts certified by the Engineer within 15 days of the date of each certificate.
- 36.2 All sums payable by a contractor by way of compensation under any of these conditions, shall be considered as a reasonable compensation to be applied to the use of BMC without reference to the actual loss or damage sustained and whether any damage has or has not been sustained.
- 36.3 No payment shall be made for any work estimated to cost less than Rupees One Thousand till after the whole of work shall have been completed and the certificate of completion given. But in the case of works estimated to cost more than Rs. One Thousand, the contractor shall on submitting a monthly bill therefore be entitled to receive payment proportionate to the part of the work than approved and passed by the Engineer In-charge, whose certificate of such approval and passing of the sum so payable shall be final and conclusive against the contractor. All such intermediate payments shall be regarded as payments by way of advance against the final payments only and not as payments for work actual done and completed and shall not preclude the Engineer In-charge from requiring any bad, unsound, imperfect or unskillful work to be removed or taken away and reconstructed or re-erected nor shall any such payment be considered as an admission of the due performance of the contract or any part thereof in any respect or the offering of any claim not shall it conclude, determine or effect in any other way, the powers of the Engineer In-charge as to the final settlement and adjustment of the accounts or otherwise, or in any other way vary or effect the contract. The final bill shall be submitted by the Contractor within one month of the date fixed for the completion of the work otherwise the Engineer In-charge's certificate of the measurements and of the total amount payable for the work shall be final and binding on all parties.
37. The Contractor shall not be entitled to compensation to the extent that the Employer's interests are adversely affected by the Contractor for not having given early warning or not having cooperated with the Engineer.

38. Tax

G.S.T. and other state levies/cess which are not subsumed under GST will be applicable. The tenderer shall quote inclusive of all taxes. It is clearly understood that BMC will not bear any additional liability towards payment of any Taxes & Duties.

Whenever the services to be provided by the Tenderers falls under Reverse

Charge Mechanism, the Price quoted shall be exclusive of GST, but inclusive of Taxes/Duties/ Cess other than GST, if any.

Rates accepted by BMC shall hold good till completion of work and no additional individual claim shall be admissible on account of fluctuations in market rates; increase in taxes / any other levies/ tolls etc. except that payment/ recovery for overall market situation shall be made as per price Variation

39. Currencies

All payments will be made in Indian Rupees.

40. Liquidated Damages

Both, the Contractor and the Employer have agreed that it is not feasible to precisely estimate the amount of losses due to delay in completion of works and the losses to the public and the economy, therefore, both the parties have agreed that the Contractor shall pay liquidated damages to the Employer and not by way of penalty, at the rate per week or part thereof stated in the Contract Data for the period that the Completion Date is later than the Intended Completion Date. Liquidated damages at the same rates shall be withheld if the Contractor fails to achieve the milestones prescribed in the Contract Data. However, in case the Contractor achieves the next milestone, the amount of the liquidated damages already withheld shall be restored to the Contractor by adjustment in the next payment certificate. The Employer and the contractor have agreed that this is a reasonable agreed amount of liquidated damage. The Employer may deduct liquidated damages from payments due to the Contractor. Payment of liquidated damages shall not affect the Contractor's other liabilities.

41. Cost of Repairs

Loss or damage to the Works or Materials to be incorporated in the Works between the Start Date and the end of the Defects Correction periods shall be remedied by the Contractor at his cost if the loss or damage arises from the Contractor's acts or omissions.

E. Finishing the Contract

42. Completion of Construction and Maintenance

42.1 The Contractor shall request the Engineer to issue a certificate of completion of the construction of the works, and the Engineer will do so upon deciding that the

works is completed. This shall be governed as per clause no.8(g) of Standard General Conditions of Contract.

43. Taking Over

43.1 The Employer shall take over the works within seven days of the Engineer issuing a certificate of completion of works. The Contractor shall continue to remain responsible for its routine maintenance during the maintenance period if specified in the contract.

44. Final Account

Final joint measurement along with the representatives of the contractor should be taken recorded and signed by the Contractors. Contractors should submit the final bill within 1 month of physical completion of the work.

If the contractor fails to submit the final bill within 1 month, the BMCstaff will prepare the final bill based on the joint measurement within next 3 months.

Engineer's decision shall be final in respect of claims for defect and pending claims against contractors.

No further claims should be made by the Contractor after submission of the final bill and these shall be deemed to have been waived and extinguished. Payment of those items of the bills in respect of which there is no dispute and of items in dispute, for quantities and rates as approved by the Commissioner shall be made within a reasonable period as may be necessary for the purpose of verification etc.

After payment of the final bill as aforesaid has been made, the contractor may, if he so desires, reconsider his position in respect of a disputed portion of the final bills and if he fails to do so within 84 days, his disputed claim shall be dealt with as provided in the contract.

A percentage of the retention money, over and above the actual retention money as indicated below shall be held back from payments till the finalization of final bill to be submitted as per above and will be paid within 30 days of acceptance of the final bill.

Sr.No	Amount of Contract Cost	Minimum Payable Amount in final bill
1	Upto Rs.5 Crores	Rs.10 Lacs or final bill amount whichever is more
2	Upto Rs.25 Crores	Rs.1 Crore or final bill amount whichever is more
3	Upto Rs.50 Crores	Rs.2 Crore or final bill amount whichever is more
4	Upto Rs.100 Crores	Rs.4 Crore or final bill amount whichever is more
5	More than Rs.100 Crores	Rs.7 Crore or final bill amount whichever is more

The contractor have to submit the bill for the work carried out within 15 days from the date of completion of the work to the respective executing department. If the

contractor fails to submit their bills to concerned executing department, penalty or action as shown below will be taken for each delayed bill:-

After 15 days from the date of completion/running bill upto certain date, upto to next 15 days i.e. upto 30 days.	Equal to 5 % of bill amount.
Next 15 days upto 45 days from the date of completion/running bill upto specified date.	Equal to 10 % of bill amount
If not submitted within 45 days from the date of completion/RA Bill	Bill will not be admitted for payment.

45. Operating and Maintenance Manuals

- 45.1 If "as built" Drawings and/or operating and maintenance manuals are required, the Contractor shall supply them by the dates stated in the Contract Data.
- 45.2 If the Contractor does not supply the Drawings and/or manuals by the dates stated in the Contract Data, or they do not receive the Engineer's approval, the Engineer shall withhold the amount stated in the Contract Data from payments due to the Contractor.

46. Termination

- 46.1 The Employer or the Contractor may terminate the Contract if the other party causes a fundamental breach of the Contract.
- 46.2 Fundamental breaches of Contract shall include, but shall not be limited to, the following:
- a) the Contractor stops work for 30 days when no stoppage of work is shown on the current Programme and the stoppage has not been authorized by the Engineer;
 - b) the Contractor is declared as bankrupt or goes into liquidation other than for approved reconstruction or amalgamation;
 - c) the Engineer gives Notice that failure to correct a particular Defect is a fundamental breach of Contract and the Contractor fails to correct it within a reasonable period of time determined by the Engineer;
 - d) the Contractor does not maintain a Security, which is required;
 - e) the Contractor has delayed the completion of the Works by the number of days for which the maximum amount of liquidated damages can be paid, as defined in relevant clause.
 - f) the Contractor fails to provide insurance cover as required under relevant

clause.

- g) if the Contractor, in the judgment of the Employer, has engaged in the corrupt or fraudulent practices as defined in GCC in competing for or in executing the Contract.
- h) if the Contractor fails to set up a field laboratory with the prescribed equipment, within the period specified in the Contract Data; and
- i) any other fundamental breaches as specified in the Contract Data.
- j) if the Contractor fails to deploy machinery and equipment or personnel as specified in the Contract Data at the appropriate time.

46.3 When either party to the contract gives notice of a breach of contract to the Engineer for a cause other than those listed above, the Engineer shall decide whether the breach is fundamental or not.

46.4 Notwithstanding the above, the Employer may terminate the Contract for convenience.

46.5 If the Contract is terminated, the Contractor shall stop work immediately, make the Site safe and secure, and leave the Site as soon as reasonably possible.

47. Payment upon Termination

47.1 If the Contract is terminated because of a fundamental breach of Contract by the Contractor, the Engineer shall issue a certificate for value of the work done and materials ordered less liquidated damages, if any, less advance payments received up to the date of the issue of the certificate and less the percentage to apply to the value of the work not completed, as indicated in the Contract Data. If the total amount due to the Employer exceeds any payment due to the Contractor, the difference shall be recovered from the security deposit, and performance security. If any amount is still left un-recovered it will be a debt due from the Contractor to the Employer.

47.2 If the Contract is terminated at the Employer's convenience, the Engineer shall issue a certificate for the value of the work done, the reasonable cost of removal of Equipment, repatriation of the Contractor's personnel employed solely on the Works, and the Contractor's costs of protecting and securing the Works and less advance payments received up to the date of the certificate, less other recoveries due in terms of the Contract, and less taxes due to be deducted at source as per applicable law.

48. Property

48.1 All Materials on the Site, Plant, Equipment, Temporary Works, and Works shall be deemed to be the property of the Employer for use for completing balance construction work if the Contract is terminated because of the Contractor's

default, till the Works is completed after which it will be transferred to the Contractor and credit, if any, given for its use.

49. Release from Performance

If the Contract is frustrated by the outbreak of war or by any other event entirely outside the control of the Employer or the Contractor, the Engineer shall certify that the Contract has been frustrated. The Contractor shall make the Site safe and stop work as quickly as possible after receiving this certificate and shall be paid for all work carried out before receiving it and for any work carried out afterwards to which a commitment was made.

F. Other Conditions of Contract

50. Labour

50.1 The Contractor shall, unless otherwise provided in the Contract, make his own arrangements for the engagement of all staff and labour, local or other, and for their payment, housing, feeding and transport.

50.2 The Contractor shall, if required by the Engineer, deliver to the Engineer a return in detail, in such form and at such intervals as the Engineer may prescribe, showing the staff and the number of the several classes of labour from time to time employed by the Contractor on the Site and such other information as the Engineer may require.

51. Compliance with Labour Regulations

- a) During continuance of the Contract, the Contractor and his sub-Contractors shall abide at all times by all existing labour enactments and rules made there under, regulations, notifications and bye laws of the State or Central Government or local authority and any other labour law (including rules), regulations, bye laws that may be passed or notification that may be issued under any labour law in future either by the State or the Central Government or the local authority.
- b) Furthermore, the Contractor shall keep the Employer indemnified in case any action is taken against the Employer by the competent authority on account of contravention of any of the provisions of any Act or rules made there under, regulations or notifications including amendments. If the Employer is caused to pay or reimburse, such amounts as may be necessary to cause or observe, or for non-observance of the provisions stipulated in the notifications/bye laws/Acts/Rules/regulations including amendments, if any, on the part of the Contractor, the Engineer/Employer shall have the right to deduct any money due to the Contractor including his amount of performance guarantee. The Employer/Engineer shall also have right to recover from the Contractor any sum required or estimated to be required for making good the loss or damage

suffered by the Employer.

- c) The Contractor shall require his employees to obey all applicable laws, including those concerning safety at work.
- d) The employees of the Contractor and the Sub-Contractor in no case shall be treated as the employees of the Employer at any point of time.

52. Drawings and Photographs of the Works

52.1 The Contractor shall do photography/video photography of the site firstly before the start of the work, secondly mid-way in the execution of different stages of work as required by Engineer In-charge and lastly after the completion of the work. No separate payment will be made to the Contractor for this.

52.2 The Contractor shall not disclose details of Drawings furnished to him and works on which he is engaged without the prior approval of the Engineer in writing. No photograph of the works or any part thereof or plant employed thereon, except those permitted under above clause, shall be taken or permitted by the Contractor to be taken by any of his employees or any employees of his sub-Contractors without the prior approval of the Engineer in writing. No photographs/ Video photography shall be published or otherwise circulated without the approval of the Engineer in writing.

53. The Apprentices Act, 1961

The Contractor shall duly comply with the provisions of the Apprentices Act 1961 (III of 1961), the rules made there under and the orders that may be issued from time to time under the said Act and the said Rules and on his failure or neglect to do so, he shall be subject to all liabilities and penalties provided by the said Act and said Rules.

54. Contract Document

The documents forming the contract are to be taken as mutually explanatory of one another. Unless otherwise provided in the contract, the priority of the documents forming the contract shall be, as follows:

- 1) Contract Agreement (if completed)
- 2) The letter of Acceptance
- 3) The Bid:
- 4) Addendum to Bid; if any
- 5) Tender Document
- 6) The Bill of Quantities:
- 7) The Specification:
- 8) Detailed Engineering Drawings

- 9) Standard General Conditions of Contracts (GCC)
- 10) All correspondence documents between bidder/contractor and BMC.

55. Conflict of Interest

The Applicant shall not have a conflict of interest (the "Conflict of Interest") that affects the Bidding Process. Any Applicant found to have a Conflict of Interest shall be disqualified. An Applicant shall be deemed to have a Conflict of Interest affecting the Bidding Process, if

- 1) A constituent of such Applicant is also a constituent of another Applicant; or
- 2) Such Applicant has the same legal representative for purposes of this Application as any other Applicant; or
- 3) Such Applicant, or any Associate thereof has a relationship with another Applicant, or any Associate thereof, directly or through common third party/ parties, that puts either or both of them in a position to have access to each other's information about, or to influence the Application of either or each other; or
- 4) The Applicant shall be liable for disqualification if any legal, financial or technical adviser of the Authority in relation to the Project is engaged by the Applicant, its Member or any Associate thereof, as the case may be, in any manner for matters related to or incidental to the Project. For the avoidance of doubt, this disqualification shall not apply where such adviser was engaged by the Applicant, its Member or Associate in the past but its assignment expired or was terminated 6 (six) months prior to the date of issue of this TENDER. Nor will this disqualification apply where such adviser is engaged after a period of 3 (three) years from the date of commercial operation of the Project.

56. Applications and costs thereof

No Applicant shall submit more than one Application for the Project. An applicant applying individually shall not be entitled to submit another application either individually. The Applicant shall be responsible for all of the costs associated with the preparation of their Applications and their participation in the Bid Process. The Authority will not be responsible or in any way liable for such costs, regardless of the conduct or outcome of the Bidding Process.

57. Acknowledgment by Applicant

It shall be deemed that by submitting the Application, the Applicant has:

- a. made a complete and careful examination of the tender;
- b. received all relevant information requested from the Authority;
- c. accepted the risk of inadequacy, error or mistake in the information provided in

the tender or furnished by or on behalf of the Authority relating to any of the matters referred; and

- d. Agreed to be bound by the undertakings provided by it under and in terms hereof

“The Authority” shall not be liable for any omission, mistake or error in respect of any of the above or on account of any matter or thing arising out of or concerning or relating to the TENDER or the Bidding Process, including any error or mistake therein or in any information or data given by the Authority.

58. Right to accept or reject any or all Applications/ Bids

Notwithstanding anything contained in this TENDER, “The Authority” reserves the right to accept or reject any Application and to annul the Bidding Process and reject all Applications/ Bids, at any time without any liability or any obligation for such acceptance, rejection or annulment, and without assigning any reasons therefore. In the event that the Authority rejects or annuls all the Bids, it may, in its discretion, invite all eligible Bidders to submit fresh Bids hereunder.

“The Authority” reserves the right to reject any Application and/ or Bid if:

- (a) at any time, a material misrepresentation is made or uncovered, or
- (b) the Applicant does not provide, within the time specified by the Authority, the supplemental information sought by the Authority for evaluation of the Application.

In case it is found during the evaluation or at any time before signing of the Agreement or after its execution and during the period of subsistence thereof including the concession thereby granted by “The Authority”, that one or more of the pre-qualification conditions have not been met by the Applicant, or the Applicant has made material misrepresentation or has given any materially incorrect or false information, the Applicant shall be disqualified forthwith if not yet appointed as the Successful Bidder either by issue of the LOA (Letter of Approval) or entering into of the Agreement, and if the Applicant has already been issued the LOA or has entered into the Concession Agreement, as the case may be, the same shall, notwithstanding anything to the contrary contained therein or in this TENDER, be liable to be terminated, by a communication in writing by “The Authority” to the Applicant, without the Authority being liable in any manner whatsoever to the Applicant and without prejudice to any other right or remedy which the Authority may have under this TENDER, the Bidding Documents, the Concession Agreement or under applicable law. “The Authority” reserves the right to verify all statements, information and documents submitted by the Applicant in response to the TENDER. Any such verification or lack of such verification by the Authority shall not relieve the Applicant of its obligations or liabilities hereunder nor will it affect any rights of the Authority there under.

59. The bid shall be rejected if the bidder-

- a) Stipulates the validity period less than 180 days.
- b) Stipulates own condition/conditions.
- c) Does not fill and (digital) sign undertaking forms, which are incorporated, in the document.

60. Clarifications

Applicants requiring any clarification on the tender may notify “the Authority” in writing or by fax or e-mail. They should send in their queries before the date specified in the header data. “The Authority” shall Endeavor to respond to the queries within the period specified therein. The responses will be sent by fax and/or e-mail. The Authority will forward all the queries and its responses thereto, to all purchasers of the TENDER without identifying the source of queries.

“The Authority” shall Endeavor to respond to the questions raised or clarifications sought by the Applicants. However, the Authority reserves the right not to respond to any question or provide any clarification, in its sole discretion, and nothing in this Clause shall be taken or read as compelling or requiring the Authority to respond to any question or to provide any clarification, but not later than the date provided in header data.

“The Authority” may also on its own motion, if deemed necessary, issue interpretations and clarifications to all Applicants. All clarifications and interpretations issued by the Authority shall be deemed to be part of the tender. Verbal clarifications and information given by Authority or its employees or representatives shall not in any way or manner be binding on the Authority.

61. Amendment of tender:At any time prior to the deadline for submission of Application, the Authority may, for any reason, whether at its own initiative or in response to clarifications requested by an Applicant, modify the tender by the issuance of Addendum.

Any Addendum thus issued will be sent in writing/ Fax/ Email to all those who have purchased the tender.

In order to afford the Applicants a reasonable time for taking an Addendum into account, or for any other reason, the Authority may, in its sole discretion, extend the Application Due Date.

Preparation and Submission of Application

62. Language

The Application and all related correspondence and documents in relation to the

Bidding Process shall be in English language. Supporting documents and printed literature furnished by the Applicant with the Application may be in any other language provided that they are accompanied by translations of all the pertinent passages in the English language, duly authenticated and certified by the Applicant. Supporting materials, which are not translated into English, may not be considered. For the purpose of interpretation and evaluation of the Application, the English language translation shall prevail.

63. Format and signing of Application

The Applicant shall provide all the information sought under this TENDER. The Authority will evaluate only those Applications that are received in the required formats and complete in all respects. Incomplete and /or conditional Applications shall be liable to rejection.

The Applicant will upload bid in One Folder in electronic form which shall contain the scanned certified copies of the documents given below and the documents uploaded has to be digitally signed by the bidder. These copies shall be certified by Practicing Notary approved by the Govt. of Maharashtra or Govt. of India with his stamp, clearly stating his name & registration number, except where original documents are demanded.

64. Marking of Applications

The Applicant shall submit the Application in the format specified at Appendix-I, together with the documents, upload in folder as "VENDOR" together with their respective enclosures

Applications submitted by fax, telex, telegram shall not be entertained and shall be rejected outright.

65. Late Applications

Applications received by the Authority after the specified time on the Application Due Date shall not be eligible for consideration and shall be summarily rejected.

66. Confidentiality

Information relating to the examination, clarification, evaluation, and recommendation for the short-listed qualified Applicants shall not be disclosed to any person who is not officially concerned with the process or is not a retained professional advisor advising the Authority in relation to or matters arising out of, or concerning the Bidding Process. The Authority will treat all information, submitted as part of Application, in confidence and will require all those who have access to such material to treat the same in confidence. The Authority may not divulge any such information unless it is directed to do so by any statutory entity that has the power under law to require its disclosure or is to enforce or assert any right or privilege of the statutory entity and/ or the Authority

or as may be required by law or in connection with any legal process.

67. Clarification Of Financial Bids

To assist in the examination, evaluation and comparison of Bids, the Engineer may, at his discretion, ask any bidder for clarification of his Bid, including breakdown of unit rates. The request for clarification and the response shall be in writing or by post/facsimile/e- mail. No Bidder shall contact the Engineer on any matter relating to his bid from the time of the bid opening to the time the contract is awarded. Any effort by the Bidder to influence the Engineer in the Engineer's bid evaluation, bid comparison or contract award decisions may result in the rejection of the Bidder's bid.

68. Inspection of site and sufficiency of tender:

- 1) The Contractor shall inspect and examine the site and its surrounding and shall satisfy himself before submitting his tender as to the nature of the ground and subsoil (so far as is practicable), the form and nature of the site, the quantities and nature of the work and materials necessary for the completion of the works and means of access to the site, the accommodation he may require and in general shall himself obtain all necessary information as to risk, contingencies and other circumstances which may influence or affect his tender. He shall also take into consideration the hydrological and climatic conditions.
- 2) The Employer may make available to the Contractor data on hydrological and sub- surface conditions as obtained by or on his behalf from investigations relevant to the works but the Contractor shall be responsible for his own interpretation thereof. The contractor shall engage his investigating agency with prior approval of the Engineer from the approved list of such agencies by BMCorGovt at his cost initially before commencing actual work and which shall be reimbursed immediately subject to satisfaction of the Engineer for faithful compliance and submission of required data regarding such investigation within specified time.
- 3) The Contractor shall be deemed to have satisfied himself before tendering as to the correctness and sufficiency of his tender for the works and of the rates and prices quoted in the schedule of works / items / quantities, or in Bill of Quantities, which rates and prices shall, except as otherwise provided cover all his obligations under the Contract and all matters and things necessary for proper completion and maintenance of the works. No extra charges consequent on any misunderstanding.
- 4) **Not Foreseeable Physical Obstructions or Conditions:** If, however, during the execution of the Works the Contractor encounters physical obstructions or physical conditions, other than climatic conditions on the Site, which obstructions or conditions were, in his opinion, not foreseeable by an experienced contractor, the Contractor shall forthwith give notice thereof to the

Engineer. On receipt of such notice, the Engineer shall, if in his opinion such obstructions or conditions could not have been reasonably foreseen by an experienced contractor, after due consultation with the Contractor, determine:

- any extension of time to which the Contractor is entitled and
- The amount of any costs which may have been incurred by the Contractor by reason of such obstructions or conditions having been encountered, which shall be added to the Contract Price.
- and shall notify the Contractor accordingly. Such determination shall take account of any instruction which the Engineer may issue to the Contractor in connection therewith, and any proper and reasonable measures acceptable to the Engineer which the Contractor may take in the absence of specific instructions from the Engineer. However such costing shall be got approved by the competent authority as governed vide rules prevailing with authority.

5) **Office for the Engineer (Works costing upto Rs.50 Lakhs)**

The Contractor shall at his own cost and to satisfaction of the Engineer provide a small temporary office, at the work-site which will include tables, chairs and lockers for keeping the records. He shall also make necessary arrangements for drinking water, telephone with a pre-requisite of e-governance and electronic communication. These offices are not to be allowed on public roads without the written instruction of the Engineer. These offices should be preferably located within 50 to 500 m of the worksite. In case the office is more than 500m away from the worksite, the contractor is to provide conveyance for Municipal Staff.

6) **Office for the Engineer (Works costing above Rs.50 lakhs)**

The Contractor shall at his own cost and to satisfaction of the Engineer provide a temporary office at the work-site which will include tables, chairs and lockers for keeping the records. He shall also make necessary arrangements for drinking water, latrines, with doors, windows, locks, bolts and fastenings sufficient for security for the Engineer, and his subordinates, as close to the works from time to time in progress as can be conveniently arranged, and shall at his own cost furnish the office with such chairs, tables, lockers, locks and fastenings as may be required by the Engineer, and no expense of any kind in connection with the erection or upkeep of the offices or fittings shall be borne by the Corporation, but all such work shall be carried out by the Contractor and the expenses thereof defrayed by him. The Contractor shall also make water connections and fit up stand pipe with a bib tap at each office. The latrines and the water connections shall be subject to all the conditions herein elsewhere laid down for temporary water connection and latrines generally with all requisite equipments for e-governance and electronic and digital

communication. These offices are not to be allowed on public roads without the written instruction of the Engineer. These offices should be preferably located within 50 to 500 m of the worksite. In case the office is more than 500m away from the worksite, the contractor is to provide conveyance. Also, for staff working beyond working hours the contractor has to provide conveyance.

7) Permission for provision and removal of office on completion of work:

The tenderer shall obtain permission for provision of site office, cement go-down, store, etc. on payment of necessary cost implication. The cement go-down, Watchman cabins, etc. shall be provided as directed and shall be removed by the Tenderers on completion of the work at their cost. It is binding on the Tenderer to fulfill requirements of Environmental Authorities. The location of such office shall be finalized and got approved from the Engineer before erection/commencement work.

8) Contractor's office near works:

The Contractor shall have an office near the works at which notice from the Commissioner or the Engineer may be served and shall, between the hours of sunrise and sunset on all working days, have a clerk or some other authorized person always present at such office upon whom such notices may be served and service of any notices left with such clerk or other authorized person or at such office shall be deemed good service upon the Contractor and such offices shall have pre-requisite facilities for e- governance.

69. Official Secrecy:

The Contractor shall of all the persons employed in any works in connection with the contract that the India Official Secrets Act 1923 (XIX of 1923) applies to them and will continue to apply even after execution of the said works and they will not disclose any information regarding this contract to any third party. The contractor shall also bring into notice that, any information found to be leaked out or disclosed the concern person as well as the Contractor will be liable for penal action; further the Corporation will be at liberty to terminate the contract without notice.

70. Subsequent Legislation:

If on the day of submission of bids for the contract, there occur changes to any National or State statute, Ordinance, decree or other law or any regulation or By-laws or any local or other duly constituted authority or the introduction of any such National or State Statute, Ordinance, decree or by which causes additional or reduced cost to the Contractor, such additional or reduced cost shall, after due consultation with the Contractor, be determined by the concerned Engineering Department of BMC and shall be added to or deducted from the Contract Price with prior approval of

competent authority and the concerned Engineering Department shall notify the Contractor accordingly with a copy to the Employer. BMC reserve the right to take decision in respect of addition/reduction of cost in contract.

71. Patent, Right and Royalties:

The contractor shall save harmless and indemnify the Corporation from and against all claims and proceedings for or on account of infringement of any Patent rights, design trademark or name of other protected rights in respect of any constructional plant, machine work, or material used for or in connection with the Works or any of them and from and against all claims, proceedings, damages, costs, charges and expenses whatsoever in respect thereof or in relation thereto. Except where otherwise specified, the contractor shall pay all tonnage and other royalties, rent and other payments or compensation, if any, for getting stone, sand, gravel, clay or other materials required for the works or any of them.

72. Payments, Tax and Claims:

- **The limit for unforeseen claims**

Under no circumstances whatever the contractor shall be entitled to any compensation from BMC on any account unless the contractor shall have submitted a claim in writing to the Eng-in-charge within 1 month of the case of such claim occurring.

- **No interest for delayed payments due to disputes, etc:**

It is agreed that the Brihanmumbai Municipal Corporation (BMC) or its Engineer or Officer shall not be liable to pay any interest or damage with respect of any moneys or balance which may be in its or its Engineer's or officer's hands owing to any dispute or difference or claim or misunderstanding between the Brihanmumbai Municipal Corporation (BMC) or its Engineer or Officer on the one hand and the contractor on the other, or with respect to any delay on the part of the Brihanmumbai Municipal Corporation (BMC) or its Engineer or Officers in making periodical or final payments or in any other respect whatever.

73. Settlement of Disputes:

- **Termination of contract for death**

If the Contractor is an individual or a proprietary concern and the individual or the proprietor dies and if the Contractor is a partnership concern and one of the legal representative of the individual Contractor or the proprietor of the proprietary concern and in case of partnership, the surviving partners, are capable of carrying out and completing the contract, the Commissioner shall be entitled to cancel the contract as to its uncompleted part without the Corporation being in any way liable to payment of any compensation to the estate of the deceased Contractor and or to the surviving partners of the Contractor's firm on account of the cancellation of the contract. The decision of the Commissioner that the legal representative of the

deceased Contractor or surviving partners of the Contractor's firm cannot carry out and complete the contract shall be final and binding on the parties. In the event of such cancellation the Commissioner shall not hold estate of the deceased Contractor and or surviving partners of the Contractor's firm liable in damages for not completing the contract.

- **Settlement of Disputes:**

If any dispute or differences of any kind whatsoever other than those in respect of which, the decision of any person is, by the Contract, expressed to be final and binding) shall arise between the Employer and the Contractor or the Engineer and the Contractor in connection with or arising out of the Contract or carrying out of the Works (Whether during the progress of the Works or after their completion and whether before or after the termination, abandonment or breach of the Contract) it, the aggrieved party may refer such dispute within a period of 7 days to the concerned Addl. Municipal Commissioner who shall constitute a committee comprising of three officers i.e. concerned Deputy Municipal Commissioner or Director (ES&P), Chief Engineer other than the Engineer of the Contract and concerned Chief Accountant. The Committee shall give decision in writing within 60 days. Appeal on the Order of the Committee may be referred to the Municipal Commissioner within 7 days. Thereafter the Municipal Commissioner shall constitute a Committee comprising of three Addl. Municipal Commissioners including Addl. Municipal Commissioner in charge of Finance Department. The Municipal Commissioner within a period of 90 days after being requested to do so shall give written notice of committee's decision to the Contractor. Save as herein provided such decision in respect of every matter so referred shall be final and binding upon both parties until the completion of the works, and shall forthwith be given effect to by the Contractor who shall proceed with the works with due diligence, whether he requires arbitration as hereinafter provided or not. If the Commissioner has given written notice of the decision to the Contractor and no Claim to arbitration has been communicated within a period of 90 days from receipt of such notice the said decision shall remain final and binding upon the Contractor.

74. Arbitration and Jurisdiction:

If the Commissioner fail to give notice of the decision as aforesaid within a period of 90 days after being requested as aforesaid, or if the Contractor is dissatisfied with any such decision, then the Contractor may within 90 days after receiving notice of such decision or within 90 days after the expirations of the first named period of 90 days (as the case may be) require that the matter or matters in dispute be referred to arbitration as hereinafter provided.

- 1) In case of a contract where the contract price and/ or contract value is less than Rs. 5,00,00,000/- (Rupees five crore only), any dispute arising out of or in connection with this contract, including any question regarding its existence,

validity or termination, shall be referred to a mutually agreed arbitral tribunal in accordance with the Arbitration and conciliation Act, 1996 (amended upto date). The arbitral tribunal shall consist of a sole arbitrator, as mutually agreed upon by the parties and the said dispute shall be finally resolved by the said arbitral tribunal. The decision of the arbitral tribunal shall be in writing (with reason) and which will be final and binding upon the parties hereto and the expenses of the arbitration shall ne paid as may be determined by the arbitrail tribunal. The seat of the arbitration shall be Mumbai. The venue of arbitration shall be within the limits of BrihanMumbai. The language of the Arbitration shall ne English.

If the parties fails to appoint mutually agreed arbitral tribunal, within the period of 30 days from the date of application seeking arbitration seeking arbitration in the dispute, the arbitral tribunal shall be appointed by the recognized arbitral institution i.e. Mumbai Centre for International Arbitration (Approved by Government of Maharashtra under G.R. No. ARB/Case no. 1/2017/D-19 dated 28.02.2017) as per the Arbitration Rules of the Mumbai of the Centre for International Arbitration then in force (“MCIA Rules”)

ii) In case of contract where the contract price and or contract value is Rs.5,00,00,000/- (Rupees Five Crore Only) or more, any dispute arising out of or in connection with such a contract, including any question regarding its existence, validity or termination, shall be directly referred to and finally resolved by the recognized arbitral institution i.e. Mumbai Centre for International Arbitration (approved by Government of Maharashtra under G.R. no. ARB/Case No.1,/2017/D-19 dtd. 28.02.2017) as per the Arbitration Rules of the Mumbai Centre for International Arbitration then in force (“MCIA Rules”).The arbitral tribunal shall consist of a sole arbitrator. The seat of the arbitration shall be Mumbai. The language of the Arbitration shall be English.

In either case, the law governing this arbitration agreement and the contract shall be Indian Law.

75. Copyright:

The copyright of all drawings and other documents provided by the Contractor under the contract shall remain vested in the Contractor or his sub-contractors as the case may be the employer shall have a license to use such drawings and other documents in connection with the design, construction, operation, maintenance of the works. At any time the Employer shall have further license without additional payment to the Contractor to use any such drawings or documents for the purpose of making any improvement of the works or enlargement or duplication of any part thereof, provided that such improvement, enlargement, or duplication by itself or in conjunction with any other improvements, enlargements or duplications already made in accordance with the further license does not result in the duplication of the whole works.

76. Receipts to be signed in firm's name by any one of the partners:

Every receipt for money which may become payable or for any security which may become transferable to the Contractor under these present shall, if signed in the partnership name by any one of the partners, be a good and sufficient discharge to the Commissioner and Municipal Corporation in respect of the money or security purporting to be acknowledged thereby, and in the event of death of any of the partners during the pendency of this contract, it is hereby expressly agreed that every receipt by any one of the surviving partners shall, if so signed as aforesaid, be good and sufficient discharge as aforesaid provided that nothing in this clause contained shall be deemed to prejudice or effect any claim which the Commissioner or the Corporation may hereafter have against the legal representatives of any partners so dying or in respect of any breach of any of the conditions thereof, provided also that nothing in this clause contained shall be deemed prejudicial or affect the respective rights or obligations of the Contractors and of the legal representatives of any deceased Contractors interest.

77. Proprietary data

All documents and other information supplied by the Authority or submitted by an Applicant to the Authority shall remain or become the property of the Authority. Applicants are to treat all information as strictly confidential and shall not use it for any purpose other than for preparation and submission of their Application. The Authority will not return any Application or any information provided along therewith.

78. Correspondence with the Applicant

Save and except as provided in this TENDER, the Authority shall not entertain any correspondence with any Applicant in relation to the acceptance or rejection of any Application.

79. Price Variation Clause

The Contractor shall be reimbursed or shall refund to the Corporation as he case may be the variation in the value of the work carried out from time to time, depending on whether the prices of material and labour as a whole rise or fall, and the method adopted for such computations shall be as given below, it being clearly understood that the contractor shall have no claim for being reimbursed on the ground that the price of a particular material or group of materials have risen beyond the limits of the presumptions made in the following paras, however, no price variations shall be made applicable for contracts upto 12 months:

(A) Controlled materials: Price variations shall be permitted in respect of these materials the price level of which is controlled by the Government or its agency.

The rate ruling on the date of submission of the tender shall be considered as the basic price of such material for adjustment. Any variation in this rate shall be considered for reimbursement to the contractor or refund to be claimed from the contractor as the case may be. The contractor shall, for the purpose of adjustment submit in original the relevant documents from the suppliers.

(B) Labour and other materials: For the purpose of this contract and for allowing reimbursement of refund on account of variation of prices of (i) labour, and (ii) materials other than materials mentioned in A above, computation will be based on the formula enunciated below which is based on the presumptions that:

- i) The general price level of labour, rises or falls in proportion to the rise or fall of consumer price index number 9 (general) for working class in Mumbai.
- ii) The general price level of materials rises or falls in proportion to rise or fall of whole-sale price index as published by 'Economic Adviser to Govt. of India'.
- iii) And that the component of labour is to the extent of 30 percent of 88 percent and the component of materials is to the extent of 70 percent of 88 percent of the value of the work carried out. The remaining 12 percent being the presumptive profit of the contractor.

a) Formula for Labour component:

$$VL = \frac{(0.88 R) \times 30}{100} \times \frac{(I - IO)}{IO}$$

b) Formula for Material component:

$$VM = \frac{(0.88 R \times 70 - C) \times (W - WO)}{100 - WO}$$

Where –

VL = Amount of price variation to be reimbursed or claimed as refund on account of general rise or fall of index referred to above.

I = Consumer Price Index number of working class for Mumbai (declared by the Commissioner of Labour and Director of Employment, Mumbai) applicable to the period under reference (base year ending 2004-05 as 100 i.e. new series of indices).

IO = Consumer price index number for working class for Mumbai (declared by the

Commissioner of labour and Director of Employment, Mumbai) prevailing, on the day of 28 days prior to the date of submission of the tender.

VM = The amount of price variation to be reimbursed or claimed as refund on account of general rise or fall of wholesale price index for period under reference.

W = Average wholesale price index as published by Economic Adviser to Govt. of India applicable to the period under reference.

WO = Wholesale price index as stated above prevailing on the day of 28 days prior to the date of submission of the tender.

R = Total value of the work done during the period under reference as recorded in the Measurement Book excluding water charges and sewerage charges but including cost of excess in respect of item upto 50 percent

C = Total value of Controlled materials used for the works as recorded in Measurement Book and paid for at original basic rate plus the value of materials used .

- i) The quantity of the Controlled material adopted in working out the value of 'C' shall be inclusive of permitted wastages as / if mentioned in specifications.
- ii) The basic rate for the supply of controlled material shall be inclusive of all the components of cost of materials excluding transport charges incurred for bringing the material from place of delivery to the site.

Computations based on the above formula will be made for the period of each bill separately and reimbursement will be made to (when the result is plus) and refund will claimed from (when the result is minus) the contractor's next bill. The above formulae will be replaced by the formulae in Annexure-I as and when mentioned in special conditions of contract

The operative period of the contract for application of price variation shall mean the period commencing from the date of commencement of work mentioned in the work order and ending on the date when time allowed for the work order and ending on the date when time allowed for the work specified in the contract for work expires, taking into consideration, the extension of time, if any, for completion of the work granted by Engineer under the relevant clause of the conditions of contract in cases other than those where such extension is necessitated on account of default of the contractor.

The decision of the Engineer as regards the operative period of the contract shall be final and binding on the contractors.

- iii) Where there is no supply of controlled items to contractor the component 'C' shall be taken as zero.

(C) Adjustment after completion: If the Contractor fails to complete the works within the time for completion adjustment of prices thereafter until the date of completion of the works shall be made using either the indices or prices

relating to the prescribed time for completion, or the current indices or prices whichever is more favorable to the employer, provided that if an extension of time is granted, the above provision shall apply only to adjustments made after the expiry of such extension of time.

- (D) Price variation will be calculated similarly and separately for extra items and / or excess quantities and provisional sums calculated under Sub Clause 10 (b)A (i)&(ii) and Sub Clause 10 (b) B(ii) based on the above formula/formulae in Annexure-I as and when mentioned in Special conditions of contract; IO and WO being the indices applicable to the date on which the rates under Sub Clause 10 (a)A (i)&(ii) and Sub Clause 10 (a) B(iii) are fixed. No price variation shall be admissible for FAIR items created during execution.

80. Maximum Price Variation shall be as follows:

Time period of Project	Maximum limit of Price Variation
Upto 12 Months	No Variation allowed
Above 12 Months to 24 Months	5%
Above 24 Months	10%

- **Approval of AMC/MC shall be obtained before invitation of tender in case of any changes in above.**

Note:

- 1) **The extension in time period for the projects originally estimated including monsoon results in change of price variation slabs as mentioned above i.e.from first slab to second slab or from second slab to third slab, then the maximum limit of original slab will prevail.**
- 2) Operative period shall mean original or extended time period of contract.

For example:

Extension of Time period	Maximum limit of Price Variation
If original period of 11 Months including monsoon extends to 16. The operative period will be 11+5 Months	No Variation allowed
If original period of 11 Months excluding monsoon extends to 16. The operative period will be 11+5 Months	5%

Price Variation during Extended Period of Contract:

- i. **Extension Due To Modification & Extension for delay due to BMC:**

The price variation for the period of extension granted shall be limited to the amount payable as per the Indices. In case the indices increases or decreases,

above/below the indices applicable, to the last month of the original or extended period vide clause 8(l)(a)(i) and (ii) of standard GCC

ii. Extension Of Time For Delay Due To Contractor :

- a) The price variation for the period of extension granted shall be limited to the amount payable as per the Indices in case the indices increase, above the indices applicable, to the last month of the original completion period or the extended period vide above clause 8(l)(a)(i) and (ii) of standard GCC.
- b) The price variation shall be limited to the amount payable as per the indices, in case the indices decrease or fall below the indices applicable, to the last month of original / extended period of completion period vide above clause 8(l)(b) of standard GCC, then lower indices shall be adopted.

iii. Extension of Time For Delay due to reasons not attributable to BMC and Contractor (Reference Cl.8(d) of Standard GCC):

The price variation for the period of extension granted shall be limited to the amount payable as per the Indices in case the indices increases or decreases, above/below the indices applicable, to the last month of the original period.

81. Payment:

Interim Payment :

- (i) Regarding Contract / security deposits / Retention money, contractor will be bound to abide the conditions as mentioned in the circular issued by CA (F) (Projects) u/no. CA / F/ Projects / 21 dt. 07.09.2020.
- (ii) Interim bills shall be submitted by the Contractor from time to time (but at an interval of not less than one month) for the works executed. The Engineer shall arrange to have the bills verified by taking or causing to be taken, where necessary, the requisite measurement of work.
- (iii) Payment on account for amount admissible shall be made on the Engineer certifying the sum to which the Contractor is considered entitled by way of interim payment for all the work executed, after deducting there from the amount already paid, the security deposit / retention money and such other amounts as may be deductible or recoverable in terms of the contract.
- (iv) On request, the contractor will be paid upto 75 percent of the value of the work carried out as an adhoc payment in the first week of next month after deducting there from recoveries on account of advances, interest, retention money, income tax etc. The balance payment due will be paid thereafter.
- (v) No interim payment will be admitted until such time the Contractor have fully complied with the requirement of the Condition no.8 (g) and 8 (h) concerning submission and approval of Network Schedule for the works, as detailed in

Condition 8 (h). A fixed sum shall be held in abeyance at the time of next interim payment for non-attainment of each milestone in the network and shall be released only on attainment of the said milestone.

- (vi) An interim certificate given relating to work done or material delivered may be modified or corrected by a subsequent interim certificate or by the final certificate. No certificate of the Engineer supporting an interim payment shall of itself be conclusive evidence that any work or materials to which it relates is / are in accordance with the contract.

82. Banning/De-Registration of Agencies of Construction works in BMC

- **The regulations regarding Demotion/ Suspension Banning for specific period or permanently / De-Registration shall be governed as per the respective condition in Contractor Registration Rules of BMC.**

83. JOINT VENTURE

In case if Joint Venture is allowed for the Project, the guidelines for JV as follows shall be incorporated in the Tender Document:

- a) Joint Venture should be allowed only when the number of identifiable different works is more than one and/or the estimated cost of tender is more than Rs.100 Crores. JV shall also be allowed for complex technical work below Rs.100 Crores with the approval of concerned AMC
- b) Separate identity/name shall be given to the Joint Venture firm.
- c) Number of members in a JV firm shall not be more than three in normal circumstances, if the work involves only one discipline (say Civil or Electrical). If number of members in JV is required to be more than three, then approval of concerned AMC needs to be sought.
- d) A member of JV firm shall not be permitted to participate either in individual capacity or as a member of another JV firm in the same tender.
- e) The tender form shall be purchased and submitted in the 'name of the JV firm or any constituent member of the JV.
- f) Normally EMD shall be submitted only in the name of the JV and not in the name of constituent member. However, EMD in the name of lead partner can be accepted subject to submission of specific request letter from lead partner stating the reasons for not submitting the EMD in the name of JV and giving written confirmation from the JV partners to the effect that the EMD submitted by the lead partner may be deemed as EMD submitted by JV firm.
- g) One of the members of the JV firm shall be the lead member of the JV firm who shall have a majority (at least 51%) share of interest in the JV firm. The other

members shall have a share of not less than 20% each in case of JV firms with up to three members and not less than 10% each in case of JV firms with more than three members. In case of JV firm with foreign member(s), the lead member has to be an Indian firm with a minimum share of 51%.

- h)** A copy of Letter of Intent or Memorandum of Understanding (MoU) executed by the JV members shall be submitted by the JV firm along with the tender. The complete details of the members of the JV firm, their share and responsibility in the JV firm etc. particularly with reference to financial technical and other obligation shall be furnished in the agreement.
- i)** Once the tender is submitted, the agreement shall not be modified/alterd/terminated during the validity of the tender. In case the tenderer fails to observe/comply with this stipulation, the full Earnest Money Deposit (EMD) shall be forfeited. In case of successful tenderer, the validity of this agreement shall be extended till the currency of the contract expires.
- j)** Approval for change of constitution of JV firm shall be at the sole discretion of the BMC. The constitution of the JV firm shall not be allowed to be modified after submission of the tender bid by the JV firm except when modification becomes inevitable due to succession laws etc. and in any case the minimum eligibility criteria should not get vitiated. In any case the Lead Member should continue to be the Lead Member of the JV firm. Failure to observe this requirement would render the offer invalid.
- k)** Similarly, after the contract is awarded, the constitution of JV firm shall not be allowed to be altered during the currency of contract except when modification become inevitable due to succession laws etc. and in any case the minimum eligibility criteria should not get vitiated. Failure to observe this stipulation shall be deemed to be breach of contract with all consequential penal action as per contract condition.
- l)** On award of contract to a JV firm, a single Performance Guarantee shall be required to be submitted by the JV firm as per tender conditions. All the Guarantees like Performance Guarantee, Bank Guarantee for Mobilization advance, machinery Advance etc. shall be accepted only in the name of the JV firm and no splitting of guarantees amongst the members of the JV firm shall be permitted.
- m)** On issue of LOA, an agreement among the members of the JV firm (to whom the work has been awarded) has to be executed and got registered before the Registrar of the Companies under Companies Act or before the Registrar / Sub-Registrar under the Registration Act, 1908. This agreement shall be submitted by the JV firm to the BMC before signing the contract agreement for the work. (This agreement format should invariably be part of the tender condition). In

case the tenderer fails to observe/comply with this stipulation, the full Earnest Money Deposit (EMD) shall be forfeited and other penal actions due shall be taken against partners of the JV and the JV. This joint venture agreement shall have, inter-alia, following clauses:-

- (i) **Joint and several liability** - The members of the JV firm to which the contract is award- ed, shall be jointly and severally liable to the Employer (BMC) for execution of the pro- ject in accordance with General and Special conditions of the contract. The JV members shall also be liable jointly and severally for the loss, damages caused to the BMCduring the course of execution of the contract or due to no execution of the contract or part there- of.
- (ii) **Duration of the Joint Venture Agreement** -It shall be valid during the entire period of the contract including the period of extension if any and the maintenance period after the work is completed.
- (iii)**Governing Laws** - The Joint Venture Agreement shall in all respect be governed by and interpreted in accordance with Indian Laws.
- (iv) **Authorized Member** -Joint Venture members shall authorize one of the members on be- half of the Joint Venture firm to deal with the tender, sign the agreement or enter into con- tract in respect of the said tender, to receive payment, to witness joint measurement of work done, to sign measurement books and similar such action in respect of the said tender/contract. All notices/correspondences with respect to the contract would be sent only to this authorized member of the JV firm.
- (v) No member of the Joint Venture firm shall have the right to assign or transfer the interest right or liability in the contract without the written consent of the other members and that of the employer in respect of the said tender/contract.

n) Documents to be enclosed by the JV firm along with the tender:

- i. In case one or more of the members of the JV firm is/are partnership firm(s), following documents shall be submitted:
 - a. Notary certified copy of the Partnership Deed,
 - b. Consent of all the partners to enter into the Joint Venture Agreement on a stamp paper of appropriate value (in original).
 - c. Power of Attorney (duly registered as per prevailing law) in favor of one of the partners to sign the MOU and JV Agreement on behalf of the partners and create liability against the firm.

- ii. In case one or more members is/are Proprietary Firm or HUF, the following documents shall be enclosed:
 - a. Affidavit on Stamp Paper of appropriate value declaring that his Concern is a Proprietary Concern and he is sole proprietor of the Concern OR he is in position of "KARTA" of Hindu Undivided Family and he has the authority, power and consent given by other partners to act on behalf of HUF.
- iii. In case one or more members is/are limited companies, the following documents shall be submitted:
 - a. Notary certified copy of resolutions of the Directors of the Company, permitting the company to enter into a JV agreement, authorizing MD or one of the Directors or Managers of the Company to sign MOU, JV Agreement, such other documents required to be signed on behalf of the Company and enter into liability against the company and/or do any other act on behalf of the company.
 - b. Copy of Memorandum and articles of Association of the Company.
 - c. Power of Attorney (duly registered as per prevailing law) by the Company authorizing the person to do/act mentioned in the para (a) above.
- o) All the members of the JV shall certify that they have not been black listed or debarred by BMC from participation in tenders/contract in the past either in their individual capacity or the JV firm or partnership firm in which they were members / partners.
- p) Credentials & Qualifying criteria: Technical and financial eligibility of the JV firm shall be adjudged based on satisfactory fulfillment of the following criteria:

Technical eligibility criteria: In case of Work involving single discipline, the Lead member of the JV firm shall meet at least 35% requirement of technical capacity as stipulated in tender document.

OR

In case of composite works (e.g. works involving more than one distinct component such as Civil Engineering works, M&E works, Electrical works, etc. and in the case of major bridges, substructure and superstructure etc.), atleast one member should have satisfactorily completed 35% of the value of any one component of the project work so as to cover all the components of project work or any member having satisfactorily completed 35% of the value of work of each component during last seven financial years.

In such cases, what constitutes a component in a composite work shall be clearly defined as part of the tender condition without any ambiguity.

Financial eligibility criteria: “ The **average annual** contractual payments received by the JV firm or the arithmetic sum of **average annual** contractual payments received by all the members of JV firm, in proportion to their share in JV, **in last three financial years** shall be **at least 30% of the estimated value** of the work as mentioned in the tender.”

Compensation for delay:

If the Contractor fails to complete the works and clear the site on or before the Contract or extended date(s) / period(s) of completion, he shall, without prejudice to any other right or remedy of Municipal Corporation on account of such breach, pay as agreed compensation, amount calculated as stipulated below (or such smaller amount as may be fixed by the Engineer) on the contract value of the whole work or on the contract value of the time or group of items of work for which separate period of completion are given in the contract and of which completion is delayed for every week that the whole of the work of item or group of items of work concerned remains uncompleted, even though the contract as a whole be completed by the contract or the extended date of completion. For this purpose the term ‘Contract Value’ shall be the value of the work at Contract Rates as ordered including the value of all deviations ordered:

- Completion period for projects (originally stipulated or as extended) not exceeding 6 months: **to the extent of maximum 1 percent per week.**
- Completion period for projects (originally stipulated or as extended) exceeding 6 months and not exceeding 2 years: **to the extent of maximum ½ percent per week.**
- Completion period for projects (originally stipulated or as extended) exceeding 2 years : **to the extent of maximum ¼ percent per week.**

When the delay is not a full week or in multiple of a week but involves a fraction of a week the compensation payable for that fraction shall be proportional to the number of days involved.

Provided always that the total amount of compensation for delay to be paid this condition shall not exceed the undernoted percentage of the Contract Value of the item or group of items of work for which a separate period of completion is given.

- (i) Completion period (as originally stipulated or as extended) not exceeding 6 months: **10 percent.**
- (ii) Completion period (as originally stipulated or as extended) exceeding 6 months and not exceeding 2 years : **7½ percent.**

- (iii) Completion period (as originally stipulated or as extended) exceeding 2 years : **5 percent.**

The amount of compensation may be adjusted set off against any sum payable to the contractor under this or any other contract with the Municipal Corporation.

84. Action And Compensation Payable In Case Of Bad Work And Not Done As Per Specifications

All works under or in course of execution or executed in pursuance of the contract, shall at all times be open and accessible to the inspection and supervision of the Engineer-in-charge, his authorized subordinates in charge of the work and all the superior officers, officer of the Vigilance Department of the BMC or any organization engaged by the BMC for Quality Assurance and the contractor shall, at all times, during the usual working hours and at all other times at which reasonable notice of the visit of such officers has been given to the contractor, either himself be present to receive orders and instructions or have a responsible agent duly accredited in writing, present for that purpose. Orders given to the Contractor's agent shall be considered to have the same force as if they had been given to the contractor himself.

If it shall appear to the Engineer-in-charge or his authorized subordinates in-charge of the work or to the officer of Vigilance Department, that any work has been executed with unsound, imperfect or unskillful workmanship or with materials of any inferior description, or that any materials or articles provided by him for the execution of the work are unsound or of a quality inferior to that contracted for or otherwise not in accordance with the contract, the contractor shall, on demand in writing which shall be made within twelve months of the completion of the work from the Engineer-in-Charge specifying the work, materials or articles complained of notwithstanding that the same may have been passed, certified and paid for forthwith rectify, or remove and reconstruct the work so specified in whole or in part, as the case may require or as the case may be, remove the materials or articles so specified and provide other proper and suitable materials or articles at his own charge and cost. In the event of the failing to do so within a period specified by the Engineer-in-Charge in his demand aforesaid, then the contractor shall be liable to pay compensation at the same rate as under clause 8.e. of the general condition of contract in section 9 of tender document (for Compensation for delay) for this default. In such case the Engineer-in Charge may not accept the item of work at the rates applicable under the contract but may accept such items at reduced rates as the Engineer in charge may consider reasonable during the preparation of on account bills or final bill if the item is so acceptable without detriment to the safety and utility of the item and the structure or he may reject the work outright without any payment and/or get it and other connected and incidental items rectified, or removed and re-executed at the risk and cost of the contractor. Decision of the Engineer-in- Charge to be conveyed in writing in respect of

the same will be final and binding on the contractor.

If the penalization amount exceeds maximum limit with respect to Clause 8.e of Standard General Conditions of Contract, then a show cause notice shall necessarily be issued to the contract as to why the contract should not be terminated.

85. Contractors remain liable to pay compensation:

In any case in which any of the powers conferred upon the Engineer In-charge by the **relevant clauses** in documents that form a part of contract as exercised or is exercisable in the event of any future case of default by the Contractor, he is declared liable to pay compensation amounting to the whole of his security deposit. The liability of the Contractor for past and future compensation shall remain unaffected.

In the event of the Executive Engineer taking action against these **relevant clauses**, he may, if he so desires, take possession of all or any tools and plant, materials and stores in or upon the work of site thereof or belonging to the Contractor or procured by him and intended to be used for the execution of the work or any part thereof paying or allowing for the same in account at the contract rates, or in the case of contract rates not being applicable at current market rates to be certified by the Executive Engineer, may after giving notice in writing to the Contractor or his staff of the work or other authorized agent require him to remove such tools and plants, materials or stores from the premises within a time to be specified in such notice and in the event of the Contractor failing to comply with any such requisition, the Executive Engineer may remove them at the contractors expense or sell them by auction or private sell on account of the Contractor at his risk in all respects and certificate of the Executive Engineer as to the expense of any such removal and the amount of the proceeds an expense of any such sell be final and conclusive against the Contractor.

86. No Claim To Any Payment Or Compensation Or Alteration In Or Restriction Of Work

- a) If at any time after the execution of contract documents, the Engineer shall for any reason whatsoever, desires that the whole or any part of the works specified in the Tender should be suspended for any period or that the whole or part of the work should not be carried out, at all, he shall give to the Contractor a Notice in writing of such desire and upon the receipt of such notice, the Contractor shall forthwith suspend or stop the work wholly or in part as required after having due regard to the appropriate stage at which the work should be stopped or suspended so as not to cause any damage or injury the work already done or endanger the safety thereof, provided that the decision of the Engineer as to the stage at which the work or any part of it could be or could have been safely stopped or suspended shall be final and conclusive against the contractor.

The Contractor shall have no claim to any payment or compensation

whatsoever by reason of or in pursuance of any notice as aforesaid, on account of any suspension, stoppage or curtailment except to the extent specified hereinafter.

b) Where the total suspension of Work Order as aforesaid continued for a continuous period exceeding 90 days the contractor shall be at liberty to withdraw from the contractual obligations under the contract so far as it pertains to the unexecuted part of the work by giving 10 days prior notice in writing to the Engineer within 30 days of the expiry of the said period of 90 days, of such intention and requiring the Engineer ing to record the final measurement of the work already done and to pay final bill. Upon giving such Notice, the Contractor shall be deem to have been discharged from his obligations to complete the remaining unexecuted work under his contract. On receipt of such notice the Engineer shall proceed to complete the measurement and make such payment as may be finally due to the contractor within a period of 90 days from the receipt of such Notice in respect of the work already done by the contractor. Such payment shall not in any manner prejudice the right of the contractor to any further compensation under the remaining provisions of this clause.

c) Where the Engineer required to Contractor to suspend the work for a period in excess of 30 days at any time or 60 days in the aggregate, the Contractor shall be entitled to apply to the Engineer within 30 days of the resumption of the work after such suspension for payment of compensation to the extent of pecuniary loss suffered by him in respect of working machinery remained ideal on the site of on the account of his having an to pay the salary of wages and labour engaged by him during the said period of suspension provided always that the contractor shall not be entitled to any claim in respect of any such working machinery, salary or wages for the first 30 days whether consecutive or in the aggregate or such suspension or in respect of any such suspension whatsoever occasion by unsatisfactory work or any other default on his part, the decision of the Engineer in this regard shall be final and conclusive against the contractor.

87. Contractor to supply plant, ladder, scaffolding, etc and is liable for damages arising from non provision of lights, fencing, etc.

The Contractor shall supply at his own cost all material, plant, tools, appliances, implements, ladders, cordage, tackle scaffolding and temporary works requisite or proper for the proper execution of the work, whether, in the original altered or substituted form and whether included in the specification of other documents forming part of the contract or referred to in these conditions or not and which may be necessary for the purpose of satisfying or complying with the requirements of the Eng-In-Charge as to any matter as to which under these conditions is entitled to be satisfied, or which is entitled to require together with the carriage therefore to and from the work.

The Contractor shall also supply without charge, the requisite number of person with the means and materials necessary for the purpose of setting out works and counting, weighing and assisting in the measurements of examination at any time and from time to time of the work or materials, failing which the same may be provided by the Engineer In-charge at the expense of the contractor and the expenses may be deducted from any money due to the contractor under the contract or from his security deposit or the proceeds of sale thereof, or offers sufficient portion thereof.

The contractor shall provide all necessary fencing and lights required to protect the public from accident and shall also be bound to bear the expenses of defence of every suit, action or other legal proceedings, that may be brought by any person for injury sustained owing to neglect of the above precautions and to pay any damages and cost which may be awarded in any such suit action or proceedings to any such person or which may with the consent of the contractor be paid for compromising any claim by any such person.

88. Prevention of Fire :

The contractor shall not set fire to any standing jungle, trees, brushwood or grass without a written permit from the Engineer In-charge. When such permit is given, and also in all cases when destroying cut or dug up trees brushwood, grass, etc., by fire, the contractor shall take necessary measure to prevent such fire spreading to or otherwise damaging surrounding property. The Contractor shall make his own arrangements for drinking water for the labour employed by him.

89. Compensation for all damages done intentionally or unintentionally by contractor's labour whether in or beyond the limits of BMC property including any damage caused by spreading the fire shall be estimated by the Engineer In-charge or such other officer as he may appoint and the estimate of the Engineer in-charge to the decision of the Dy. Chief Engineer on appeal shall be final and the contractor shall be bound to pay the amount of the assessed compensation on demand failing which the same will be recovered from the Contractor as damages or deducted by the Engineer In-charge from any sums that may be due or become due from BMC to contractor under this Contract or otherwise. Contractor shall bear the expenses of defending any action or other legal proceedings that may be brought to prevent the spread of fire and he shall pay any damages and costs that may be awarded by the Court in consequence.

90. In the case of Tender by partners, any change in the constitution of the firm shall be forthwith, notified by the contractor through the Engineer In-charge for his information.

91. Action where no specifications :

In the case of any class of work for which there is no such specifications, such works shall be carried out in accordance with the specifications and in the event of there being no such specifications, then in such case, the work shall be carried out in all respects in accordance with all instructions and requirements of the Engineer In-

charge.

92. Safety and medical help :

- (i) The Contractor shall be responsible for and shall pay the expenses of providing medical help to any workmen who may suffer a bodily injury as a result of an accident. If such expenses are incurred by BMC, the same shall be recoverable from the contractor forthwith and be included without prejudice to any other remedy of BMC from any amount due or that may become due to the Contractor.
- (ii) The contractor shall provide necessary personal safety equipment and first-aid box for the use of persons employed on the site and shall maintain the same in condition suitable for immediate use at any time.
- (iii) The workers shall be required to use the safety equipments so provided by the contractor and the contractor shall take adequate steps to ensure the proper use of equipments by those concerned.
- (iv) When the work is carried on in proximity to any place where there is risk or drawing all necessary equipments shall be provided and kept ready for use and all necessary steps shall be taken for the prompt rescue of any person in danger.

93. No compensation shall be allowed for any delay caused in the starting of the work on account of acquisition of land or in the case of clearance of works, on account of any delay in according to sanction of estimates.

94. Anti-malaria and other health measures:

Anti-Malaria and other health measures shall be taken as directed by the Executive Health Officer of BMC. Contractor shall see that mosquito genic conditions are created so as to keep vector population to minimum level. Contractor shall carry out anti-malaria measures in the area as per the guidelines issued by the Executive Health Officer of BMC from time to time.

In case of default, in carrying out prescribed anti-malaria measures resulting in increase in malaria incidence, contractor shall be liable to pay BMC on anti-malaria measures to control the situation in addition to fine.

95. INTERVAL GRIEVANCE REDRESSAL MECHANISM

M.C.G.M. has formed an Internal Grievance Redressal Mechanism for redressal of bidder's grievances. Any Bidder or prospective Bidder aggrieved by any decision, action or omission of the procuring entity being contrary to the provisions of the tender or any rules or guidelines issued therein, in Packet 'A', 'B' & 'C' can make an application for review of decision of responsiveness in Packet 'A', 'B' & 'C' within a period of 7 days or any such other period, as may be specified in the Bid document.

While making such an application to procuring entity for review, aggrieved bidders or prospective bidders shall clearly specify the ground or grounds in respect of which he feels aggrieved.

Provided that after declaration of a bidder as a successful in Packet 'A' (General Requirements), an application for review may be filed only by a bidder who has participated in procurement proceedings and after declaration of successful bidder in Packet 'B' (Technical Bid), an application for review may be filed only by successful bidders of Packet 'A'. Provided further that, an application for review of the financial bid can be submitted, by the bidder whose technical bid is found to be acceptable / responsive.

Upon receipt of such application for review, B.M.C. may decide whether the bid process is required to be suspended pending disposal of such review. The B.M.C. after examining the application and the documents available to him, give such reliefs, as may be considered appropriate and communicate its decision to the Applicant and it required to other bidders or prospective bidders, as the case may be.

B.M.C. shall deal and dispose off such application as expeditiously as possible and in any case within 10 days from the date of receipt of such application or such other period as may be specified in pre-qualification document, bidder registration document or bid documents, as the case may be.

Where B.M.C. fails to dispose off the application within the specified period or if the bidder or prospective bidder feels aggrieved by the decision of the procuring entity, such bidder or prospective bidder may file an application for redressal before the 'Internal Procurement Redressal Committee' within 7 days of the expiry of the allowed time or of the date of receipt of the decision, as the case may be. Every such application for internal redressal before Redressal Committee shall be accompanied by fee of Rs.25,000/- and fee shall be paid in the form of D.D. in favour of B.M.C.

1st Appeal by the bidder against the decision of C.E./HoD/Dean can be made to concerned D.M.C /Director who should decide appeal in 7 days.

If not satisfied, 2nd Appeal by the bidder can be made to concerned A.M.C for decision.

Grievance Redressal Committee (GRC) is headed by concerned D.M.C / Director of particular department for the first appeal / grievances by the bidder against the decision for responsiveness / non-responsiveness in Packet 'A',

Packet 'B' or Packet 'C', and If not satisfied, concerned A.M.C. will take decision as per second appeal made by the bidder,

This Grievance Redressal Committee (GRC) will be operated through DMC(CPD) office where appeals of aggrieved bidder will be received with fee of Rs. 25,000/- from aggrieved bidder. The necessary correspondence in respect of said applications to the aggrieved bidder & concerned department, issuing notices, arranging of Grievance Redressal Committee (GRC) with D.M.C and further proceeding will be carried out through registrar appointed by BMC.

No application shall be maintainable before the redressal Committee in regard of any decision of the B.M.C. relating to following issues:

Determination of need of procurement

The decision of whether or not to enter into negotiations.

Cancellation of a procurement process for certain reasons.

On receipt of recommendation of the Committee, It will be communicated his decision thereon to the Applicant within 10 days or such further time not exceeding 20 days, as may be considered necessary from the date of receipt of the recommendation and in case of non-acceptance of any recommendation, the reason of such non-acceptance shall also be ...

Additional Municipal Commissioner and/or Grievance Redressal Committee, if found, come to the conclusion that any such complaint or review is of vexatious, frivolous or malicious nature and submitted with the intention of delaying or defeating any procurement or causing loss to the procuring entity or any other bidder, then such complainant shall be punished with fine, which may extend to Five Lac rupees or two percent of the value of the procurement, whichever is higher.

SECTION 10
SPECIFICATIONS
&
SELECTION OF MATERIAL

SPECIFICATIONS & SELECTION OF MATERIAL

The tender is prepared on the basis of Unified Schedule of Rates and specifications 2018. The specifications of the items of USOR are available on BMCportal <http://portal.mcgm.gov.in> under the Tender tab. Hence the deserving contractor shall either download the same from BMCportal or the same may be collected in the soft copy format at the time of purchasing the tender from this office.

SELECTION OF MATERIAL

- 1) All materials brought on the site of work and meant to be used in the same, shall be the best of their respective kinds and to the approval of the Engineer. The Engineer or his representative will accept that the materials are really the best of their kinds, when it is proved beyond doubt that no better materials of the particular kind in question are available in the market.
- 2) The contractor shall obtain the approval of the Engineer of samples of all materials to be used in the works and shall deposit these samples with him before placing an order for the materials with the suppliers. The materials brought on the works shall conform in every respect to their approved samples. Fresh samples shall be deposited with the Engineer whenever the type or source of any material changes.
- 3) The contractor shall check each fresh consignment of materials as it is brought to the site of works to see that they conform in all respects to the Specifications of the samples approved by the Engineer, or both.
- 4) The Engineer will have the option to have any of the materials tested to find out whether they are in accordance with the Specifications and the Contractor will bear all expenses for such testing. All B bills, vouchers and test certificates, which in the opinion of the Engineer or his representative are necessary to convince him as to the quality of the materials or their suitability shall be produced for his inspection when required.
- 5) Any materials that have not been found to conform to the specifications will be rejected forthwith and shall be removed from the site by the contractor at his own cost within 24 hours.
- 6) The Engineer shall have power to cause the Contractors to purchase and use such materials from any particular source, as may in his opinion be necessary for the

proper execution of the work.

- 7) Notwithstanding the source, the sand shall be washed using sand washing machine before use.
- 8) Testing of all materials shall be carried, as per testing frequency specified in relevant specifications, standards, Quality assurance manual etc is mandatory. The testing of concrete used for structural works shall be tested for every pouring / casting day and as per relevant IS Codal provisions. The testing of steel materials used for structural works shall be done for every lot received on site and same shall be submitted to BMC before actual use on site.

If adequate no. of tests are not carried out the corresponding pro-rata quantity payment will be withheld/recovered if inadvertently paid, at any stage of the contract.

SECTION 11
FRAUD AND CORRUPT
PRACTICES

FRAUD AND CORRUPT PRACTICES

- The Applicants and their respective officers, employees, agents and advisers shall observe the highest standard of ethics during the Bidding Process. Notwithstanding anything to the contrary contained herein, the Authority may reject an Application without being liable in any manner whatsoever to the Applicant if it determines that the Applicant has, directly or indirectly or through an agent, engaged in corrupt practice, fraudulent practice, coercive practice, undesirable practice or restrictive practice in the Bidding Process.
- Without prejudice to the rights of the Authority under relevant Clause hereinabove, if an Applicant is found by the Authority to have directly or indirectly or through an agent, engaged or indulged in any corrupt practice, fraudulent practice, coercive practice, undesirable practice or restrictive practice during the Bidding Process, such Applicant shall not be eligible to participate in any tender or RFQ issued by the Authority during a period of 2 (two) years from the date such Applicant is found by the Authority to have directly or indirectly or through an agent, engaged or indulged in any corrupt practice, fraudulent practice, coercive practice, undesirable practice or restrictive practice, as the case may be.
- For the purposes of this Clause , the following terms shall have the meaning hereinafter respectively assigned to them:

(A) “**corrupt practice**” means the offering, giving, receiving, or soliciting, directly or indirectly, of anything of value to influence the actions of any person connected with the Bidding Process (for avoidance of doubt, offering of employment to, or employing, or engaging in any manner whatsoever, directly or indirectly, any official of the Authority who is or has been associated in any manner, directly or indirectly, with the Bidding Process or the LOA or has dealt with matters concerning the Concession Agreement or arising there from, before or after the execution thereof, at any time prior to the expiry of one year from the date such official resigns or retires from or otherwise ceases to be in the service of the Authority, shall be deemed to constitute influencing the actions of a person connected with the Bidding Process); **or**

save and except as permitted under the relevant sub clause, engaging in any manner whatsoever, whether during the Bidding Process or after the issue of the LOA or after the execution of the Concession Agreement, as the case may be, any person in respect of any matter relating to the Project or the LOA or the Concession Agreement, who at anytime has been or is a legal, financial or technical adviser of the Authority in relation to any matter concerning the Project;

- (B)** “**fraudulent practice**” means a misrepresentation or omission of facts or suppression of facts or disclosure of incomplete facts, in order to influence the Bidding Process ;
- (C)** “**coercive practice**” means impairing or harming or threatening to impair or harm, directly or indirectly, any person or property to influence any person's participation or action in the Bidding Process;
- (D)** “**undesirable practice**” means (i) establishing contact with any person connected with or employed or engaged by the Authority with the objective of canvassing, lobbying or in any manner influencing or attempting to influence the Bidding Process; or (ii) having a Conflict of Interest; and
- (E)** “**Restrictive practice**” means forming a cartel or arriving at any understanding or arrangement among Applicants with the objective of restricting or manipulating a full and fair competition in the Bidding Process.
- (F)** If the Employer/Financier determines that the Contractor has engaged in corrupt, fraudulent, collusive, coercive or obstructive practices, in competing for or in executing the Contract, then the Employer may, after giving 14 days' notice to the Contractor, terminate the Contractor's employment under the Contract and expel him from the Site, and the provisions of relevant Clause shall apply as if such expulsion had been made.
- (G)** Should any employee of the Contractor be determined to have engaged in corrupt, fraudulent, collusive, coercive, or obstructive practice during the execution of the Works, then that employee shall be removed in accordance with relevant Clause.

For the purposes of this Sub-Clause:

- i. “corrupt practice” is the offering, giving, receiving to soliciting, directly or indirectly, of anything of value to influence improperly the actions of another party;
- ii. “another party” refers to a public official acting in relation to the procurement process or contract execution. In this context, “public official” includes Financier staff and employees of other organizations taking or reviewing procurement decisions.
- iii. “fraudulent practice” is any act or omission, including a misrepresentation, that knowingly or recklessly misleads, or attempts to mislead, a party to obtain a financial or other benefit or to avoid an obligation;

- iv. “collusive practice” is an arrangement between two or more parties designed to achieve an improper purpose, including to influence improperly the actions of another party;
- v. “coercive practice” is impairing or harming, or threatening to impair or harm, directly or indirectly, any party or the property of the party to influence improperly the actions of a party;
- vi. “obstructive practice” is deliberately destroying, falsifying, altering or concealing of evidence material to the investigation or making false statements to investigators in order to materially impede the Financier investigation into allegations of a corrupt, fraudulent, coercive or collusive practice; and/or threatening, harassing or intimidating any party to prevent it from disclosing its knowledge of matters relevant to the investigation or from pursuing the investigation; or
- vii. acts intended to materially impede the exercise of the Financier’s inspection and audit rights provided.
- viii. “party” refers to a public official; the terms “benefit” and “obligation” relate to the procurement process or contract execution; and the “act or omission” is intended to influence the procurement process or contract execution.
- ix. “parties” refers to participants in the procurement process (including public officials) attempting to establish bid prices at artificial, noncompetitive levels.
- x. a “party” refers to a participant in the procurement process or contract execution.

SECTION 12
PRE BID MEETING

PREBID MEETING

Pre-Meeting will be applicable for the works costing more than Rs. 25 Crores.

Pre-bid meeting of the interested parties shall be convened at the designated date, time and place. A maximum of three representatives of each Applicant shall be allowed to participate on production of authority letter from the Applicant.

During the course of Pre-bid meeting, the Applicants will be free to seek clarifications and make suggestions for consideration of the Authority. The Authority shall Endeavour to provide clarifications and such further information as it may, in its sole discretion, consider appropriate for facilitating a fair, transparent and competitive Bidding Process.

SECTION –13
LIST OF APPROVED
BANKS

LIST OF APPROVED BANKS

The following Banks with their branches in Greater Mumbai and in suburbs up to Virar and Kalyan have been approved only for the purpose Banker's guarantee from 1997-98 onwards until further instructions.

The Bankers Guarantee issued by branches of approved Banks beyond Kalyan can be accepted only if the said Banker's Guarantee is countersigned by the branch of the same Bank, within the Mumbai Limit categorically endorsing said bankers Guarantee is binding on the endorsing Branch of the bank w limits and is liable to be on forced against the said branch of the Bank in case the contractor/supplier furnishing the bankers Guarantee.

List of approved Banks:- (Please refer Circular no. CA / FBK / 241 dt. 27.11.19)

A	SBI and its Subsidiary Banks
1	State Bank of India
2	State Bank of Bikaner & Jaipur
3	State Bank of Hyderabad
4	State Bank of Mysore
5	State bank of Patiyala
6	State Bank of Saurashtra
7	State Bank of Travancore
B	Nationalized Banks
8	Allahabad Bank
9	Andhra Bank
10	Bank of Baroda
11	Bank of India
12	Bank of Maharashtra
13	Central Bank of India
14	Dena Bank
15	Indian Bank
16	Indian Overseas Bank
17	Oriental Bank of Commerce
18	Punjab National Bank
19	Punjab & Sindh Bank
20	Syndicate Bank.
21	Union Bank of India
22	United Bank of India
23	UCO Bank
24	Vijaya Bank
24A	Corporation Bank

C	Scheduled Commercial Bank
25	Bank of Madura Ltd
26	Bank of Rajasthan Ltd
27	Banaras State Bank Ltd
28	Bharat Overseas bank
29	Catholic Syrian Bank Ltd
30	City Union bank Ltd
31	Development Credit Bank
32	Dhanalaxmi Bank Ltd.
33	Federal Bank Ltd
34	Indsind Bank Ltd
35	I.C.I.C.I. Banking Corporation Ltd
36	Global Trust Bank Ltd.
37	Jammu & Kashmir Bank Ltd.
38	Karnataka Bank Ltd.
39	KarurVysya Bank Ltd.
40	Laxmi Vilas Bank Ltd.
41	Nedugundi Bank Ltd.
42	Ratnakar Bank Ltd.
43	Sangli Bank Ltd.
44	South Indian Bank Ltd
45	S.B.I. Corporation & Int Bank Ltd.
46	Tamilnadu Mercantile Bank Ltd.
47	United Western Bank Ltd.
48	Vysya Bank Ltd.
D	Scheduled Urban Co-op Banks
49	Abhyudaya Co-op Bank Ltd
50	Bassein Catholic Co-op Bank Ltd
51	Bharat Co-op Bank Ltd
52	Bombay Mercantile Co-op Bank Ltd
53	Cosmos Co-op Bank Ltd
54	Greater Mumbai Co-op Bank Ltd
55	Janata Sahakari Bank Ltd
56	Mumbai District Central Co-op Bank Ltd
57	Maharashtra State Co-op Bank Ltd
58	New India Co-op Bank Ltd
59	North Canara GSB Co-op Bank Ltd
60	Rupee Co-op Bank Ltd
61	Sangli Urban Co-op Bank Ltd

62	Saraswat Co-op Bank Ltd
63	ShamraoVitthal Co-op Bank Ltd
64	MahaNagar Co-op Bank Ltd
65	Citizen Bank Ltd.
66	Yes Bank Ltd.
E	Foreign Banks
67	ABM AMRO (NY) Bank
68	American Express Bank Ltd.
69	ANZ Grinlays Bank Ltd
70	Bank of America N.T. & S.A.
71	Bank of Tokyo Ltd
72	Bankindosuez
73	BanqueNationale de Paris.
74	Barclays Bank
75	City Bank N.A.
76	Hongkong& Shanghai Banking Corporation.
77	Mitsui Taiyokbe Bank Ltd
78	Standard Chartered Bank
79	Cho hung Bank

SECTION -14
APPENDIX

FORM OF TENDER

To,
The Municipal Commissioner for Greater Mumbai
Sir,

I/ We have read and examined the following documents relating to the construction
of _____

-
- i. Notice inviting tender.
 - ii. Directions to tenderers (General and special)
 - iii. General condition of contract for Civil Works of the Brihanmumbai Municipal Corporation (BMC) as amended up to date.
 - iv. Relevant drawings
 - v. Specifications.
 - vi. Special directions
 - vii. Annexure A and B.
 - viii. Bill of Quantities and Rates.

1A. I/We _____
(full name in capital letters, starting with surname), the Proprietor/ Managing Partner/ Managing Director/ Holder of the Business, for the establishment / firm / registered company, named herein below, do hereby offer to
.....
.....
.....
.....
.....

Referred to in the specifications and schedule to the accompanying form of contract of the rates entered in the schedule of rates sent herewith and signed by me/ us” (strike out the portions which are not applicable).

- 1B. I/We do hereby state and declare that I/We, whose names are given herein below in details with the addresses, have not filled in this tender under any other name or under the name of any other establishment /firm or otherwise, nor are we in any way related or concerned with the establishment /firm or any other person, who have filled in the tender for the aforesaid work.”
2. I/We hereby tender for the execution of the works referred to in the aforesaid documents, upon the terms and conditions, contained or referred to therein and in accordance with the specifications designs, drawings and other relevant details in all respects.

* At the rates entered in the aforesaid Bill of Quantities and Rates.

3. According to your requirements for payment of Earnest Money amounting **to Rs.6,21,140.00/- (Six Lakhs Twenty One Thousand One Hundred & Forty Rupees only).**

I/We have deposited the amount through online payment gateways with the C.E. of the Corporation not to bear interest

4. I/We hereby request you not to enter into a contract with any other person/s for the execution of the works until notice of non/acceptance of this tender has first been communicated to me/us, and in consideration of yours agreeing to refrain from so doing I/we agree not to withdraw the offer constituted by this tender before the date of communication to me/us of such notice of non/acceptance, which date shall be not later than ten days from the date of the decision of the Standing Committee or Education Committee of the Corporation, as maybe required under the Mumbai Municipal Corporation Act, not to accept this tender.(Subject to condition 5 below).
5. I/We also agree to keep this tender open for acceptance for a period of 180 days from the date fixed for opening the same and not to make any modifications in its terms and conditions which are not acceptable to the Corporation.
6. I/We agree that the Corporation shall, without prejudice to any other right or remedy, be at liberty to forfeit the said earnest money absolutely, if.
- a. I/We fail to keep the tender open as aforesaid.
 - b. I/We fail to execute the formal contract or make the contract deposit when called upon to do so.
 - c. I/we do not commence the work on or before the date specified by the Engineer in his work order.
7. I/We hereby further agree to pay all the charges of whatsoever nature in connection with the preparation, stamping and execution of the said contract.
8. I/We further agree that, I/we shall register ourselves as 'Employer' with the Bombay Iron and Steel Labour Board' and fulfill all the obligatory provisions of Maharashtra Mathadi, Hamal and other Manual workers (Regulation of Employment and Welfare) Act 1969 and the Bombay Iron and Steel unprotected workers Scheme 1970.
9. "I/We..... have failed in the accompanying tender with full knowledge of liabilities and, therefore, we will not raise any objection or dispute in any manner relating to any action, including forfeiture of deposit and blacklisting, for giving any information, which is found to be incorrect and against the instructions and directions given in this tender.
10. "I/We further agree and undertake that in the event it is revealed subsequently after the allotment of work/contract to me/us, that any information given by me/us in this tender is false or incorrect, I/We shall compensate the Brihanmumbai Municipal Corporation (BMC) for any such losses or inconvenience caused to the Corporation in any manner and will not resist any claim for such compensation on any ground whatsoever. I/we agree and undertake that I/we shall not claim in such case any

amount by way of damages or compensation for cancellation of the contract given to me/us or any work assigned to me/us or is withdrawn by the Corporation,”

Address

Yours

faithfully,

.....

.....

Digital Signature of the Tenderer or

the Firm

1.....

2.....

3.....

4.....

5.....

Full Name and private residential address of all the partners constituting the Firm

A/c No.

.....

1.

Name of Bank

2.

.....

3.

Name of Branch

4.

.....

5. Vender No.

AGREEMENT FORM

Tender / Quotation:- _____ dated 20...

Standing Committee/Education Committee Resolution No.
.....

CONTRACT FOR THE WORK
.....
.....
.....

This agreement made this day of Two
thousand
Between
.....
.....

...
inhabitants of Mumbai, carrying on business at.....

.....
in Bombay under the style and name of Messrs

... (Hereinafter called "the contractor of the one part and Shri

.....
the Director(E.S.&P.) (hereinafter called "the commissioner" in which expression are included unless the inclusion is inconsistent with the context, or meaning thereof, his successor or successors for the time being holding the office of Director (E,S.& P)of the second part and the Brihanmumbai Municipal Corporation (BMC)(hereinafter called "the Corporation") of the third part, WHEREAS the contractor has tendered for the construction, completion and maintenance of the works described above and his tender has been accepted by the Commissioner (with the approval of the Standing Committee/Education Committee of the Corporation NOW THIS

THIS AGREEMENT WITNESSETH as follows:-

- 1) In this agreement words and expressions shall have the same meanings as are respectively assigned to them in the General Conditions of Contract for works hereinafter referred to:-
- 2) The following documents shall be deemed to form and be read and constructed as a part of this agreement viz.
 - a) The letter of Acceptance
 - b) The Bid:
 - c) Addendum to Bid; if any
 - d) Tender Document

- e) The Bill of Quantities:
 - f) The Specification:
 - g) Detailed Engineering Drawings
 - h) Standard General Conditions of Contracts (GCC)
 - i) All correspondence documents between bidder and BMC
- 3) In consideration of the payments to be made by the Commissioner to the contractor as hereinafter mentioned the contractor hereby covenants with the Commissioner to construct, complete and maintain the works in conformity in all respects with the provision of the contract.
- 4) The Commissioner hereby covenants to pay to the Contractor in consideration of the construction, completion and maintenance of the works the contract sum, at times and in the manner prescribed by the contract.

IN WITNESS WHERE OF the parties hereto have caused their respective common seals to be herein to affixed (or have hereunto set their respective hands and seals) the day and year above written.

Signed, Sealed and delivered by the contractors

In the presence of

Trading under the name and style of

Full Name
 Address

Contractors

Signed by the Director (ES&P) in the presence of

Ex. City/ WS/ ES

Director (ES&P)

The Common seal of the Brihanmumbai Municipal Corporation (BMC) Mumbai was hereunto affixed on the 20 in the presence of two members of the Standing Committee.

1.

1.

2.

2.

And in the presence of the Municipal Secretary

Annexure-A
Irrevocable Undertaking

e-tender no. _____

(on Rs.500/-stamp paper)

I shri/Smt.....aged,.....years Indian inhabitant. Proprietor /Partner/Director of M/s.resident at do hereby give Irrevocable undertaking as under;

- 1) I say & undertake that as specified in section 171 of CGST Act, 2017, any reduction in rate of tax on supply of goods or services or the benefit of input tax credit shall be mandatorily passed on to BMC by way of commensurate reduction in prices.
- 2) I further say and undertake that I understand that in case the same is not passed on and is discovered at any later stage, BMC shall be at liberty to initiate legal action against me for its recovery including, but not limited to, an appeal to the screening Committee of the GST Counsel.
- 3) I say that above said irrevocable undertaking is binding upon me/my partners/company/other Directors of the company and also upon my /our legal heirs, assignee, Executor, administrator etc.
- 4) If i fail to compliance with the provisions of the GST Act, I shall be liable for penalty/punishment or both as per the provisions of GST Act.

Whatever has been stated here in above is true & correct to my /our own knowledge & belief.

Solemnly affirmed at

DEPONENT

This day of

BEFORE ME

ANNEXURE 'A-I'

Name of the Work :	E - Tender No. - _____ ES - _____ Training and Widening of Laxmibaug nalla at Sidhrameshwar Nagar, Ghatkopar(E) in N Ward. (Brimstowad work).
--------------------	---

1.	Engineer for this work	Chief Engineer (S.W.D.)
		Dy.Ch. Engineer (S.W.D.) E.S.
		Ex. Engineer (S.W.D.) E.S. Zone-VI

2.	Estimated Cost of Tender	Rs.6,21,13,614.00/-
Sr. no	Description of Work	Total Amount Rs.
a)	Civil Work	Rs.6,21,13,614.00/-
b)	Electrical Work	N.A
c)	Total Amount	Rs.6,21,13,614.00/-

3.	Earnest Money (1% of Estimated Cost)	Rs. .6,21,140.00/-
----	--------------------------------------	---------------------------

4.	Time Period	
	Contract as a whole period Completion :	6 Months (Excluding Monsoon)
	Part or Group of items	Not Applicable

5. Percentage to be charged as supervision charges for the work got executed through other means **15 percent**.

6. The "Actual cost of the work" shall mean in the case of percentage rate contracts the actual cost of the work executed at the rates as mentioned in the Contract Schedule adjusted by the Contractor's percentage rate and cost of extra and excess, but excluding the cost on account of Water Charges and Sewerage Charges if any, payable by the contractor and also excluding cost on account of price variation claims as provided in price variation clause as amended up to date.
7. In case of item rate contracts the actual cost calculated for the work executed at the rates mentioned in the contract schedule for different items including cost of excess and extra items of the work excluding the cost of water charges and sewerage charges if any, payable by the contractor and excluding cost on account of price variation claims as provided in extra excess conditions as amended up to date.
8. In case of lump sum contract the cost of the work actually carried out as per break up and programme of the work and the schedule of payment included in the contract including cost of any excess and/or extra items, of the work, excluding the cost on account of water charges and sewerage charges and also excluding cost on account of price variation claims as provided in extra excess conditions as amended up to date.

Annexure-B
PRE-CONTRACT INTEGRITY PACT

e-tender no. _____

(On Rs. 500/- Stamp Paper)

The Bidder commits himself to take all measures necessary to prevent corrupt practices, unfair means and illegal activities during any stage of his bid or during any pre-contract or post-contract stage in order to secure the contract or in furtherance to secure it and in particular commits himself to the following:-

1. The Bidder will not offer, directly or through intermediaries, any bribe, gift, consideration, reward, favour, any material or immaterial benefit or other advantage, commission, fees, brokerage or inducement to any official of the BMC, connected directly or indirectly with the bidding process, or to any person, organization or third party related to the contract in exchange for any advantage in the bidding, evaluation, contracting and implementation of the Contract.
2. The Bidder further undertakes that he has not given, offered or promised to give, directly or indirectly any bribe, gift, consideration, reward, favour, any material or immaterial benefit or other advantage, commission, fees, brokerage or inducement to any official of the BMC or otherwise in procuring the Contract or forbearing to do or having done any act in relation to the obtaining or execution of the Contract or any other Contract with the Government for showing or forbearing to show favour or disfavour to any person in relation to the Contract or any other Contract with the Government.
3. The Bidder will not collude with other parties interested in the contract to impair the transparency, fairness and progress of the bidding process, bid evaluation, contracting and implementation of the contract.
4. The Bidder will not accept any advantage in exchange for any corrupt practice, unfair means and illegal activities.
5. The Bidder, either while presenting the bid or during pre-contract negotiations or before signing the contract, shall disclose any payments he has made, is committed to or intends to make to officials of the BMC or their family members, agents, brokers or any other intermediaries in connection with the contract and the details of services agreed upon for such payments.
6. The Bidder shall not use improperly, for purposes of competition or personal gain, or pass on to others, any information provided by the BMC as part of the business relationship, regarding plans, technical proposals and business details, including information contained in any electronic data carrier. The Bidder also undertakes to exercise due and adequate care lest any such information is divulged.
7. The Bidder commits to refrain from giving any complaint directly or through any

other manner without supporting it with full and verifiable facts.

8. The Bidder shall not instigate or cause to instigate any third person to commit any of the actions mentioned above.
9. The Bidder and their respective officers, employees, agents and advisers shall observe the highest standard of ethics during the Bidding Process. Notwithstanding anything to the contrary contained herein, the Authority may reject an Application without being liable in any manner whatsoever to the Applicant if it determines that the Applicant has, directly or indirectly or through an agent, engaged in corrupt practice, fraudulent practice, coercive practice, undesirable practice or restrictive practice in the Bidding Process

For the purposes of this Clause 9, the following terms shall have the meaning herein after respectively assigned to them:

1. "fraudulent practice" means a misrepresentation or omission of facts or suppression of facts or disclosure of incomplete facts, in order to influence the Bidding Process ;
2. "coercive practice" means impairing or harming or threatening to impair or harm, directly or indirectly, any person or property to influence any persons participation or action in the Bidding Process;
3. "undesirable practice" means (i) establishing contact with any person connected with or employed or engaged by the Authority with the objective of canvassing, lobbying or in any manner influencing or attempting to influence the Bidding Process; or (ii) having a Conflict of Interest; and
4. "restrictive practice" means forming a cartel or arriving at any understanding or arrangement among Applicants with the objective of restricting or manipulating a full and fair competition in the Bidding Process.

Signature of Tenderer/Bidder

Annexure- C
(On Rs. 500/- Stamp Paper)

DECLARATION CUM INDEMNITY BOND

e-tender no. _____

I, _____ of _____, do hereby declared and undertake as under.

1. I declare that I have submitted certificates as required to Executive engineer (Monitoring) at the time of registration of my firm/company _____ and there is no change in the contents of the certificates that are submitted at the time of registration.
2. I declare that I _____ in _____ capacity as Manager/Director/Partners/Proprietors of _____ has not been charged with any prohibitory and /or penal action such as banning(for specific time or permanent)/de-registration or any other action under the law by any Government and/or Semi Government and/or Government undertaking.
3. I declare that I have perused and examined the tender document including addendum, condition of contract, specifications, drawings, bill of quantity etc. forming part of tender and accordingly, I submit my offer to execute the work as per tender documents at the rates quoted by me in capacity as ___ of ____.
4. I further declare that if I am allotted the work and I failed to carry out the allotted work in accordance with the terms and conditions and within the time prescribed and specified, BMC is entitled to carry out the work allotted to me by any other means at my risk and cost, at any stage of the contract.
5. I also declare that I will not claim any charge/damages/compensation for non availability of site for the contract work at any time.
6. I declare that I will positively make the arrangements of the required equipment on the day of commencement or with respect to the progress of the work in phases, as per the instructions of site in charge
7. I Indemnify Municipal Commissioner and the other officers of BMC or their agents for any Damages, Loss or Injury, any legal suit, proceeding or legal action whatsoever that may be caused at any time by me or any other staff of _____ company, for the work undertaken and all such damage, damages, injury or loss, legal suit, legal action, I shall be
solely responsible in individual as well as official capacity and such loss, damages, injury shall be made good and/or as the case may be shall be paid immediately by me/company to the satisfaction of the BMC.
8. I indemnify BMC and all of its officers against the issues related with dumping sites and the disposal of desilted material as well as any accident/untoward event on site. Neither BMC staff shall be held responsible nor shall BMC be made party in any litigation.

Signature of Tenderer/Bidder

BANKERS GURANTEE IN LIEU OF CONTRACT DEPOSIT

THIS INDENTURE made this ___ day of _____ BETWEEN

THE _____ BANK incorporated under the English/Indian Companies Acts and carrying on business in Mumbai (hereinafter referred to as 'the bank' which expression shall be deemed to include its successors and assigns)of _____ the _____ first _____ part

_____Inhabitants carrying on business at _____ in Mumbai under the style and name of M/s. _____

_____ (hereinafter referred to as 'the consultant') of the second part Shri. _____

THE MUNICIPAL COMMISSIONER FOR GREATER MUMBAI (hereinafter referred to as 'the commissioner' which expression shall be deemed, also to include his successor or successors for the time being in the said office of Municipal Commissioner) of the third part and The Brihanmumbai Municipal Corporation (BMC) (hereinafter referred to as 'the Corporation') of the fourth part WHEREAS the consultants have submitted to the Commissioner tender for the execution of the work of " _____ and the terms of such tender /contract require that the consultants shall deposit with the Commissioner as/contract deposit

/ earnest money and /or the security a sum of Rs. _____ (Rupees _____) AND WHEREAS if and when any such tender is accepted by the Commissioner, the contract to be entered into in furtherance thereof by the consultants will provide that such deposit shall remain with and be appropriated by the Commissioner towards the Security - deposit to be taken under the contract and be redeemable by the consultants, if they shall duly and faithfully carry out the terms and provisions of such contract and shall duly satisfy all claims properly chargeable against them there under AND WHEREAS the consultants are constituents of the Bank and in order to facilitate the keeping of the accounts of the consultants, the Bank with the consent and concurrence of the consultants has requested the Commissioner to accept the undertaking of the Bank hereinafter contained, in place of the contractors depositing with the Commissioner the said sum as earnest money and /or security as aforesaid AND WHEREAS accordingly the Commissioner has agreed to accept such undertaking NOW THIS AGREEMENT WITNESSES that in consideration of the premises, the Bank at the request of the consultants (hereby testified) UNDERTAKES WITH the commissioner to pay to the commissioner upon demand in writing , whenever required by him , from time to time , so to do , a sum not exceeding in the whole Rs. _____ (Rupees _____) under the terms of the said tender and /or the contract .The B.G. Is valid upto _____ "Notwithstanding anything what has been stated above, our liability under the above guarantee is restricted to Rs. _____ only and guarantee shall remain in force upto _____ unless the demand or claim under this guarantee is made on us in writing on or before _____ all your right under the above guarantee shall be forfeited and we

shall be released from all liabilities under the guarantee thereafter”

IN WITNESS WHEREOF

WITNESS (1) _____

Name_____

address_____

WITNESS (2)_____

Nameand_____the duly constitutedAttorneyManager

address_____

the Bank and the saidMesser's_____

_____(Name oftheBank)

WITNESS(1)_____

Nameand_____

address _____

WITNESS(2)_____

Nameand_____

ForMesser's_____

address_____

have here into set their respective hands the day and year first above written.

The amount shall be inserted by the Guarantor, representing the Contract Deposit in Indian Rupees.

Annexure –D

Rate Analysis

Item Description:

Sr	Description of Rate Analysis Parameters	Unit	Quantity	Rate	Amount
1	Basic Material (Rate should be inclusive of all taxes)				
2	Machinery Hire Charges				
3	Labour Type		(Labour Components)		
4	Total of all Components				
5	Overhead & Profit 15% on 4				
6	Total Rate (4+5)				
7	Per unit Rate				

Sign and seal of the Tenderer

:PROFORMA :

PROFORMA-I

The List of similar works as stated in Para 'A' of Post Qualification during last **seven years:-**

PROFORMA-I					
Sr.	Name of Project	Name of Employer	Stipulated date of Completion	Actual Date of Completion	Actual Cost of Work done
1	2	3	4	5	6

Note:

- a) Scanned Attested Copies of Completion/Performance certificates from the Engineer-in-Charge for each work should be annexed in the support of information furnished in the above proforma.
- b) Works shall be grouped financial year-wise.

PROFORMA-II

Yearly Turnover of Civil Engineering Construction works during last **five years.**

PROFORMA-II					
Sr	Financial Year	Annual Turnover of Civil Engineering works	Updated value to Current year	Average of last 5 years	Page No.
1					
2					
3					
4					
5					
TOTAL					

Note: The above figures shall tally with the Audited Balance Sheets uploaded by the

tenderers duly certified by Chartered Accountant.

PROFORMA-III

At least Similar work, as stated in Para 'A' of Post Qualification.

PROFORMA-III							
Name of the project	Name of the Employer	Cost of the Project	Date of issue of Work Order	Stipulated Date of Completion	Actual Date of Completion	Actual cost of work done	Remarks explaining reasons for delay , if any
1	2	3	4	5	6	7	8

Note: Scanned Attested Copies of Completion/Performance certificates from the Engineer-in-Charge for each work should be annexed in the support of information furnished in the above proforma.

PERSONNEL : PROFORMA-IV

PROFORMA-IV					
Sr.	Post	Name (Prime Candidate /Alternate)	Qualification	Work Experience	
				No. of years	Name of Project
1	Project Manager				
2	Quality Control Engineer				
3	Site Engineer				
4	Site Supervisor				

NOTE: Scanned Attested copies of qualification certificates and details of work experience shall be submitted /uploaded.

MACHINERY :(For Special Work only)

PROFORMA-V/A			
Sr.	Equipment	Number	Owned/Leased/Assured Access
1	2	3	4

PROFORMA-V/B			
Sr.	Equipment	Number	Owned
1	2	3	4

Note :The tenderers shall furnish/upload the requisite Scanned Attested documents of Ownership/leased of Machineries. The undertaking from the suppliers will not be accepted.

PROFORMA-VI/A :Details of Existing Commitments and Ongoing Works

PROFORMA-VI/A							
Description of the Work	Place	Contract No. & Date	Name & Address of the Employer	Value of Contract in Rs.	Scheduled date of Completion	Value of work remaining to be completed	Anticipated date of completion
1	2	3	4	5	6	7	8

Note: Scanned Attested Copies of Completion/Performance certificates from the Engineer-in-Charge for each work should be annexed in the support of information furnished in the above proforma.

PROFORMA-VI/B :Details of works for which bids are already uploaded-

PROFORMA-VI/B						
Description of the Work	Place	Name & Address of the Employer	Value of Contract in Rs.	Time Period	Date on which decision is expected	Remarks
1	2	3	4	5	6	7

Note: Scanned Attested Copies of certificates from the Engineer-in-Charge for each work should be annexed in the support of information furnished in the above proforma.

PROFORMA-VII : LITIGATION HISTORY

Other Party (ies)	Employer	Cause of Dispute	Amount involved.	Remarks showing Present Status.
1	2	3	4	5

Annexure –E

“Barricading shall be provided free of cost as per Circular vide U/No. MGC/F/ 6342 dated 5.5.2018 and as per Annexure I, II and III of Standard drawings and specifications with slogans and department wise colour codes.” The copy of circular is attached herewith as part of tender document.

SPECIFICATIONS FOR ITEMS OF BARRICADING. Barricading shall be as per circular No MGC-F-6342 dated 05.05.2018 (copy uploaded with this tender) and as per the new design (copy uploaded with this tender). It will be binding on the qualifying bidder/agency to install the GPS trackers at the starting and end barricades provided along each work site. The installed GPS trackers shall be kept in working condition till the completion of the works. While shifting the barricades care shall be taken to keep the GPS tracker barricades at the site if the work is not completed. Further, The QR Code shall be provided on each panel of barricades and shall following information of the sites Viz. name of work, name of the contractors, name of all contractor’s staff appointed for this particular project, Date of start and completion of the work, etc., and as required by Engineer-In-charge. Each Barricade shall have LED rope lighting which shall be kept on between sunset and sunrise or as directed by engineer-incharge. Any innovative design/slogan/message as directed by the Engineer incharge shall be displayed on said barricade. No extra payment will be made for the installation of the barricades or for providing the design/slogan/message/reflectors or the LED lighting or the installed GPS trackers as stated; contractors shall note the same and quote accordingly. The cost of power supply to the LED rope light shall be borne by the contractor and he shall quote the bid accordingly.

If barricades are not provided as per specification, the following penalties will be levied:

Sr.no.	For each Instance at each road	Penalty in Rs. Per Day
1	1 st instance	5,00,000/-
2	From 2nd instance onwards	10,00,000/-

Penalty will be proposed by SE and AE and approved by Engineer-in-charge E.E.(SWD).

MUNICIPAL CORPORATION OF GREATER MUMBAI

CIRCULAR

U/No.MGC/F/6342 dated 5.5.2018

Sub.: Revised guidelines regarding barricades being used during the execution of various infrastructure development projects by MCGM in Mumbai.

Various infrastructure development projects are being executed by MCGM for the betterment of citizens of Mumbai. During the course of execution of the projects, it is necessary to provide strong and secured barricading as a safety measure to avoid any mishaps as well as to avoid nuisance to vehicular and pedestrian traffic. Nowadays, the following types of barricades are being used exclusively in MCGM as per the convenience of various departments at different sites.

1. Water/sand fillable PVC Metro barricades.
2. RW 7.45 (G.I. sheets of 22 gauge fixed on 3 inch dia. Wooden bullies buried in existing road sufficiently)
3. RW 7.36 (G.I. sheets of 22 gauge fixed on MS Angle post buried in half the depth in drums of 20 litres capacity in 1:3:6 concrete)
4. Structural steel barricade for major trenches having depth more than 2.00 meters.

Thus from the above, it can be seen that there is no uniformity in provision of barricades as they are of different size and shape. Further it is also observed that the continuity is not maintained in providing the barricading keeping gaps in between thus endangering the safety of vehicular as well as pedestrian traffic. Also the barricades are not being cleaned, thus further adding to shabbiness. Further Mumbai being the financial capital of India, people from all over the world visit the city daily and to maintain good image of city the following decisions are taken.

-
- A) Only two type of barricades having department wise colour coding are proposed to be used depending upon the nature of work i.e. Minor and Major.
- i) **Minor works:** Barricading made out of 1.5 mm thick MS plate fixed on M.S. angle post/ frame of 65 mm X 65 mm X 6 mm having height of 1.5 m supported on as shown in Annex-I.
- ii) **Major works:** Structural steel barricade made out of 1.50 mm thick M.S. Plate ISMB 250, ISLC 250X50mm and ISA 50mmX50mmX6 mm having of size 2.5 m X 2 m as shown in Annex-II.
- B) The department wise colour coding for the barricading shall be as under:-
- i) H.E. & W.S.P. department – **Blue**
- ii) Roads, Traffic, Bridges and Coastal Roads department– **Yellow**
- iii) S.P. & S.O department – **Green**
- iv) S.W.D., Building Maintenance department & for ward works – **Red**
- C) The basic principle behind installing secured and continuous barricading is to ensure the safety of vehicular as well as pedestrian traffic and residents in the nearby vicinity of the project. Due to non-installation of appropriate barricades on sites if any mishap occurs leading to injury or loss of life, then the contractor and contractor's Engineer in-charge will be liable for the consequent action.
- D) During the course of execution of project, if it is noticed that the contractor has not provided barricading then a penalty of Rs.1000/- per meter per day will be imposed upon the contractor and will be deducted from the due Bill. This penalty shall be a part of penalty as per tender condition.
- E) Details of the work shall be prominently displayed on the central panel of the barricades along-with the Social Slogans as given in Annexure III and the Cycle of the same shall be maintained.
- F) The contractor shall provide and install the barricading alongwith the slogans printed as per the Annexure III, at his own cost and no payment will be made for this, however the contractor shall quote the bid accordingly by considering the cost of barricading.

The condition shall be included in the tender as given below. “
Barricading shall be provided free of cost as per Circular vide U/No.MGC/F/6342 dated 5.5.2018 and as per Annexure I, II and III of Standard drawings and specifications with slogans and department wise colour codes.” The copy of circular will be attached to the tender as a part of tender document.

This circular will be applicable for the new tenders proposed to be invited from 01.06.2018 and also the corrigendum shall be attached to tenders which are uploaded. However, for the projects wherein the tenders are already invited, the barricading shall be provided strictly as per tender condition. All the details (Annexure I, II & III of Standard drawings and specifications with slogans and department wise colour codes, sketches and department wise colour coding) are uploaded on MCGM portal.

This circular shall come in force with immediate effect.

sd/- 20.4.2018
(Shri V.P . Chithore)
Dir.(ES&P)

sd/- 20.4.2018
(Shri R. B. Bambale)
D.M.C.(S.E.)

sd/- 21.4.2018
(Shri Vijay Singhal)
A.M.C.(E.S.)

sd/- 21.4.2018
(Dr. Shri Sanjay Mukherjee)
A.M.C.(P.)

sd/- 5.5.2018
(Shri Ajoy Mehta)
M. C.

sd/- 16.5.2018
(Shri V.P . Chithore)
Dir.(ES&P)

sd/- 16.5.2018
(Shri P. R. Kadam)
D.M.C.(S.E.)

ANNEXURE I

A) Minor work

Providing, fabricating and installing the barricading made out of 1.5 m high M.S. Angle post of 65 mm X 65 mm X 6 mm with 1.5 mm thick M.S. Sheet of size 1.55 m X 1.2 m welded to the M.S. angle post/ frames and fixed to 75mm X 75mm X 6 mm angle base as shown in sketch for minor works , displaying of the social slogan as per the Annex - III, daily cleaning of the same to get better appearance and interlocking arrangement to ensure continuity in provision and to avoid gap in between etc complete and as directed by Engineer in-charge.

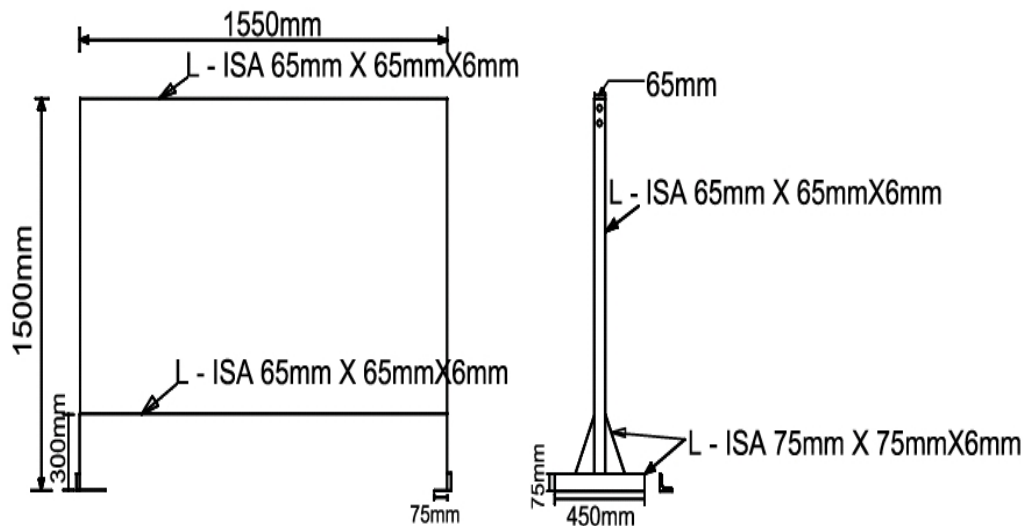

ANNEXURE II

B) Major works:

Providing, fabricating and installing the structural steel barricading made out of 1.5 mm thick M.S. plate of size 2500 mm X 2000 mm, ISMC 250 X 50 channels, M.S. Angles ISA 50 X 50 X 6mm and ISMB 250 as per IS 1161-1 RHS/SHS rolled angle plates of TATA Steel, Lloyd Steel, SAIL, ESSAR steel approved in straight profile of all sizes, shapes and for all works including stiffeners, bolts and nuts, fillet / butt welding, splicing, machine grinding, of all member joints wherever required to give neat appearance, and daily cleaning the barricading along with displaying of the Depthwise slogans as given in Annexure -III etc with interlocking arrangement to avoid gap in between and as directed by Engineer in-charge.

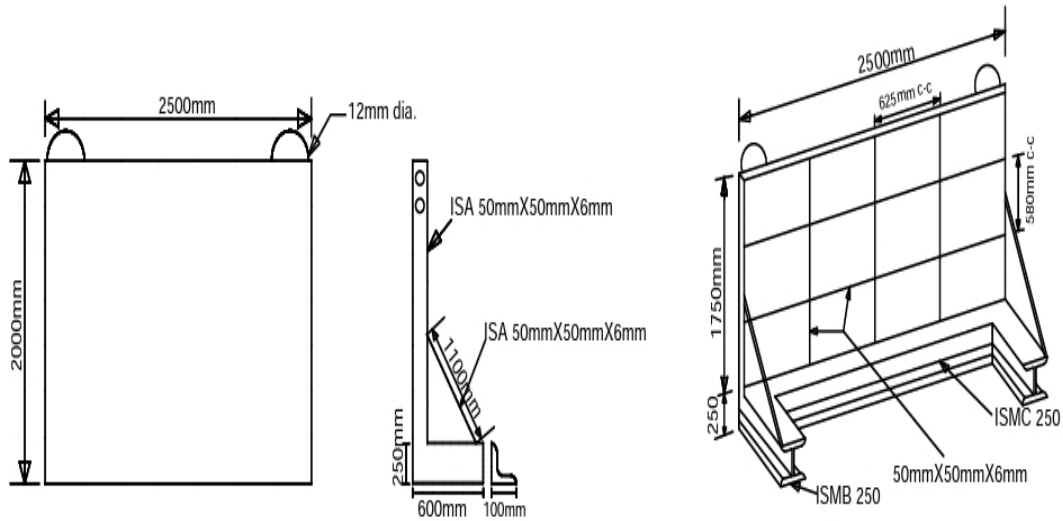

ANNEXURE III

1) HYDRAULIC ENGINEER'S DEPARTMENT/ WATER SUPPLY PROJECTS

- i) Inconvenience regretted
- ii) Ensuring Mumbai's water supply
- iii) Save water Save life

2) ROAD, TRAFFIC / BRIDGES DEPARTMENT

- i) Inconvenience regretted
- ii) Working towards a better tomorrow
- iii) My Mumbai, Green Mumbai

3) SEWERAGE PROJECTS DEPARTMENT/ SEWERAGE OPERATIONS DEPARTMENT

- i) Inconvenience regretted
- ii) Reduce Reuse Recycle
- iii) Clean Mumbai , healthy Mumbai

4) STORM WATER DRAIN DEPARTMENT/ WARD WORKS

- i) Inconvenience regretted
- ii) Working towards a better tomorrow
- iii) Swatch Bharat

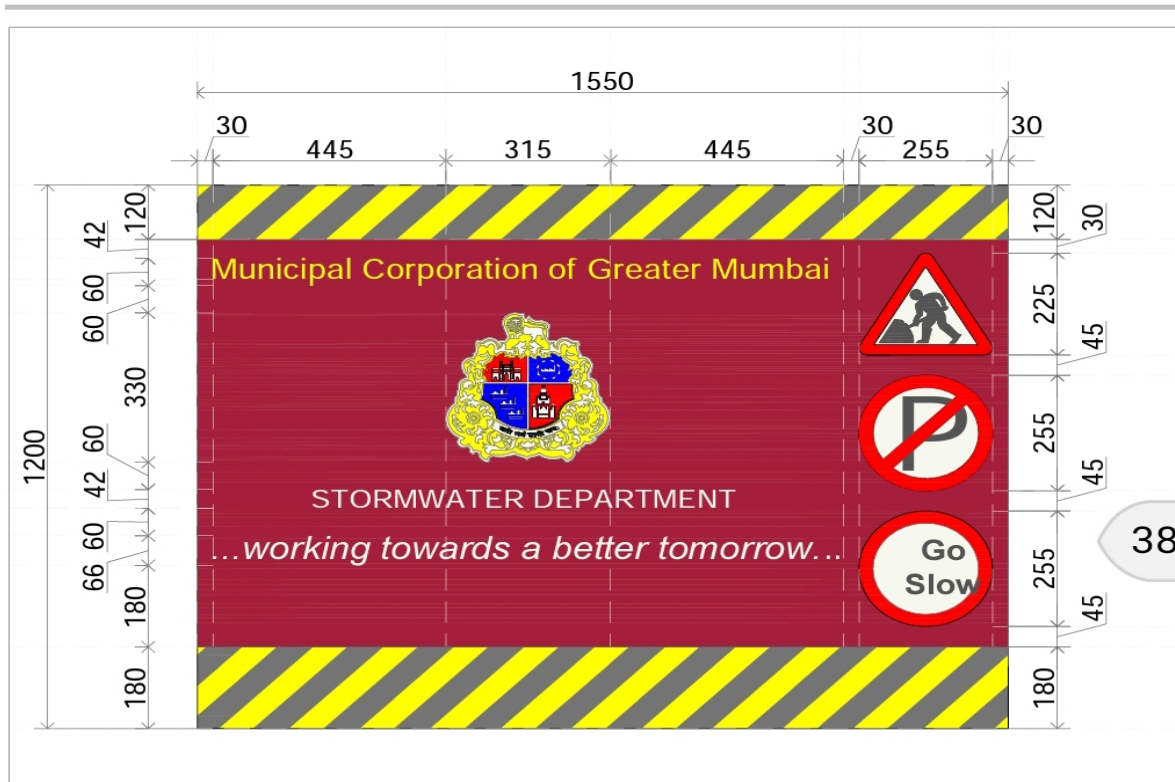

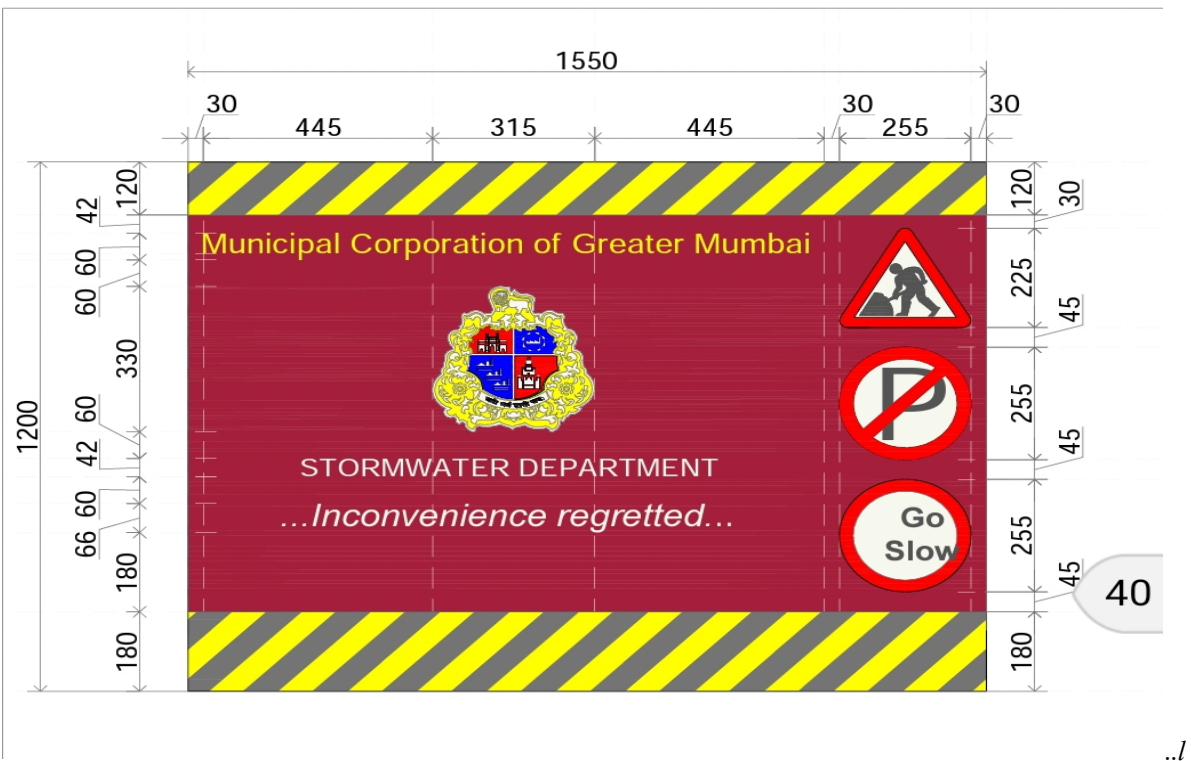

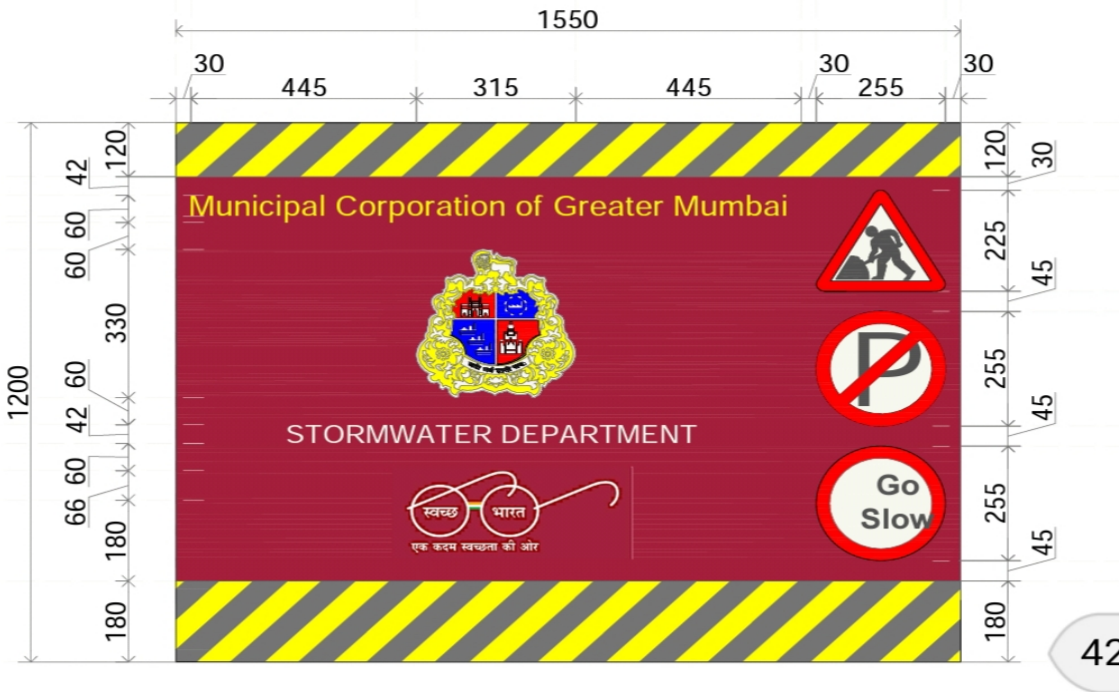
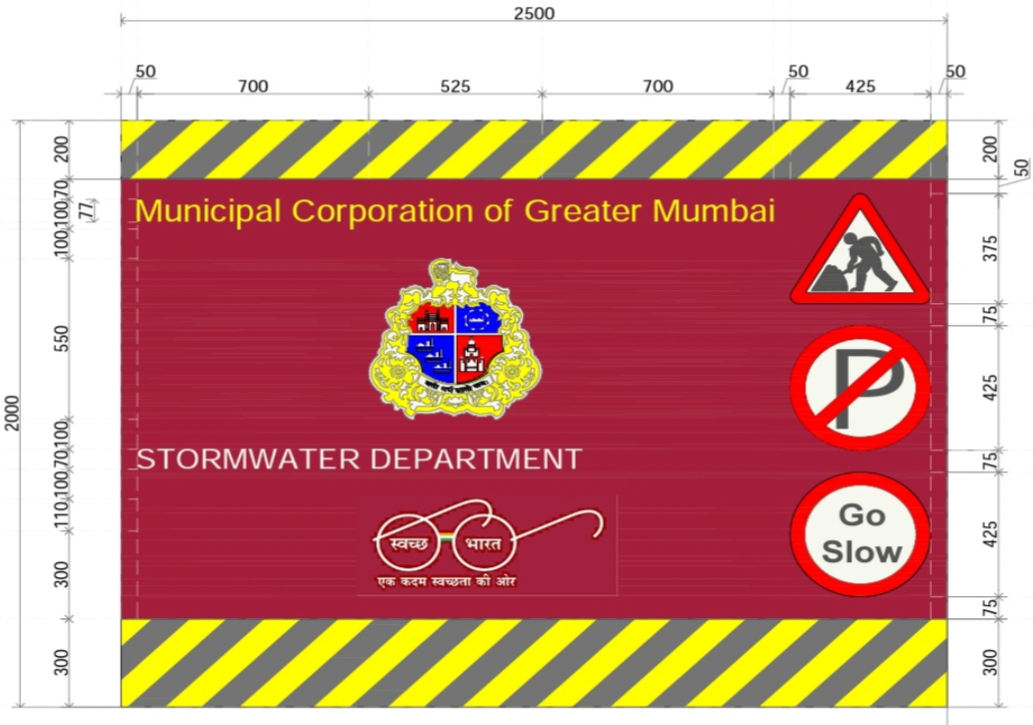

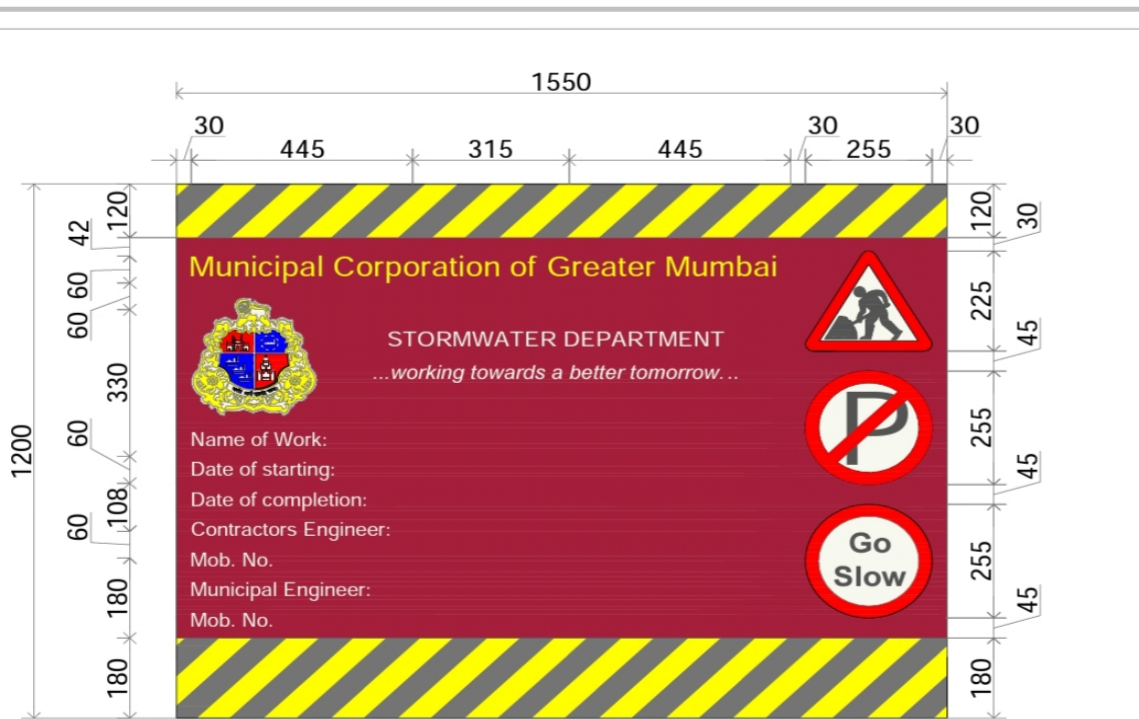

Annexure –F

- **List of Approved Asphalt Plants:**

Tenderer(s) shall arrange to bring asphalt mixes from approved plants registered with B.M.C., during the execution of the work. **The valid list of approved asphalt plants at “the time of execution of works” to be obtained from the Dy.Ch.Engineer (Roads)City office.**

The Municipal Site Engineer to ensure the validity of registration certificate of asphalt plant and compliance of conditions laid down in the registration certificate issued to the asphalt plant owner` before receiving asphalt mixes.

- **List of approved manufacturer of interlocking paver blocks**

Tenderer(s)hall arrange to bring Interlocking Paver Block from approved plants registered with B.M.C., during the execution of the work. **The valid list of approved paver blocks manufacturers plants at “the time of execution of works” to be obtained from the Dy.Ch.Engineer (Roads)City office.**

The Municipal Site Engineer to ensure the validity of registration certificate of paver block plant and compliance of conditions laid down in the registration certificate issued to the paver block plant owner before receiving paver blocks.

- **List of approved R.M.C. Plants**

Tenderer(s)hall arrange to bring RMC mixes from approved plants registered with B.M.C., during the execution of the work. **The valid list of approved R.M.C. plants at “the time of execution of works” to be obtained from the Dy.Ch.Engineer (Rds)E.S.'s office.**

The Municipal Site Engineer to ensure the validity of registration certificate of RMC plant and compliance of conditions laid down in the registration certificate issued to the RMC plant owner before receiving RMC mixes.

- **LIST OF THE APPROVED MANUFACTURERS FOR SUPPLYING M-35 GRADE PRECAST KERB STONES ANDWATER TABLES**

Sr. No	Name & Address of the manufacturer	Location of RMC Plant/ Place of manufacturing
1.	M/s.Surface Road Constructions, D-30/004, Yogi Vaibhav CHS Ltd., Yogi Nagar, Eksar Road, Borivali(W),MUMBAI – 400 091. Ph.No.30903429/982127744	Plot No.472, Opp. Text Tube Factory, Nr. Garuda Petrol Pump, Charkop Industrial Estate, Kandivili (W),MUMBAI – 400 091.

2.	M/s. Unity Infraprojects Ltd. 1252, Pushpanjali Apartment, 1st floor, Old Prabhadevi Road, Prabhadevi, <u>MUMBAI-400025.</u>	MMRDA Plot, Phase IV, Wadala Truck Terminal, Wadala, MUMBAI - 400 034.
3.	M/s. Magnum Const. C-107, Shyamkamal, Agarwal Market, Tejpal Road, Vile Parle (East), <u>MUMBAI- 400 057.</u>	Behind Diamond Ind. Estate, Ahead of Dahisar Toll Naka, Ketkipada, Dahisar (E), MUMBAI-
4.	Relcon Infraprojects Pvt. Ltd., 105/C, Shyam Kamal, 1 st floor, Agarwal Market, Vile Parle (East), <u>MUMBAI- 400 057.</u>	BEST Plot, Kandarpada, Dahisar (W), Mumbai,
5.	M/s. Shree Constructions, 8/44, Vineet Nagar, Cotton Green, <u>MUMBAI- 400 033.</u>	Tembhode village, New Panvel, Dist. Raigad

Note : The valid list at the time of execution of works can be obtained from the Dy.Ch.Eng. (Roads) E.S.'s office.

- **LIST OF THE APPROVED MANUFACTURERS FOR SUPPLYING M-25 GRADE PRECAST FRAME & COVERS AND M 35 GRADE DIVIDERS (CENTRE MEDIAN)**

Sr. No.	Name & Address of the manufacturer	Location of RMC Plant/ Place of manufacturing
1.	Relcon Infraprojects Pvt. Ltd., 105/C, Shyam Kamal, 1 st floor, Agarwal Market, Vile Parle (East), <u>MUMBAI- 400 057.</u>	BEST Plot, Kandarpada, Dahisar (W), Mumbai,
2.	M/s. Shree Constructions, 8/44, Vineet Nagar, Cotton Green, <u>MUMBAI- 400 033.</u>	Tembhode village, New Panvel, Dist. Raigad

Note : The valid list at the time of execution of works can be obtained from the Dy.Ch.Eng. (Roads) E.S.'s office.

- **LIST OF THE APPROVED MANUFACTURERS FOR SUPPLYING FRP / GRP FRAME & COVERS**

Sr. No.	Name & Address of the manufacturer	Brand Name
1.	M/S Thermo Poly Products (I) Pvt Ltd, Ameza plaza, C-302, 3 rd floor, plot no 52, Sector 15, CBD belapur, New Mumbai – 400614.	Thermodrain
2.	M/S Titan Enterprises, 44, Khanna Construction House, East wing 2 nd floor, above flora Chinese restaurant, AGK road, Worali, MUMBAI-400018.	Everplast
3.	M/S Parshwanath Concrete, Shop No. 5, Shivom Co Op HsgSoc, Opp Greater Bombay Co Op Bank, RatanNagar, Borivali (E), Mumbai.	Parshaw

Note : The validity of the list of approved manufacturers shall be confirmed from Dy.Ch.Eng. (SWD) PC.'s office at the time of execution of works.

- **LIST OF APPROVED BUILDING MATERIALS**

Following brands of building materials have been approved by Ch.E.(B.M.) / Director(E.S.&P.) u/no. Ch.E. / BM / 07591/ II dated 05.07.2022. The brands of the building materials approved and mentioned in the list with the validity given below shall be used. For the materials other than mentioned in the list brands, only ISI marks materials shall be allowed to be used with prior written permission of the engineer, for individual work. The contractors shall distinctly understand that it will not be their prerogative to insist for use of particular make/brand from following list and final selection will have to be done with approval of engineer. The following list of approved building materials may vary and some new category/brand may be added or existing ones may be deleted. The contractor shall use the brand as directed by the engineer

Sr. No	Category	Product	Brand Name if any	Manufacturer's Name & Correspondence address	Contact Details	Validity
1.	Cement	OPC 53 Grade & PPC	"SANGHI"	M/s. Sanghi Cement Limited, Krishna Commercial Centre, 11, B-Wing, 6-Udyog Nagar, S.V. Road, Near Kamath Club, Goregaon (West), Mumbai- 400 062	(022)-28713120 (0261)-2331019	27.07.2023
2.	Cement	OPC 53 Grade PPC	"HATHI"	M/s. Saurashtra Cement Limited, Gala No. A-1, Ground Floor, Udhog Sadan No. 3, MIDC, Central Road, Andheri (East), Mumbai- 400 093	(022)-32955567 / 32955557	24.09.2023
3.	Cement	OPC 43, 53 Grade & PPC	"PERFORMATE, OPTIMATE & DURAMATE"	M/s. Kalburgi Cement Private Limited. 8-2-626, Reliance Majestic, Road No. 10, Banjara Hills, Hyderabad-500034	(022)-40831234	18.03.2024
4.	Cement	OPC 53 Grade & PSC	"PSC & CONCRETE LHD"	M/s. JSW Cement Limited, JSW Centre, Bandra Kurla Complex, Bandra (E), Mumbai-400051	Mob.:- 9820234395	03.03.2024
5.		OPC 53 & PPC	SHREE CEMENT - ROOFON & JUNGROD HAK	M/s. Shree Cement Ltd, One BKC Building, 1110 A, 11TH Floor, C Wing, Plot no. C-66, G Block, Bandra Kurla Complex, Bandra (East), Mumbai- 400 051	Mob.:- 9819623490	22.03.2025
6.	GGBS	Ground Granulated Blast Furnace Slag	JSW	M/s. JSW Cement Limited, JSW Centre, Bandra Kurla Complex, Bandra (E), Mumbai-400051	Mob.:- 9819990801	03.03.2024

7.	White Cement	White Cement, Putty & Others	J K MAXX	M/s. J. K. White Cement Works 4TH Floor, Krsna Chambers, Plot no. 11, Galaxy Garden, North Main Road, Koragaon Park, Pune-411001		22.03.2025
8.	Reinforcement Protection coating	Epoxy Reinforcement Bars	"EPOXY SHIELD"	M/s. Hariom Ingots & Power Pvt. Ltd., Plot 59-60, Light Industrial Area, Bhilai, Chhattisgarh-490 026.	Mob.:- 78840553 00	01.02.2023
9.	Reinforcement Protection coating	Epoxy Reinforcement Bars		M/s. Eurocoustic Products Ltd. FBEC Divn, PSL Campus, Kachigam (Via Vapi-Guj), Daman, (U.T.)-396210	022- 66447777 / 66447787	09.11.2023
10.	Reinforcement Bars	TMT bars of Grade (Fe415, Fe500, Fe500D)	"SURYA TMX"	M/s Surya Ferrous Alloys Private Ltd. 117, 1 ST Floor, Sky Lark Building, Sector No. 11, Plot No. 63, C.B.D. Belapur, Navi Mumbai- 400614	(022)- 27573081 / 7480 / 7420	08.11.2023
11.	Reinforcement Bars	TMT bars of Grade (Fe415, to Fe550D)	"SUN TMX QST" & "MORIYA"	M/s. Jaideep Metallics & Alloys Pvt. Ltd., Gut No. 73, 74, 76, 78, 79, 80, 179, 180, Village Lakhmapur, Bhiwandi Wada Road, Taluka Wada, Thane-421303.	(022)- 42032003 FAX- (022)- 42032020	08.11.2023
12.	Reinforcement Bars	TMT (Fe415 to Fe550D), FBE Coated Bars & CRS (Fe415 to Fe550D)	"ELECTRO TMT PLUS" "ELECTRO CRS GOLD"	M/s. Electrotherm India Ltd., Survey No. 325, NH 8A, Nr. Toll Tax Booth, Samkhiyali, Ta. Bhachhau, Dist. Kutch. Gujrat- India	(022)- 65201597 / (02717)- 660649	08.11.2023
13.	Reinforcement Bars	TMT bars of Grade (Fe415, to Fe 550D)	"GUARDIAN"	M/s. Guardian Castings Pvt. Ltd. 415, Mahinder Chambers, W.T. Patil Marg, Opp. Dukes Factory, Chembur, Mumbai-400071	(022)- 67975145 / 5146	08.11.2023
14.	Reinforcement Bars	TMT bars of Grade (Fe 500, Fe 500D & Fe 550D)	"BHAGWATI"	M/s. Bhagwati Steel Cast Pvt. Ltd., D-101, MIDC, Malegaon, Sinner, Dist-Nashik-422113, Maharashtra	022- 40354444 Fax- 40350432	14.10.2022
15.	Reinforcement Bars	TMT bars of Grade (Fe 500, Fe 500D & Fe 550D)	"REGENCY"	M/s. Regency Ispat Pvt. Ltd., 507, Bharat Chambers, Baroda Street, Iron Market, Carnac Bunder, Mumbai - 400009	(0251)- 2703815/ 98201468 15	29.09.2023
16.	Reinforcement Bars	TMT bars of Grade (415 to Fe 550D)	"THANE"	M/s. Thane Steel Limited, 14, Steel Yard House, S.T. Road, Carnac Bunder, Mumbai - 400009	Mob.:- 83560599 49	22.08.2024
17.	Reinforcement Bars	TMT (Fe415 to Fe550D), FBE Coated bars	"CAPTAIN"	M/s. Captain Steel India Limited, 10A, Shakespeare Court,	(033)- 40112525 / Mob.:-	23.03.2025

		(Fe500 to Fe600) & FBE Coating to TMT bars		21A, Shakespeare Sarani, Kolkata-700017	8873125000	
18.	Reinforcement Bars	Non Corrosive SS Rebar of grade SSR 550	"SUNFLAG"	M/s. Sunflag Iron & Steel Co. Ltd. 33, Mount Road, Sadar, Nagpur - 440001 (India)	Mob.:- 9325360201/ 9323221481	31.10.2024
19.	Reinforcement Bars	TMT bars of Grade Fe (415 to Fe 500D)	"METRO"	M/s. Metro Ispat Pvt. Ltd., Potia Industrial Estate, 3 RD Floor, Darukhana, Reay Road, Mumbai - 400010	Mob.:- 9819681961	03.12.2024
20.	Reinforcement Bars	TMT bars of Grade Fe500, Fe500D, Fe550 & Fe550D	KALIKA	M/s. Kalika Steel Alloys Pvt. Ltd., Office No. 412, Shreekant chambers Premises, Sion Trmobay Road, Chembur, Mumbai - 400071	Mob.:- 9049997311	28.03.2025
21.	Reinforcement Bars	TMT bars of Grade Fe500, Fe500D, Fe550 & Fe550D	"KHATU"	M/s. Shri Khatu Shyam Alloys Pvt. Ltd., Survey no. 148/3, Near Parle Biscuit Company, Village-Kharadpada, Silvasa-396230	Mob.:- 9930772570	16.06.2025
22.	Tiles	Ceramic & Vitrified Tiles (IS 15622:2006)	"DAKSHIN AMURTI"	M/s Akash Ceramic Pvt. Ltd. Complex,3 rd floor, Drive-in cinema road, Ahmedabad-54	(079)- 26857400/500	25.12.2023
23.	Tiles	Ceramic & Vitrified Tiles (IS 15622:2006)	"AMBANI"	M/s. Ambani Vitrified Pvt. Ltd., Survey No.143 P1/P1, Morbi Charadva Road, Unchi Mandal, Morbi, Gujrat-363641.	Mob.:- 9727723151/ 9082121550	06.01.2023
24.	Tiles	Ceramic & Vitrified Tiles (IS 15622:2006)	"VARMORA"	M/s. Varmora Granito Pvt. Ltd., A-54, 1 st Floor, Elite Auto House, Mathuradas VasANJI Road, Andheri-Kurla Road, Andheri (East), Mumbai -	(022)- 28389790/91/92	27.09.2023
25.	Tiles	Ceramic & Vitrified Tiles (IS 15622:2006)	"ORIENT BELL"	M/s. Orient Bell Ltd., Iris House, 16 Business Centre, Nangal Raya, New Delhi- 110046	(011)- 47119100	16.10.2023
26.	Tiles	Ceramic & Vitrified Tiles (IS 15622:2006)	RAK	M/s. RAK Ceramics India Pvt. Ltd., 1ST Floor, Carnival House, Opp. Oberoi Mall, Dindoshi Road, Malad East, Mumbai-400063	Mob.:- 9920027828	22.02.2024
27.	Tiles	Ceramic & Vitrified Tiles IS 15622:2006	CREANZA	M/s. Commander Vitrified Pvt. Ltd., 8-A NH, B/H Landgrace Ceramic, At. Sartanpar, Ta. Wankaner, Morbi, Gujrat-363621	Mob.:- 9320812511	16.02.2024

28.	Tiles	Ceramic & Vitrified Tiles IS 15622:2006	"ZEALTOP"	M/s. Zealtop Granito Pvt. Ltd., Old Ghantu Road, Morbi, Gujrat -363642	(022)- 28728750 /7585	12.06.2024
29.	Tiles	Ceramic & Vitrified Tiles IS 15622:2006	"PRIYAM GRANTILE	M/s. Solvish Ceramic LLP Survey No. 106/2, Matel Road, Nr. Classy sanitaryware, Wankaner, Morbi, (Gujrat)- 363622	Mob.:- 93242325 44/ 98338778 21	25.10.2024
30.	Tiles	Ceramic & Vitrified Tiles IS 15622:2006	"SOMANY"	M/s. Somany Ceramics Limited, 401 to 408, Bonanza building, Sahar Plaza, Next to Kohinoor hotel. Andheri-Kurla Road, Andheri (East), Mumbai- 400 059	Mob.:- 75064086 96 / (022)- 40398300	27.02.2025
31.	Tiles	Ceramic & Vitrified Tiles IS 15622:2006	"AGL"	M/s. Asian Granito India Ltd., 202, Dev arc, Opp. Iskon temple, S. G. Highway, Ahmadabad - 380 015	(079)- 66125500 /698	07.04.2025
32.	Sanitary ware	Water Closet /Basin/Urinal Cistern (IS 2556:2004)	RAK	M/s. RAK Ceramics India Pvt. Ltd., 1ST Floor, Carnival House, Opp. Oberoi Mall, Dindoshi Road, Malad East, Mumbai- 400063	Mob.:- 99200278 28	22.02.2024
33.	Sanitary ware	Water Closet /Basin/Urinal Cistern (IS 2556:2004)	PRIYAM GRANTILE	M/s. Solvish Ceramic LLP Survey No. 106/2, Matel Road, Nr. Classy sanitaryware, Wankaner, Morbi, (Gujrat)- 363622	Mob.:- 93242325 44/ 98338778 21	25.10.2024
34.	Cast Iron Pipes & Fittings	CI Pipes (IS 3989:2009)	"NFL"	M/s. Nagpur Foundries Limited, N-72, MIDC, Hingana Road, Nagpur - 440 016.	(0712)- 2768232	06.11.2022
35.	Cast Iron Pipes & Fittings	CI Pipes (IS 3989:2009)	"RPMF"	M/s. Raj Pattern Makers & Founders Pvt. Ltd. Nagla Kishan Lal, Hathras Road, Agra, Uttarpradesh - 282006	Mob.:- 97602832 96	20.03.2025
36.	RCC pipes	NP3 & NP4 class (450 mm - 1800 mm)	"ACPPL"	M/s Aadit Concrete Products Pvt. Ltd. 80/85, Om Laxmi Niwas, Prabhat Main Road, Near Royalty Hotel, Erandwane, Pune-411004.	Mob.- 95525 29191	14.03.2024
37.	RCC pipes	NP2 (150mm - 600mm) NP3 (150mm - 1200mm)	"SHIVAMM "	M/s. Shivamm Industries, Arihant heights, Plot 76, Sec- 25, Near Gyan Prabhodhini School, Pradhikaran, Nigadi, Pune - 411044	(020)- 27651888	13.08.2022
38.	RCC pipes	NP3 & NP4 class (400 mm - 1800 mm)	"POONA CONCRET E"	M/s. The Poona Concrete Products Co. 996, Navi Peth, Abhinav Apartment, Pune-411030	Mob.:- 99201774 56	14.04.2024
39.	RCC pipes	1) NP2 class (150 mm -	"PRANALI"	M/s Pranali Cement Pipes Pvt. Ltd,	Mob.:- 93246226	15.03.2024

		300 mm) 2) NP3 & NP4 class (150 mm -1800 mm)		311,Kesar Krupa CHS Ltd., Above Saraswat Bank Ltd., Chandavarkar Road, Borivali(w), Mumbai-400092	69	
40.	RCC pipes	1) NP2 class (100 mm - 600 mm) 2) NP3 & NP4 class (150 mm -1200 mm)	"SAGAR SPUN PIPE"	M/s. Sagar Spun Pipes, Plot No. C-9, MIDC Industrial area, Waluj, Aurangabad – 431136	Mob.:- 9822233999	04.06.2024
41.	Single Stack System	HDPE Single stack system	"GEBERIT"	Geberit Plumbing Technology India Pvt. Ltd. 305, B-Wing, Dynatsy Bussiness park, Andheri Kurla Road, Andheri (E) Mumbai 400059.	(080) – 23376127 /23570612	21.08.2022
42.	PP Pipes & Fittings	"Multi-Layer Polypropylene Silent Pipes & Fittings"	"HULIOT"	M/s Huliote Pipes & Fittings Private Limited. 401, Siddharth Complex, R.C. Dutt Road, Alkapuri, Vadodara, Gujrat-390 007	Mob.:- 9099936326	26.07.2022
43.	CPVC SWR, uPVC & PVC Pipes	(i) CPVC pipes IS 15778 and CPVC fitting IS7834 (ii) UPVC SWR Pipes IS 13592:1992 & Fittings 14735:1999 (iii) Potables water supply Pipes IS 4985:2000 (iv) uPVC pipes	"TRUFLO BY HINDWAR E"	M/s. HSIL Limited, Unit 501 & 504, Block-A, "The Platina", Survey No. 136, Gachibowli-Miyapur Road, Gachibowli, Hyderabad, Telangana- 500032	(040)-66288000 Mob.:-9898348983	26.03.2025
44.	SWR	UPVC SWR Pipes IS 13592:1992 & Fittings 14735:1999	BIRLA AEROCON	M/s. HIL Limited, L7 Floor, SLN Terminus, Sy. No. 133, Beside Botanical Garden, Gachibowli, Hyderabad- 500 032, Telangana.	Mob.:- 8600004036	29.03.2024
45.	PPR Pipes & Fittings	PPR Pipes & Fittings (IS 15801:2008 for Hot & Cold water supply)	"KPT GREEN THERM"	M/s. Kanha Plastics Pvt. Ltd., Unit no. 306, PP Trade Center, Plot no. P-1, Netaji Subhash Place, New Delhi-110035	Mob.:- 9634007985/ 96349044722	16.08.2023
46.	DWC	DWC Pipes & Fittings (IS 16098:2016)	D-REX	M/s. Astral Poly Technik Limited 207/1, Astral House, B/h Rajpath Club, Off. S. G. Highway, Ahmedabad-380059	Mob.:- 8108783849	29.02.2024
47.	SWR, UPVC, CPVC, &	i) SWR Pipes IS 13592:1992 ii)UPVC injection moldings	"ULTRAFIT" "FLOWGUARD"	M/s. Prince pipes & Fittings Pvt. Ltd, The Ruby, 8 th floor, 29, Senapati Bapat Marg, (Tulsi pipe road), Dadar (W),	(022)-66022222 Fax-(022)-6602 2220	04.04.2025

	Foam core Pipes	fittings IS14735:1999 iii)CPVC pipes IS 15778 and CPVC fitting IS7834 iv) UPVC Pipes IS4985:2000 v) Foam core pipes IS16098: 2003 vi) upvc Pipe for potable water	PLUS" "AQUAFIT" "FOAMFIT"	Mumbai- 400 028		
48.	Polypropylene Pipes	PPR Pipes	GREENFIT	M/s. Prince pipes & Fittings Pvt. Ltd, The Ruby, 8 th floor, 29, Senapati Bapat Marg, (Tulsi pipe road), Dadar (W), Mumbai- 400 028	(022)- 66022222 Fax-(022)- 6602 2220	04.04.2025
49.	High Density Polyethylene Pipes	DWC Pipes	CORFIT	M/s. Prince pipes & Fittings Pvt. Ltd, The Ruby, 8 th floor, 29, Senapati Bapat Marg, (Tulsi pipe road), Dadar (W), Mumbai- 400 028	(022)- 66022222 Fax-(022)- 6602 2220	04.04.2025
50.	Polyethylene tank	Water Storage Tank	STOREFIT	M/s. Prince pipes & Fittings Pvt. Ltd, The Ruby, 8 th floor, 29, Senapati Bapat Marg, (Tulsi pipe road), Dadar (W), Mumbai- 400 028	(022)- 66022222 Fax-(022)- 6602 2220	04.04.2025
51.	Chemicals	Construction Chemicals	"SUNANDA"	M/s. Sunanda Speciality Coatings Pvt. Ltd, Satyadham Road no. 2, Sion (E), Mumbai – 400 022	(022)- 24034130	17.12.2023
52.	Chemicals	Construction Chemicals	"CICO"	M/s. Cico Technologies Ltd., AC-10-B/11, Raj Laxmi Commercial Complex, Kalher-Bhiwandi Road, Thane- 421302	(022)- 27811913	23.07.2022
53.	Chemicals	Construction Chemicals	"Dr. Fixit" & "ROFF"	M/s. Pidilite Industries Limited, Marketing Division, Ramkrishna Mandir Road, Andheri (E), Mumbai- 400059	Mob.:- 84518024 82/ 88284271 30	13.08.2022
54.	Chemicals	Construction Chemicals	"ASWANI"	M/s. Aswani Industries Private Limited, 2ND Floor, Office-25, TPS-4, FP-172, Ascon City, City Light Road, Surat, Gujrat – 395007	Mob.:- 98795069 18	22.10.2022
55.	Chemicals	Construction Chemicals	"ASIAN PAINT SMARTCARE"	M/s. Asian Paints Limited, Asian Paints House, 6A, Shanti Nagar Santacruz (E), Mumbai- 400055	(022)- 62181000	03.11.2022
56.	Chemicals	Construction	"CHRYSO"	M/s. CHRYSO India Private	Mob.:-	16.08.2023

		Chemicals		Limited Plot No. D-30/7, TTC Industrial Area, MIDC Turbhe, Navi Mumbai- 400705	95949488 58	
57.	Chemicals	Construction Chemicals	"HIND"	M/s. Hindcon Chemicals Limited 62B, Braunfeld Row, Vashudha, Kolkata- 700027	(033)- 24490835 /39	02.01.2023
58.	Chemicals	Construction Chemicals	"KRYTON"	M/s. Kryton Buildmat Co. Pvt. Ltd. 136-137, Centrum Plaza, Golf Course Road, Sector 53, Gurugram, Haryana-122002		10.11.2023
59.	Chemicals	Construction Chemicals	"SHREE PRIMIX"	M/s. Shree Premix Industries, 104, Corporate Avenue, Near Udyog Bhavan, Sonawala Lane, Goregaon (East), Mumbai- 400063	(022)- 26853022 / 98215418 67/ 70459509 21	11.11.2023
60.	Chemicals	Construction Chemicals	"PERMA"	M/s Perma Construction Aids Pvt. Ltd. 611/612 Nirmal Corporate Centre, Mulund (W) Mumbai-400080	(022)- 25903008	25.12.2023
61.	Chemicals	Construction Chemicals	"BOXER"	M/s. Boxer Construction Chemicals, Sudhashil, B-31, Kalidas Colony, Satara Road, Tal- Koregaon, Satara- 400 072	Mob.:- 98509686 26	21.06.2023
62.	Chemicals	Construction Chemicals	"FAIRMAT E	M/s. Fair Mate Chemicals Pvt. Ltd. 8/1, Sai Sudha, Arunoday Soc. Alkapuri, Vadodara (Gujrat)- 390007	(0265)- 2358173/ 2331193	22.03.2024
63.	Chemicals	Construction Chemicals	"PAR"	M/s. Par Specialty Polymers Pvt. Ltd. Unit No-309, Turbhe Industrial Park, Plot no. C- 56/1, TTC Industrial Area, Turbhe, Navi Mumbai- 400705	Mob.:- 96195155 66	18.05.2024
64.	Chemicals	Construction Chemicals		M/s. Tiki Tar Danosa India Pvt. Ltd. Tiki tar state, Village Road, Bhandup (W) Mumbai- 078	(022)- 41266699	06.06.2024
65.	Chemicals	Construction Chemicals		M/s. Rheoplast Technology Pvt. Ltd., 711, A Wing, Mainframe-1, Royal Palm, 169 Aarey Colony. Goregaon (E), Mumbai-400065	Mob.:- 80804440 30	10.10.2024
66.	Chemicals	Construction Chemicals		M/s. Fosroc Chemicals (India) Pvt. Ltd., Embassy Point, No. 150, 2ND Floor,	Mob.:- 84339734 13	27.02.2025

				Infantry Road, Bengaluru - 560001		
67.	Chemicals	Construction Chemicals		M/s Krishna Conchem Product Ltd. Unit-2,Bldg.6,Sect.3, Millennium Business Park, Mahape, Navi Mumbai-400710	(022)- 32986329 / 27782923 / 09324924 398	21.09.2024
68.	AAC Block	AAC Block	BIRLA AEROCON	M/s. HIL Limited, L7 Floor, SLN Terminus, Sy. No. 133, Beside Botanical Garden, Gachibowli, Hyderabad- 500 032, Telangana	Mob.:- 86000040 36	29.03.2024
69.	AAC Block	AAC Block	MAGICRETE	M/s. Magicrete Building Solutions Pvt. Ltd. 702, 22 Business Point, S. V. Road, Andheri (West), Mumbai-400058	Mob.:- 99704652 15	22.06.2024
70.	Ready to use Mortar	Ready Mix Mortar & Block Jointing Mortar	MAGICRETE	M/s. Magicrete Building Solutions Pvt. Ltd. 702, 22 Business Point, S. V. Road, Andheri (West), Mumbai-400058	Mob.:- 99704652 15	22.06.2024
71.	Ready to use Mortar	Ready Mix Mortar & Block Jointing Mortar	"SILICOPLAST & SILICOFLEX"	M/s. Precise Conchem Pvt. Ltd., 202, The Great Eastern Chambers Premises, Plot-28, Sector-11, CBD Belapur - 400 614	(022)- 27562962 / +91- 93200586 35	26.03.2023
72.	Ready to use Mortar	Ready Mix Mortar & Block Jointing Mortar	"KANERIA"	M/s. Kaneria Plast Pvt. Ltd. 6TH Floor, Rohan Arcade, Off W.E.Highway, Dattani Park, Thakur Village, Kandivali (E), Mumbai- 400101	Mob.:- 82918924 01/ 82918924 14	25.10.2024
73.	Paints	External and Internal Paints	"PEARL/COLORTE X/ KLASSIC/ UNO/ INSPIRA"	M/s. Godavari paints Pvt. Ltd., Tulsiram Gupta Mills Estate, Darukhana, Reay Road, Mumbai 400010	(022)- 23723227	05.02.2024
74.	Paints	External and Internal Paints	SNOWCEM	M/s. Snowcem Paints Private Limited, 702 A, Pranik Chambers, Saki Vihar Road, Andheri (E), Mumbai - 400072	(022)- 28573551 / 28572700	25.10.2023
75.	Paints	External and Internal Paints		M/s. Advance Paints Pvt. Ltd. Advance House, Plot no. A, Ark Industrial Compound, Makwana Road, Marol Naka, Andheri (E), Mumbai - 400059	(022)- 28590162 /63/64	16.12.2023
76.	Paints	External and Internal Paints	"FAIRCOAT, FAIRTEX, FAIRSHIN"	M/s. Hindusthan Paints and products, 11-A New Empire industrial Estate, Kondivita road Andheri(E), Mumbai	(022)- 28223341	06.05.2024

			E, FAIRLOOK "	400059		
77.	Paints	External Paints	--	M/s. Dooall Corpro India Pvt. Ltd. 315, Bhaveshwar Arcade Annexe, LBS Road, Ghatkopar (West)-400086	Mob.:- 98208744 10	22.08.2024
78.	Paints	External and Internal Paints	--	M/s. Excel India Protective Paints Pvt. Ltd. A-33 & 34, MIDC Kulgaon, Badlapur, Thane-421503	Mob.:- 98922270 39 (0251)- 2695520	20.10.2024
79.	FRP Cover with Frames	Manhole cover with frames and Grating with Frames	"KK"	M/s, K. K. Manhole & Grating Co. Plot. No. A-47 & 119/120/129, STICE, Shirdi Road, Sinner, Nashik. Maharashtra - 422103.	(0253) - 2340556	02.09.2022
80.	SFRC Cover with Frames	Manhole cover with frames and Grating with Frames	"KK"	M/s, K. K. Manhole & Grating Co. Plot. No. A-47 & 119/120/129, STICE, Shirdi Road, Sinner, Nashik. Maharashtra - 422103.	(0253) - 2340556	20.04.2023
81.	SFRC Cover with Frames	Manhole cover with frames and Grating with Frames	"VIKRANT"	M/s. Vikrant Reinforced Products Pipewala Compound, Opp Unionbank, Near Chembur Police station, Chembur, Mumbai- 400074	Mob.:- 98692508 44	06.09.2024
82.	FRP Cover with Frames	Manhole cover with frames and Grating with Frames	"STRONG DRAIN"	M/s HP Adhesives Private Limited. 11, Unique House, Chakala, Andheri (East), Mumbai - 400099	Mob.:- 98672549 25	13.08.2022
83.	Ductile iron Covers with Frames	DI Manhole covers with Frame and Gratings	"PLASMA"	M/s Plasma Alloys Pvt. Ltd. Survey No.196,N.H.27,Gondal Road Veraval (Shapar) Dist-Rajkot- 360 024 Gujrat	(02827)- 253766 Fax- (02827)- 253966	29.11.2024
84.	Ductile iron Covers with Frames	DI Manhole covers & Frame and Gratings	"GOLDSTA R"	M/s. Gold Star Steels (P) Ltd. 53/A, Industrial Area, Bhanpuri, P.O. Birgaon, Raipur-493221,Chattisgarh	Mob.:- 98203178 75	23.09.2022
85.	Ductile iron & Cast iron Covers with Frames	DI & CI Manhole covers with Frame and Gratings	"RBA"	M/s. RBA Exports Private Limited, 2/6, Sarat Bose Road, Central Plaza, Suit No. 606, 6 th Floor, Kolkata-700020	Mob.:- 98339925 57	12.12.2022
86.	Ductile iron Covers with Frames	DI Manhole covers with Frame and Gratings	"NEXUS"	M/s. Nexus Cast S. R. No. 128, Plot 1, Gaurav Industrial area, Opp. 132 KV Substation, Nr. Sardar Chowk, Rajkot - 360024	Mob.:- 70211409 73	01.11.2024
87.	Ductile iron & Cast iron Covers with Frames	DI & CI Manhole covers with Frame and Gratings	"RPMF"	M/s. Raj Pattern Makers & Founders Pvt. Ltd. Nagla Kishan Lal, Hathras Road, Agra, Uttarpradesh - 282006	Mob.:- 97602832 96	20.03.2025

88.	Door Shutter & Frame	FRP Door Shutter & Frame	"SANCOM"	M/s. Sancom Composites LLP Gala No. 123, Blue Rose Industrial Estate, W.E. Highway, Borivali (E), Mumbai - 400066	Mob.:- 93236574 15	17.03.2023
89.	Door Shutter & Frame	FRP Door Shutter & Frame	"PERMAFINISH"	M/s. Advance FRP, 4, Avinash Bhuvan, Next to Gujarati School, Kankuwadi Dixit Cross Road no. 1, Vile Parle (E), Mumbai- 400057	(022)- 26175636 / 26122376	07.10.2024
90.	Door Shutter & Frame, Plywood, Block Board,	Flush, Panel, Fire retardant Wooden Doors, Plywood, Block board, Laminates, Veneer	"KALPTAR U"	M/s. V. K. Patel & Co., G 2, 3, & 4, Mahesh Darshan, Near Makhmali Talao, old Agra Road, Thane (West) - 400601	82919731 09/ (022) 25431548 / 96199359 55	13.05.2024
91.	Door Shutter & Frame, Plywood, Block Board,	Flush wooden Doors, Plywood, Block board,	"REGENCY"	M/s Regal Plywood Industries (P) Ltd. C/o, M/s. Regency Wood Panel Pvt. Ltd. 106, 1st Floor, Palm Beach Galleria, Plot no. 17, Sec-19D, Vashi, Navi Mumbai-400703.	Mob.:- 98208111 75/ 96193611 49	27.02.2025
92.	Railing	Aluminum Railing	ENDURAIL	M/s. Chemey Techsolutions LLP, 202-Campus Corner, Nr. St. Xavier's Collage Corner, Navrangpura, Ahmedabad-380009	Mob.:- 99252055 52	15.08.2022
93.	Fire Door & Non Fire Door	Fire Door & Non Fire Door	"HORMANN"	M/s. Shakti Hormann Pvt. Ltd. H. No. 2-67/1, (Survey No. 188, 198). Gagillapur, Dundigal Municipality, Mandal, Dist-Medchal (Malkajgiri), Telangana-500043	+(40)- 27840394 /5	30.09.2024
94.	Geosynthetic Fibre	Non Woven Geo Textile, Geo Grid, Membrane, Mats, Nets	"JEEVAN"	M/s. Jeevan Products, Kailas Business Park, Kailas Complex, Powai Vikhroli Link road, Veer Sawarkar Marg, Park Site, Vikhroli (West), Mumbai - 400 079	Mob.:- 70459093 72	02.01.2023
95.	Carbon Fibre & Glass Fibre	Carbon Fiber, Glass Fiber & Carbon Laminate Strips	"URJA"	M/s. Urja Products Pvt. Ltd., Survey No. 53, Inside Pirana Gate, Before Ode Village, Nr Cow Circle on outer Ring Road, Piplej-Pirana, Ahmedabad, Gujrat - 382427	Mob.:- 98215762 79	19.01.2023
96.	Vinyl Flooring	Vinyl	"RESPONSIVE"	M/s. Responsive Industries Limited, Mahagaon Road, Betegaon Village, Boisar (East), Palghar-401501	(022)- 66562727 /2704	19.01.2023

97.	Cladding	Aluminium Composite Cladding (ACP)	"VIVA"	M/s. Viva Composite Panel (P) Ltd. Unit No. 7, New Tejpal Industrial Area, Andheri Kurla Road, Sakinaka, Andhri (E), Mumbai-400072	(022)-28500150 /151/152	16.02.2023
98.	Cladding	Aluminium Composite Cladding (ACP)	"ALUDECOR"	M/s. Aludecor Lamination Pvt. Ltd., Suit no. 52, 5TH floor, R.N. Mukherjee Road, Kolkata-700001, West Bengal	(022)-26866633 / 986757305	16.08.2023
99.	Cladding	Aluminium Composite Cladding (ACP)	"EUROBOND"	M/s. Euro Panel Products Pvt. Ltd., 702, Aravali Business Centre, Ramdas Sutrale Road, Borivali (West), Mumbai-400092	(022)-29686500	11.11.2023
100.	Cladding	Aluminium Composite Cladding (ACP)	"SUPERBOND"	M/s. Keybond Industries LLP, 17, Super House, Amar Brass Ind. Estate, CST Road, Santacruz (East), Mumbai-400092	(022)-66758380 /8359	27.07.2024
101.	Precast RCC products	Precast RCC Drain, Box Culverts & Retaining wall	"FUJI"	M/s Fuji Silvertch Concrete Pvt. Ltd. 4TH Floor, House no. 5, Magnet Corporate Park, Nr. Sola Flyover, SG Road, Thaltej, Ahmedabad- 380054, Gujrat.	(079)-40210000 / 9833711834	01.11.2023
102.	Precast RCC products	Manhole Covers, Precast RCC Drain	"SUPER"	M/S Super Cement Article Plot. No. B-49, Behind Union Bank, NICE Area, Satpur MIDC, Nashik-422007	Mob.:- 9869032374 / 9869085007	27.05.2024
103.	Glass	Float, Mirror,	GOLD PLUS	M/s. Gold Plus Glass Industry Limited, 4TH Floo, Kings Mall, Sector-10, Rohoni, New Delhi-110085	Mob.:- 9730041833	04.04.2025
104.	Others	Gypsum plaster/bond/ Wall putty/ False ceiling/Partitions sections	WIP	M/s. Western Infrabuild Products LLP A-592, TTC Industrial Area, MIDC Mahape, Navi Mumbai-400701	Mob.:- 7498196768	23.03.2025

Annexure –G

Rates of testing fees and quantity of samples for tests as approved

PROPOSED RATES OF TESTING FEES AND QUANTITY OF SAMPLES FOR TESTS (YEAR 2022-23)				
Sr. No.	Description of test	Reference/ Standard	Rates in Rs. Per test	Quantity of samples required
A AGGREGATE (COARSE & FINE)				
1	Sieve Analysis (dry)/Fineness Modulus	IS 2386 : Part I – 1963 (Reaffirmed 2021), IS 383 – 1970 (Reaffirmed 2016), MoRTH – 2013	1200.00	20 kg.
2	Silt Content		1510.00	2 kg.
3	Specific Gravity	IS 2386 : Part III – 1963 (Reaffirmed 2021)	1120.00	1 kg.
4	Impact Test	IS 2386 : Part IV –1963 (Reaffirmed 2021), MoRTH – 2013	1510.00	10 kg.
5	Crushing Value/ 10% Fine Value		1780.00	10 kg.
6	Los Angeles abrasion Value		2620.00	10 kg.
7	Water absorption	IS 2386 : Part III –1963 (Reaffirmed 2021), MoRTH – 2013	1120.00	1 kg.
8	Flakiness Index	IS 2386 : Part I –1963 (Reaffirmed 2021), MoRTH –2013	1200.00	10 kg.
9	Elongation Index		1200.00	10 kg.
10	Combined Flakiness & Elongation Index		2340.00	20 kg.
B ASPHALTS				
11	a) Asphalt Macadam / Bituminous Macadam, Asphalt Mixes(Extraction & gradation)	IRC 27 – 2009, MoRTH – 2013	2270.00	7 kg. See Note-2 & 3
	b) Seal Coat (Extraction & Gradation)	Specification MoRTH –2013	2270.00	3 kg. See Note-2 & 3
12	Binder Course (Extraction, Gradation, Density, Voids)	Specification MoRTH –2013	3210.00	7 kg. See Note-2 & 3
13	Asphalt Concrete /Bituminous Concrete/ Dense Bituminous Macadam, Semi Dense Bituminous Concrete/ Polymer Modified Binder(PMB)/ Crumb Rubber Modified Binder (CRMB) (Extraction, Gradation, Density, Voids, Flow value, Marshall Stability)	IRC 29-1988, MoRTH – 2013, IRC-SP-53-2010	4650.00	7 kg. See Note-2 & 3

14	Mastic asphalt (Extraction, Gradation, hardness no)	IS 5317-2002 (Reaffirmed 2017) IS 1195-2002 (Reaffirmed 2017)	2900.00	2 specimen each of 10 cm dia or 10 cm square (2.5cm thk .)
15	Field density of Asphalt mixes /Soils	IS 2720 : Part 28, 1974 (Reaffirmed 2020)	3210 for first test and Rs.1670.00 for each addl. test.	See Note 13 & 23
16	Specific gravity of bitumen	IS 1201 to IS 1220:1978 (Reaffirmed 2019)	1510.00	2kg. See Note-9,10,11
17	Penetration test of bitumen		1510.00	2kg. See Note-9,10,11
18	Softening point of bitumen		1860.00	2kg. See Note-9,10,11
19	Presence of anti stripping agent	CRR I Specifications	1380.00	1 kg bitumen from Plant (sealed)
20	Effectiveness of anti stripping agent		2270.00	1 kg. in wide mouth bottle.
21	Ductility test of bitumen	IS 1201 to IS 1220:1978 (Reaffirmed 2019)	2060.00	1 kg. in wide mouth bottle.
22	Flash Point & Fire point		1380.00	1 kg. in wide mouth bottle.
23	Loss on heating, Thin Film Oven Test		2270.00	1 kg. in wide mouth bottle.
24	Viscosity Test		2480.00	2 kg. See Note-9
C	SOILS			
25	Specific gravity	IS 2720 : Part 3-1980 (Reaffirmed 2021)	1380.00	1 kg.
26	Bulk density		880.00	2 kg.
27	Natural moisture content	IS 2720 : Part 2-1973 (Reaffirmed 2020)	700.00	2 kg. See Note-10
28	Liquid limit	IS 2720 : Part V-1985 (Reaffirmed 2020)	1200.00	10 kg.
29	Plastic limit		1200.00	10 kg.
30	Void ratio (density & specific gravity)		970.00	

31	Standard Proctor Test	IS 2720 : Part 7-1980 (Reaffirmed 2021)	3210.00	20 kg.
32	Modified Proctor Test	IS 2720 : Part 8-1980 (Reaffirmed 2020)	3210.00	20 kg.
33	Laboratory C.B.R. Test	IS 2720 : Part 16-1987 (Reaffirmed 2021)	3950.00	25 kg.
34	Dry Sieve Analysis	IS 2720 : Part 4-1985 (Reaffirmed 2020)	970.00	25 kg.
35	Field C.B.R. Test	IS 2720 : Part 31-1990 (Reaffirmed 2020)	Rs. 3210.00 for first test and Rs.1670.00 for each addl. test.	
36	Safe Bearing Capacity of Soil	IS 6403-1981 (Reaffirmed 2021)	Rs. 3210.00 for first test and Rs.1670.00 for each addl. test	
D	BUILDING MATERIALS			
	CEMENT			
37	Cement (Initial & Final Setting time, Compressive Strength)	IS 269 – 2015 (Reaffirmed 2020) IS 12330 – 1988 (Reaffirmed 2019) IS 455 – 2015 (Reaffirmed 2020) IS 1489 – 2015 (Reaffirmed 2020) IS 4031 – 1988 (Reaffirmed 2019) IS 4031 - 1988 (Reaffirmed 2019)	4050.00	7 kg. See Note-7.
38	Lime		750.00	3 kg
	BRICKS			
39	a) Bricks(Set of Ten) (Compression Test, Absorption Test)	IS 12894-2002 (Reaffirmed 2017) IS 1077-1992 (Reaffirmed 2016) IS 13757-1993 (Reaffirmed 2016) IS 3495 (Part-1) 2019 IS 3495 (Part-2) 2019	2900.00	10 Nos.

	STEEL			
40	Steel bars (6mm dia to 20mm dia)(Area on weight basis, Yield Stress/0.02% Proof Stress , Ultimate Tensile Strength, % Elongation)	IS 432-1982 (Reaffirmed 2020) IS 1786-2008 (Reaffirmed 2018)	3010.00	60 cm. see Note 1 (c), 8.
41	Steel bars (Above 20mm dia)(Area on weight basis, Yield Stress/0.02% Proof Stress , Ultimate Tensile Strength, % Elongation)	IS 432-1982 (Reaffirmed 2020) IS 1786-2008 (Reaffirmed 2018)	3590.00	60 cm. see Note 1 (c), 8.
	CONCRETE			
42	Concrete Cube (Compressive Strength)	IS 456-2000 (Reaffirmed 2021), IS 516-1959 (Reaffirmed 2018)	1380.00	3 Nos. see Note 1 (c), (e), (h) & 18
43	Concrete Beam (Flexure Test) (10x10x50cm)		1780.00	3 Nos. see Note 1 (c), (e), (h) & 18
44	Concrete Beam (Flexure Test) (15x15x70cm)		1780.00	3 Nos. see Note 1 (c), (e), (h) & 18
	TILES			
45	Tiles (Absorption test)	IS 1237-2012 (Reaffirmed 2017), IS 13801-2013 (Reaffirmed 2018), IS 13630(Part-2)-2019, IS 15622-2017 IS 13630 (Part-6)-2019	1670.00	6 Nos. for each test
46	Tiles (Wet Transverse Strength Test)		1670.00	6 Nos. for each test
47	Tiles (Abrasion Test)	IS 13630(Part-12)-2019	3210.00	See Note 15
48	Wood (Moisture content)	IS 287-1993 (Reaffirmed 2017) IS 11215-1991 (Reaffirmed 2020)	1380.00	See Note 14
	CORES			
49	C.C.Road Core (Compression Test)	IS 456-2000 (Reaffirmed 2021), IS 516-1959 (Reaffirmed 2018)	6360.00 per core	See Note 1 (c), (h) & 18
	R.C.C. COVERS			
50	R.C.C. Cover & Dhapa testing	IS 12592 : 2002 (Reaffirmed 2018)	1380.00	

R.C.C. PIPES				
Pipe testing				
51	a) Up to 600 mm dia.	IS 3597-1998 (Reaffirmed 2018), IS 458-2003 (Reaffirmed 2021),	5650.00 Per pipe	Minimum One pipe of Each dia. Per Lot.
	b) 600 to 900 mm dia		6360.00 Per pipe	
	c) 900 mm & above.		7220.00 Per pipe	
CONCRETE PAVING BLOCKS				
Paver Blocks (As per Road Dept. requirement)				
52	a) Water absorption test	IS-15658-2021	1510.00	3 Nos
	b) Compressive test		2900.00	8 Nos
	c) Tensile Splitting test		2900.00	8 Nos
	d) Abrasion Test (Dry Condition)		2900.00	(See note no.21)
53 SWD/MANHOLE FRAME & COVERS (FRP COVERS)				
	a) Light / Medium Duty (Failure Load Test)	IS 1726: 1991, (Reaffirmed 2017) BS EN-124 2015	2640.00	1 no per lot of 50 covers
	b) Heavy Duty (Failure Load Test)		3950.00	
54	C.I Frame & Covers			
	a) Light / Medium Duty (Failure Load Test)	IS 1726: 1991, (Reaffirmed 2017)	2640.00	1 no per lot of 50 covers
	b) Heavy Duty (Failure Load)		3950.00	
55	WATER TABLE (Failure Load Test)	BS-7263: Part 1: 2001 BS EN-1339: 2003	2640.00	1 Sample for 1000 nos of product
56	KERB STONE (Failure Load Test)		2640.00	
57	Welding Test (Tensile)	IS 3600 : 2019	1980.00	(See note no.22)
OTHER CHARGES				
58	Duplicate additional copy of test report not older than 5 years		81.00 Per Copy	

Note: The aforesaid Testing charges are as per Circular issued by Ch.E (Vig) U/no.Ch.E(V)/3344 /B dtd 28/03/2022. The notes mentioned are as per circular. The rates may vary as per circular issued in this regard by Ch.E(Vig) of B.M.C. from time to time

SECTION -15
SPECIAL DIRECTIONS TO
TENDERER

SPECIAL CONDITIONS OF CONTRACT

1. The Tenderer(s) shall note that this contract envisages following works in general -
The Tenderer / Contractor shall note that this contract envisages following works in general:-
 - a) Construction of RCC box drain.
 - b) Reinstatement of approach road abutting to box drain.
 - c) Construction of RCC drain with slab in place of UCR road side drain.
 - d) Repair of Collapsed wall / Improvement of minor / major nalla etc.
 - e) Desilting for the portion of scope of the work. Newly constructed storm water drain maintain and keep clean by desilting and transporting material upto the contract period for which payment will not paid by BMC.
 - f) Any unforeseen work if arises related to catchment area (ongoing work) is to be attended by appointed contractual agency.
 - g) Contractor has to make arrangements for own dumping plot.
 - h) Construction of Footpath as per BMC policy/circular if any.
 - i) Nalla walls to be constructed in CC/RCC.
 - j) Thermo chemically bars to be used in RCC works.
 - k) Use of RMC for all concrete works. RMC allowed only from the plant registered with BMC.
 - l) Construction of parapet wall will be executed as per the approval of competent authority.
2. The representative of the Engineer for this work will be from the offices of Dy. Chief Engineer (SWD) ES.
3. Detailed plans will be available for inspection in the office of Deputy Chief Engineer (SWD).
4. The Tenderer(s) should simultaneously work at number of places or more and complete the work within contract period.
5. The contract period is including period required for mobilization, procurement of material, traffic permission, NOC from Land owning authorities for works, also other required permission viz. erection of site office etc. and shall be reckoned from the date of issue of work order.
6. The contractors will have to obtain permission from the land owner/Land owning authorities etc, well in advance before commencement of work through their premises for execution of the work by displaying appropriate boards. The work may be required to be executed in phases as per respective authority permission. The contractors should therefore take this factor into account while quoting.
7. Programme of work: If at any stage the previously approved programme is required to be modified the contractors shall do so immediately as directed by the Engineer. If it is

necessary to close some phase of the work and start a new phase as directed the tenderer(s) do so without claiming any extra payment. The programme shall be reviewed periodically and rescheduled as directed.

- 8.** All material required for the work can be stacked near the site of work in such manner so as not to cause any inconvenience to the pedestrian and vehicular traffic. If no space is available on site then tenderer(s) shall make his own arrangement for stacking of material etc. No extra payment will be made on this account.
- 9.** The Tenderer(s) shall maintain smooth flow of storm water in nalla/ S.W.D throughout contract period by way of desilting as directed by Engineer-in-charge for which no extra payment will be made.
- 10.** No extra payment shall be admissible for dewatering the trenches, carrying the material by head load transport or approaches to the work site.
- 11.** The contractors will have to obtain water connection for drinking purposes as per conditions in G.C.C. Extra water required for construction purposes will have to be brought by the contractors at his own cost and no extra claims on this behalf will be entertained.
- 12.** The Tenderer(s)/ Tenderer(s) shall note that first class quality of material & workmanship is expected.
- 13.** Quantities of all items provided in the B.O.Q. may not be required to be executed depending upon the site conditions. The tenderer(s) shall not be entitled for any compensation on this account. Before starting the work Tenderer(s) shall consult with the Site Engineer and shall take actual measurements on the site for procurement of material.
- 14.** The Tenderer(s) shall procure all material required for the work from manufacturers with (ISI) certificates and according to B.M.C. specifications wherever applicable. Tenderer(s) shall submit manufacture's test certificate accordingly.
- 15.** The contractors will have to work during nighttime also if required, no extra claims in this regard will be entertained.
- 16.** For minor details of R.C.C. work and whenever any modification is desired same have to be done according to the R.C.C. code of the B.M.C./ I.S. code and as directed by the Engineer-in-Charge.
- 17.** Tenderer(s) should note that the measurements for the excavation items will not be taken for whole quantity of the excavation from the ground level up to the depth specified but will be taken for the quantity excavated between the specified depths only.
- 18.** The successful tenderer(s) will have to make his own arrangement at his cost for the Electric power supply required for the work either by taking connection from Reliance energy Ltd./ M.S.E.B. / B.E.S.T. / TATA or arrange his own generators.

- 19.** Tenderer(s) shall have to obtain all the permissions of the concerned authorities outside the B.M.C. required for carrying out the work. Only recommendatory letters will be issued by B.M.C.
- a) If required, the contractor shall appoint liaison officer for pursuing matters with the Collector, MMRDA, MCZMA, MRDPA, concerned Dy. Collector (Encroachment), concerned Municipal authorities, City Survey office, Reliance Energy, Tata power, Traffic Police or any other concerned offices for expediting encroachment / hurdles removal work from the alignment of Nalla system.
- b) Tenderer(s) shall have to obtain all the relevant permissions/ NOC from MCZMA, or any environmental and forest authority if the construction site falls under coastal Regulation zone or affected due to CRZ, the tenderer(s) has to get it done by approaching / liaison officer for pursuing the same .Only recommendation letters will be issued by the Corporation. The construction work affected due to CRZ will be allowed to be continued subject to clearance of environmental point of view.
- 20.** If due to small quantity of concrete (Less than 10 Cu.m.) or if concrete is not to be used as structural concrete nominal mix of equivalent strength may be made on site by the permission of Engineer, not below the Executive Engineer. However, rebate of Rs. 100/- per Cu. M. shall be taken for non-using the mix design.
- 21.** Contract Labour (Regulation and Abolition act 1970): The Tenderer(s) should specifically note that the successful tenderer(s) shall have to strictly comply with the entire statutory requirement under the provision of the Contract Labour (Regulation and Abolition) Act 1970 and with the Maharashtra State Contract Labour (Regulation and Abolition) Rules 1970 and indemnify the Corporation against any claim(s) whatsoever. Successful Tenderer(s) should obtain Registration Certificate from Labour Commissioner.
- 22.** The Noise level shall be maintained within the permissible limit in silent zone area during construction activities by the Tenderer(s) as per the notification dated 14/01/2000 issued by the Ministry of Environment and Forests.(Condition is included as per circular u/no. C.E/PD/7788/I dated 07/11/2008).
- 23.** List of approved Banks/ Paver block manufacturers/ Asphalt Plants/ R.M.C. Plants etc. have been attached to this document. However, B.M.C. reserves right to modify these lists.
- a) All the asphalt works required to be done under the captioned contract shall be got executed with the specified asphalt mixes manufactured in B.M.C. approved asphalt plants only.
- b) All the Paver blocks/ Kerb stones/ Water tables/ Frame & covers required for the works to be carried out under the captioned contract shall be procured from the specified manufacturers registered with B.M.C. only.
- c) The R.M.C. works required to be done under the captioned contract shall be got executed with the specified R.M.C. mixes supplied by B.M.C. approved R.M.C. plants.
- d) The Mastic Asphalt work will be got done through the specialized agencies having expertise in Mastic Asphalt work.

- 24.** While constructing/improving footpath, provision for slopping ramp of at least 1.00 m width or as directed, shall be made at every carriage entrance, junctions, bus stops etc., for convenience of physically challenged persons.
- 25.** The full time services of the Personnel Team of the Tenderer(s) is mandatory during the entire period of the project.
- 26.** The site shall be cleared by removing all surplus material/silt/earth/debris on or before 31st May of every year.
- 27.** If the Tenderer(s) excavates certain portion of the road and fails to reinstate the same within the stipulated time limit, as per the programme and or before 31st of May, the reinstatement will be got carried out at contractor's risk and cost through other agency in addition to further penal action.
- 28.** All the excavated material belongs to the Brihanmumbai Municipal Corporation (BMC) and therefore shall be the property of Brihanmumbai Municipal Corporation (BMC). It will be mandatory on the part of contractor to use this material in the execution of works under the instant contract or on any other sites of other contracts of B.M.C. as directed by the Engineer; if the quality of material is as per the specification. If any excavated material is used on construction sites then the remainder surplus earth OR if no excavated material is utilized on Municipal works then the entire surplus excavated earth / material including de-silted material shall be removed / transported from sites by the contractor within 24 hours; for which no separate payment will be made. If Municipal dumping grounds are not available for removal of surplus earth then the contractors shall make his own arrangements for removal / transportation / disposal of excavated surplus earth at his own risk and cost. It shall be distinctly noted that B.M.C. will not make any payment towards removal / transportation / disposal of surplus excavated earth including desilted material from construction site to either any Municipal dumping ground (If made available) or to contractor's own dumping facility. The contractors shall take into account the fact while quoting.
- 29.** The Tenderer(s) should note that during the execution of the work, debris etc, dumped on the public streets / places will have to be removed immediately after completion of the work as per direction of the Engineer failing which the same will be got removed at their risk and cost.
- 30.** The work will be treated as completed only after cleaning the site in all respect after completion of the work.
- 31.** Tenderer(s) should maintain the asphalt road stretches after reinstatement in traffic worthy conditions during monsoon free of cost by using asphalt mixes during the course of work.
- 32.** The contractors shall display the boards giving information of name of the work, date of starting completion, Name of the department and contact telephone numbers. Non-compliance of this condition, a penalty of Rs. 1000/- per day per site shall be imposed on contractor.

- 33.** The Tenderer(s) shall take photographs of site as and when directed by Engineer. The Photographs should be so arranged in the Register that original site position and finished site position of the same location should be vis-à-vis. The register should be duly signed by site-in-charge and Tenderer(s) fortnightly. Failure to abide this condition of Rs. 1000/- per photograph copy will be recovered from the contractor`s bill.
- 34.** On Completion of the work, the contractors shall furnish free of cost 2 sets of final completion drawings in AutoCAD along with the soft copy in CD, showing all the details checked and signed by the Engineer within 2 months of completion of works. The payment of final bill shall be made to the contractors after receipt of above sets. In case the contractors fail to submit the completion drawings, the same shall be got done through outside agency and cost of the same shall be recovered from the Tenderer(s) along with the penalty of Rs. 5,000/- per drawing (applicable for only identified works.)
- 35.** All trenches taken in connection with the work should be sufficiently barricaded, as specified. If barricading is not provided a penalty of Rs. 1000/- per meter per day will be imposed upon the contractor as per circular U/No.MGC/F/6342 dated 5.5.2018 and will be deducted from the due Bill.
- 36.** Tenderer(s) should note since the work is to be completed expeditiously. The work should be in progress at several points along the length of the nalla. The Tenderer(s) should put in sufficient resources so as to ensure that the work is completed within the prescribed time period. Time is the essence of the contract. For this purpose, the tenderer(s) may be required to submit a PERT CHART showing the proposed schedule on which basis they intend to execute the work within the prescribed time period. The Tenderer(s) will have to submit BAR CHART, PERT Chart within 15 days from the issue of work order failing which a penalty of Rs. 2000/- per day will be imposed to the contractors.
- 37.** (a) The quantities mentioned in the Bill of Quantities have been worked out by adding the estimated quantities for each individual work mentioned in the tender document.
- (b) Any excess or saving in any item will be considered on total quantities included in the Bill of Quantity of that item in the tender documents.
- (c) Tenderer(s) will have to arrange for unforeseen diversion of utility services during execution at his risk and cost.
- 38.** The contractors should carry out if required any minor works pertaining to S.W.D. works, as may be decided by the Engineer-in-charge anywhere in the ward limit where the work is in progress under contract at the rates included in the Bill of Quantities of the above work with his percentage quoted.
- 39.** The payment for excavation shall be made on cross sectional basis. Before starting the work initial levels will be taken at every 5 m to 2 m or less depending on site conditions along the entire length of the proposed work levels at every 1.50 m to 2m minimum would be taken along the width of the section. The excavation quantity would be computed on the basis of levels thus taken by resorting the Prismoidal Formula or as directed by the Engineer-in-charge in case of encroachment and other structures. For

establishing the datum line the average of the two end points of the ultimate cross-section required for excavation work will be considered.

40. Tenderer(s) should remove cofferdams constructed along/across the nalla before 15th May or as and when directed by engineer to keep the flow of storm water in the nalla unobstructed. No separate payment will be made for this.
41. The contractors are also required to reconstruct the cofferdam if required/directed by the Engineer to complete the balance work.
42. The proposed width for excavation of trenches for various sizes of pipes will be as shown in table at Condition No.6.5.2.
43. R.C.C. pipes to have used on site shall be as per specifications mentioned in the Tender and shall be procured from the Company Registered with B.M.C.

44. BARRICADING:

- It will be entirely responsibility of the contractor to provide and install secure barricades on work sites; **wholly at his risk and cost**. The specification and Drawing of the barricades is attached herewith as annexure – E

Barricading shall be provided free of cost as per Circular vide U/No.MGC/F/6342dated 5.5.2018 and as per Annexure I, II and III of Standard drawings and specifications with slogans and department wise colour codes.

Only two type of barricades having department wise colour coding are proposed to be used depending upon the nature of work i.e. Minor and Major.

i) **Minor works:** Barricading made out of 1.5 mm thick MS plate fixed on M.S. angle post/ frame of 65 mm X 65 mm X 6 mm having height of 1.5 m supported on as shown in Annex-I.

ii) **Major works:** Structural steel barricade made out of 1.50 mm thick M.S. Plate ISMB 250, ISLC 250X50mm and ISA 50mmX50mmX6mm having of size 2.5 m X 2 m as shown in Annex-II.

For **S.W.D.**, Building Maintenance department &for ward works the colour code of the barricading is **Red**.

- The basic principle behind installing secured and continuous barricading is to ensure the safety of vehicular as well as pedestrian traffic and residents in the nearby vicinity of the project. Due to non-installation of appropriate barricades on sites if any mishap occurs leading to injury or loss of life, then the contractor and contractor's Engineer in-charge will be liable for the consequent action.
- Details of the work shall be prominently displayed on the central panel of the barricades along-with the Social Slogans as given in Annexure III and the Cycle of the same shall be maintained.

- The contractor shall provide and install the barricading along with the slogans printed as per the Annexure III, at his own cost and no payment will be made for this; however the contractor shall quote the bid accordingly by considering the cost of barricading.

45. No dumping ground will be made available by B.M.C. for disposal of desilted /excavated /surplus earth material from SWD. The tenderer(s) shall have to make their own arrangement for disposal of desilted / excavated / surplus earth materials. Please note that obtaining N.O.C. from Plot Owner for disposal of desilted / excavated / surplus earth materials on designated private dumping ground and dealing with all the consequences which may arise out of it's utilization shall be the sole responsibility of the tenderer(s). All the necessary charges including payment of Toll fees, Royalty (if any), etc shall have to be borne by the tenderer(s).

Any disputes / litigation regarding removal, transportation and dumping on site shall be sole responsibility of tenderer(s) and B.M.C. shall not be party for that in any case. Tenderer(s) shall indemnify B.M.C. and all its officers regarding any litigation and or issues that may arise out of ownership / NOC / Permission of said dumping site/s as well as removal / transportation / disposal of excavated surplus earth including desilted material. The indemnity bond stating the same shall be submitted in e-Packet B.

46. Circulars u/no. Dy.ChE/4017/SWD/WS dtd. 16.08.2019.

47. U/no. MGC/A/9895 dtd.21.08.2019

Part of tender document.

48. PENALTY CLAUSES :-

48.1 Penalties :

- a) The Engineer not below the rank of Assistant Engineer is entitled to impose a penalty of Rs. 2500/- per day for each defective work/lapse, disobedience of orders of the officer not below the rank of Site Engineer. Penalty amount will be recovered from contractors running bill.
- b) This penalty is over and above Penalty mentioned under G.C.C. clause No. 100.
- c) If it is observed that, the Tenderer(s) carrying out the work fails to comply with the instructions given by the authorities at the A.M.C./M.C.'s level during execution of work twice, the work will be terminated and will be carried out at the risk and cost of the Tenderer(s) and penal action will be taken against them. This decision will not be arbitrable at all.
- d) The abovementioned condition will be in addition to the provision of relevant condition in the General Condition of contract.

48.2 Penalties

- a) The stacked surplus excavated materials shall be removed immediately, failing which a penalty of Rs.5000/- per day per spot will be imposed.

- b) The dumpers carrying the surplus excavated material shall be covered with Tarpaulin sheets during transportation in accordance with MSW 2000 rules and no separate payment shall be made for the same. If the tarpaulin cover is not provided on vehicle or is torn out or small one, a penalty of Rs.**5000/-** per trip for that vehicle will be imposed.
 - c) All the vehicles transporting surplus excavated material, earth, rock etc to dumping ground shall be provided with a board showing "On Municipal Duty". If the board showing that the vehicle is "On Municipal Duty", is not provided a penalty of Rs.**1000/-** will be imposed for per vehicle per trip.
 - d) In the event of any delay on part of the Tenderer(s) to adhere to the contract, B.M.C. shall be entitled, at its option to recover from the Tenderer(s) as agreed, liquidated damages which shall not be by way of a penalty but shall be a genuine pre-estimate of the losses that B.M.C. shall incur, a sum of 0.5% of the price of the total Contract Cost for each work or part thereof, by which the work has been delayed, subject however to a limit of 10% of the Total contract Cost, without prejudice to B.M.C.'s other rights mentioned in the Contract.
 - e) The contractor shall have to take photographs Failure to abide this condition , a Penalty of Rs. 1000/- per photograph copy will be recovered from the contractor's bill
 - f) Tenderer(s) are requested to take cognizance of the child labour act and to take precaution not to deploy child labourers on the work. If child labourers are found deployed on the work, a penalty of Rs. 5,000/- on the spot will be imposed on the defaulting contractor and further action as deemed fit will be taken.
 - g) If the site office with the necessary requirements is not provided within 15 days from the receipt of work order, penalty of Rs.**2000/-** per day will be imposed.
 - h) The contractors shall provide proper safety gears to their staff, labors. Failure to provide safety gears as per above clause a penalty of Rs.**1000/-** per labour per day shall be imposed. The contractor will be fully responsible towards the safety of staff and labor for the entire Contract period.
 - i) During the course of execution of project, if it is noticed that the contractor has not provided barricading then a penalty of Rs.1000/- per meter per day will be imposed upon the contractor as per circular U/No.MGC/F/ 6342 dated 5.5.2018 and will be deducted from the due Bill.
- 49.** If a registered Tenderer(s) (a firm, partnership or company) is deregistered, then any other registered Tenderer(s) (a firm's partnership or company), with any partner or shareholder who is also a partner or shareholder or a "spouse" of such partner or shareholder of the deregistered Tenderer(s) shall also stand automatically deregistered.

- 50.** Demotion shall be restricted to one class immediately below the existing class of registration, Demotion from the lowest class of registration will amount to deregistration.
- 51.** Demotion and deregistration shall apply to all the classes, categories and disciplines under which the Tenderer(s) is registered and will be valid for the remaining period of the contractor's current period of registration or the period specified in the order of demotion, deregistration/ whichever is longer.
- 52.** A deregistered Tenderer(s) shall not be entitled to be issued any tender document / or quotations for any B.M.C. works. Such contractors shall also not be entitled to apply and be considered for renewal of registration or fresh registration at the expiry of period of deregistration. Similarly a demoted Tenderer(s) shall not be entitled to apply and be considered for renewal / fresh registration in a class higher than that to which he was demoted.
- 53.** Temporary huts for the labourer's huts for the S.W.D drains work may be permitted on work site in consultation with the respective Assistant Commissioners and subject to the following conditions or any other condition imposed by the Asstt. Commissioner.
- a) The labourer's hutments will be completely isolated from the public by providing a tin sheet fencing around them.
 - b) They will be specifically identified by B.M.C. staff by numbering them suitably.
 - c) Adequate toilet and bathing facilities will be provided for them inside this fencing.
 - d) The contractors will strictly observe that labourers will use these toilets and bathing facilities and no unhygienic conditions are created at site.
 - e) In case, any of the above conditions is violated such hutments will be removed by the Assistant Commissioner without giving any notice to the Tenderer(s) in consultation with the Executive Engineer in charge of the work.
 - f) The labourers hutments will be removed by the contractors within 7 days or the completion of the work or the last day of the month of May whichever is earlier.
- The Tenderer(s) has to check health of all the labours employed by him at every fortnight and take precautionary measures and treatments as per advice of medical officer. If record is not maintained, penalty of Rs.1000/- per labour will be imposed.
- 54.** Tenderer(s) shall note that no extra payment shall be made for carrying out filling / carrying out preparatory works like excavation, dewatering, compaction, access road, working platform etc. in / adjacent to nalla / river to facilitate implementation of piling works / construction of side walls and the quoted rates of tenderer(s) shall be deemed to include carrying out all temporary works etc. and removal of all temporary works after completion of construction to the entire satisfaction of the Engineer-in-charge or before 15th May, whichever is earlier.
- 55.** If the mangroves are required to be removed during execution of the work under the scope of the tender, the same shall be removed, as per directives of Hon.'ble High Court and as per prevailing Government Directions for which no extra payment shall be paid to the contractor.

- 56.** It is required to prepare drawings/soil investigations/structural drawing and design, of the nalla retaining wall / R.C.C. work as per the site conditions or as directed by Engineer-in-charge. Contractors shall have to appoint licensed Surveyor/Soil investigation consultant/Structural Engineer/ R.C.C. Consultant at his own cost to prepare the drawings/soil investigation reports/structural drawings and designs based on tender items conditions and get the design approval from the department of B.M.C. The expenditure on this account will be deemed to have been considered in the rates quoted by the tenderer(s) and no extra payment shall be paid to the contractor.
- 57.** The tenderer(s) shall carry out subsoil exploration / investigations at the site at his own cost wherever required and as per the directions of Site in-charge. Expenditure on this account will be deemed to have been considered in the rate quoted by the tenderer(s) .
- 58.** Any recommendation / alteration in the work as per decision of Competent Authority of B.M.C. shall have to be executed under the same tender conditions.
- 59.** No claim shall be entertained on account of delay in removal of encroachment.
- 60.** If the alignment of nalla retaining wall is affected by mangroves. The orders in cases pending in various courts in regard shall be binding on the contractors. The tenderer(s) cannot claim any damages / compensation etc. for delay or cancellation of the work or part thereof. This fact shall be kept in mind while quoting for tender.
- 61.** It is observed that Contractors carrying out the work fail to comply with the instructions given by the A.M.C./M.C. during execution of work twice, the work shall be deemed to have been terminated and will be carried out at the risk and cost of the Contractors and penal action will be taken against them. This decision shall not be arbitrable at all.
- 62.** The above condition will be in addition to the relevant conditions in General Conditions of Contract regarding cancellation of full or part of the work, finality of the decisions on the disputes, differences or claims raised by the Contractors relating to any matter arising out of the contract.
- 63.** If concrete surface Finish of work is not as per specified class of finish (i.e F1, F2, etc.) and honeycombing is observed in the surface, penalty of Rs. 5000/- per Sq.m. will be imposed.
- 64.** Any recommendation / alteration in the work as per decision of Competent Authority of B.M.C. shall have to be executed under the same tender conditions.
- 65.** The Tenderer(s) shall implement anti-malarial measures for each site during execution of works in case of failure to implement above measures a penalty of Rs.5000/- per day per personnel shall be imposed.
- 66.** The contractors will have to obtain permission from the traffic police department well in advance either for closing down the road stretch or for diversion of traffic for execution of the work by displaying appropriate boards. The work may be required to be executed in phases as per traffic police permission. The contractors should therefore take this factor in to account while quoting.
- 67.** The guide wall of iron channels / brick masonry wall of sufficient section height shall be constructed to guide touch piles/meter panels for which no extra payment shall be

made. If longitudinal alignment of the touch pile/meter panel differ more than 50 mm a penalty of Rs. 5000/- per meter depth of pile / meter panel will be imposed.

68. The tenderer(s) should note that the work shall be carried out preferably during day time i.e. from 10.00 am to 05.00 pm only.
69. If the structures/encroachments including utilities coming in the alignment of the proposed work, the contractor shall have to arrange for the carrying out detail total station survey of the structures/encroachments
70. The contractors shall get the structures demolished from concerned Asst. Commissioner of ward for necessary working place to be made available for the subject work.
71. Even though the Tenderer(s) takes all the precautionary measures and by chance any workman is injured or dies due to negligence or otherwise, the Tenderer(s) will be responsible for the claims of damages by the workman or his legal heirs.
72. The Tenderer(s) has to check health of all the labourers employed by him at every fortnight and take precautionary measures and treatment as per the advice of Medical Officer. If record is not maintained by the Contractor, penalty of Rs. 1000/- per labour will be imposed.
73. The design of R.C.C. / structural work shall be obtained from Licensed Structural Engineer at the cost of the Tenderer(s).
74. Web Connectivity: The Tenderer(s) shall provide web connectivity to all above monitoring system. Web connectivity shall have minimum 1 MBPS Internet speed & 100% availability. Software should be intelligent. In case of connectivity failure it should maintain the pending files and send them as soon as it is connected. The Tenderer(s) shall make sure that the entire software and hardware solution is virus free.
75. Quantities of all items provided in the B.O.Q. may not be required to be executed depending upon site conditions. B.M.C. reserves right to make any changes in scope of work / reduction of part or whole work. The tenderer shall not be entitled to claim any damages/compensation etc. for less quantity executed or cancellation of whole work or part thereof.
76. The tenderer(s) shall note that during execution of work silt, excavated material, debris etc dumped on the public streets/places will have to be removed immediately as per direction of the Engineer-in-Charge, failing which the same will be got removed at their risk and cost.
77. The contractors shall provide proper safety gears to their staff, labors. Failure to provide safety gears as per above clause a penalty of Rs.1000/- per labour per day shall be imposed. The Tenderer(s) will be fully responsible towards the safety of staff and labors for the entire Contract period.
78. B.M.C. will appoint a consultant / Third party audit for quality/quantity audit, during execution period. Boards of size 4' x 3' showing all the necessary details should be displayed at each and every nalla site. For non-compliance of this condition, penalty of Rs.1000/- per day per site will be imposed on the contractors.

- 79.** Tenderer(s) shall pay building & other building worker welfare Cess @ 1% of construction cost as per Maharashtra State building & other building welfare Cess act 1996 to the B.M.C. in consultation with C.A. (Finance).
- a) Tenderer(s) should note that, there are only few access points in each Proposed work of this tender from where Machinery can be lowered for desilting work/ concreting work.
- b) Tenderer(s) should note that, for inaccessible portion of proposed work of this tender the same shall be desilted manually by engaging adequate labour force and desilted material shall be conveyed up to loading point by head load.
- c) If the contractor engages any machinery for collecting, carrying for lifting the silt from the Proposed work of this nalla system bed and if any damage appears to the nalla system bed or Retaining walls or any structure belongings to anybody due to impact of machines or due to any reasons the contractors will have to make good or such damages without any extra cost to B.M.C.
- 80.** Since the work under reference is time bound the work will have to be carried out beyond the normal specified working hours. (10.00 am to 5.00 pm) the tenderer(s) should make specific provisions for this contingency.
- 81.** The successful tenderer(s) shall provide lorries/dumpers & machineries as per prevailing norms of Mumbai RTO dept.
- 82.** All the necessary precautions, safety measures etc. for the contractors staff at the work site shall be the responsibility of the successful tenderer(s). The successful tenderer(s) shall also be liable for any injury to the life & damage to private, municipal or government properties if any caused by them during the operations connected with this work. In this if any legal issues arise in any term the contractors will be solely responsible for such kind of legal issues/disputes and B.M.C. will not be a party in this matter.
- 83.** All the tenderer(s) are advised to visit the site of work so as to ascertain the scope of work required for effective execution of work & also to ascertain difficulties of accesses/approach road, traffic restrictions on account of tidal conditions etc.
- 84.** The tenderer(s) shall take utmost care while transporting the wet silt/earth to dumping ground. The wet silt shall be transported in water tight vehicles to ensure that wet silt does not spill on the road and cause any accident in case of any such accident it will be the entire responsibility of the contractors to bear all the damage, claims, any untoward incidents if happened.
- 85.** The contractor shall make proper arrangement of lighting / focus during night hours at his risk and cost at site.
- 86.** The wood generated from tree cutting shall be deposited in the store of concern ward Horticulture Assistant / JTO & take acknowledgement for the same.
- 87.** The contractors shall carryout tree cutting / transplantation / work in consultation with ward Horticulture Assistant / JTO & obtain necessary completion certificate for the same.

- 88.** The silt must be transported within 48 hours to the specified dumping ground. However, in case of main roads, the silt will be transported by deploying vehicles immediately. The said vehicles shall be water tight. The wet silt shall not be allowed to drip out on the road during transportation.
- 89.** Tenderer(s) are hereby directed to take out C.A.R. (Contractors All Risk) Policy and Janta Policies as directed under Clause No. 44 and 70 of the General Conditions of Contract for civil works.
- 90.** The tenderer(s) shall carry out the entrusted work as per BOQ and specification meticulously.
- 91.** The successful tenderer(s) shall take jointly the bed / bank / service road initial levels at every 5.0 mt distance for the starting point of group allotted to the tenderer(s) before starting the work and submit the cross section as well as longitudinal section as per the directions of the Engineer In-charge free of cost. After completion of widening, deepening, cutting work again the successful tenderer(s) shall take jointly the bed / bank / service road final levels at every 5.0 mt. distance from the starting point of group allotted to the tenderer(s) and submit the cross section as well as longitudinal section as per the directions of the engineer In-charge free cost. The successful tenderer(s) shall provide necessary survey instruments for the survey work free of cost.
- 92.** No separate payment for any kind of transportation from site will be made for the work. Tenderer(s) should take cognizance of the same while quoting the bid.
- 93.** The royalties, taxes, charges, etc. for excavated material i.e. earth, rock, etc. will be borne by the contractors. As per revised policy of B.M.C., in case of municipal dumping, Contractors will be charged for tipping excess earth / material @ the rate of prevailing charges during execution of work. However, tipping charges including weighing the same shall have to be borne by the tenderer(s) for which no payment / reimbursement will be made. Considering these charges, tenderer(s) shall quote their percentage accordingly.
- 94.** All the directives regarding new policy for governing extra/ excess as per circular no. CA(F)/Projects/31 dated 26.10.2020, shall be followed.
- 95.** Responsibility of observance of terms & conditions of the contract and authenticity of inputs given and documents submitted shall be solely of the contractors. The staff / engineers shall not be held responsible for any lapse / mischief that may be observed during the course of execution.
- 96.** It is proposed to allow the tenderer(s) maximum upto 2 (two) private plots for dumping / unloading the desilted material/silt as per the work proposed.
- 97.** For transportation of excavated material no vehicular tracking system will be insisted since the item of transportation will not be paid.
- 98.** The tenderer(s) quoting/bidding for more than one work with respect to e-tender notice and intends to pay A.S.D. as specified in the tender then the tenderer(s) shall pay separate A.S.D. for each bid online before end date and time of bid submission. In

case the A.S.D. submitted is more than the percentage quoted by the bidder, then the percentage quoted shall prevail.

- 99.** If the tenderer(s) is lowest in more than one bid, independently qualifies the PQ criteria of corresponding bid where he is lowest and has sufficient bid capacity to bid then in such cases more than one tender can be awarded to such bidder. However, final decision in this regards shall be with Municipal Commissioner.
- 100.** For the purpose of working out current level of values for turnover, following multiplying factor shall be used:-

Sr.	Financial Year	Multiplying factor
1	2022-23	1.00
2	2021-22	1.10
3	2020-21	1.21
4	2019-20	1.33
5	2018-19	1.46

- 101.** One Tender per Tenderer(s) – Each tenderer(s) shall submit online only one tender for one work. Tenderer(s) who submits more than one bid for one work, individually will cause all the proposals with the tenderer(s) participation to be disqualified.
- a) Firms with common proprietors/ partners connected with one another either financially or as principal agent or as master and servant or with proprietor/partners closely related with each other such as minor son/daughter and minor brother/sister shall not tender separately under different names for the same contract.
- b) If it is found that firms described vide above clause have tendered separately under different names for the same contract, all such tenders shall stand rejected and tender deposits shall be forfeited. Any contract entered into under such conditions will also be liable to be cancelled at any time during its currency and penal action including black listing of such firms will be taken.

102. Cost of Tendering-

The tenderer(s) shall bear all costs associated with the preparation, submission and uploading of his Tender, and the B.M.C. will in no case be responsible and liable for those costs.

- 103. Work Records:** - All specified up to date site record should be maintained by the contractors. If the Tenderer(s) fails to comply with this condition, the penalty of Rs.1000/- per day per record will be imposed on the contractors.

List of Registers	
Sr. No.	Name of Register
1.	Inventory Register
2.	Correspondence file
3.	External & internal utility remarks file

4.	File containing drawings
5.	Daily Progress Register
6.	Instruction Register
7.	Level Book
8.	Mix design file
9.	Materials Testing Result file
10.	Photograph file
11.	Excavation Register (Asphalt , rock, soil etc)
12.	Filling/Embankment Register
13.	Granular Sub-base / K.T.R.Register
14.	Wet mix Macadam ./ Water Bound Macadam .Register
15.	Sand Metal Filling Register
16.	Misc work register
17.	M 15 CC Register
18.	M 20 CC Register
19.	M 40 CC Register
20.	M15,M20, M35/M40 Cube & Beam registers
21.	Ready Mix Concrete Challan file
22.	Cement Variation Register
23.	Cement Register
24.	Asphalt macadam (mixes) register
25.	Dense Bituminous Macadam Register
26.	Asphalt concrete /Seal coat Register
27.	Asphalt challan file
28.	Penalty Register.
29.	Steel register
30.	Visual/ video recordings in form of CD's
31.	Form work shuttering register
32.	Precast register
33.	Any other register as per directions of Engineer in Charge.
NOTE :	From above list the registers applicable for the specified work shall be maintained.

104. Minimum 2 security guards round the clock shall be provided on every worksite. A penalty of Rs 500/- per security guard per shift will be levied if the same is not provided.

105. Pre-bid meeting – (Applicable for tenders costing above Rs.25 Crores) :-

- a) The tenderer(s) or his authorized representative is invited to attend a pre-bid meeting as per the date, time and venue mentioned in the tender notice/header data.
- b) The purpose of the meeting will be to clarify issues and to answer questions on any matter that may be raised at that stage.
- c) Any tenderer(s) requiring any clarification of the tender document and/or the works may submit his questions in writing to reach the office of **Ch.E. (SWD)** at least 2 days before the meeting.
- d) The text of the questions raised (without identifying the source of enquiry) and the response given will be circulated/informed vide addendum on B.M.C. portal /displayed

on Notice board of respective Zonal office within 7 days. Any modification of the tendering documents, which may become necessary as a result of the pre-bid meeting, shall be made by the B.M.C. exclusively through the issue of an Addendum and not through the minutes of the pre-bid meeting.

- e) Non-attendance at the pre-bid meeting will not be a cause for disqualification of tenderer(s).

106. Any affected party / tenderer(s) may appeal before DMC / Director (E.S. & P) / AMC as per circular no. CA/FRD-I/5 dated 10.05.2016 regarding their grievances pertaining to the tender under reference. The affected party may approach Procurement Redressal Committee (PRC) later on only after hearing conducted before DMC / Director (E.S. & P)/AMC initially.

107. Information regarding Classes –

Classes classified in M.C.G.M with limits of works, standing Deposit, amount of solvency prescribed for each class. :-

Class	Works Limit (Rs.)	Solvency Amount (Rs. in Lakhs)
	Rs.	Rs.
AA	Without Limit	60
A	Up to 3 Crores	30
B	Up to 1 Crores	20
C	Up to 50 Lakhs	15
D	Up to 25 Lakhs	10
E	Up to 10 Lakhs	5

Classes classified in M.C.G.M with limits of works, standing Deposit, amount of solvency prescribed for each class as per New Registration Rules 2016:-

Class	Upper Limit of Tendering (Rs.in Lakhs)	Minimum Solvency (Rs.in Lakhs)
I(A)	Without Limit	150
I(B)	2500	
I(C)	1500	
II	750	75
III	300	30
IV	150	15
IV(A)	90	9
V	50	5
V(A)	30	3
VI	15	2
VII	7	1
VIII	3	0.50
IX	2	0.25

(Please refer Rules Governing Registration of Contractors for Civil and Mechanical & Electrical Engineering works 2016)

108. A responsive tender is one, which confirms to all the terms, conditions and specifications of the tendering documents, without material deviation or reservation a material deviation or reservation is one-

- a) Which affects in any way the scope, quality or Performance of the work.
- b) which limits in any way, the employer's rights or the tenderer(s) obligation under the contract and inconsistent with tendering documents.
- c) Whose rectification would affect unfairly the competitive position of other tenderer(s) presenting responsive tenders.

109. Dumping Grounds– Mention of the Municipal dumping sites in tender document does not cast any responsibility upon B.M.C. to make the same available to successful bidder. It all depends on availability of the dumping grounds. B.M.C. does not claim to make the Municipal dumping sites available to the successful contractor.

- a) The dumping sites may change at the discretion of Engineer at short notice, without any financial liability on B.M.C.
- b) B.M.C. does not assume any responsibility for providing sites for dumping ground for removal and transportation of surplus excavated earth including de-silted material. In the event of Municipal dumping ground not available; the successful bidder shall have to make his own suitable arrangements for disposal of excavated surplus earth/ material / desilted material at his own risk and cost.
- c) **“B.M.C. will not make any payment towards transportation/ removal/ disposal of excavated surplus earth/ material / desilted material from construction site to either Municipal dumping ground (if available) or contractors own dumping facility. Contractors shall quote accordingly”.**
- d) Nevertheless, B.M.C. reserves its rights to use surplus excavated materials for its own use anywhere in B.M.C. limits and the contractor will have to dump the material at any sites as decided and directed by the engineer in charge; no extra payment will be made on this account.

110. If the site is affected due to Tidal effect and to facilitate construction activity Cofferdams will have to be constructed by the tenderer(s) and also tenderer(s) have to construct temporary road, F.O.B, etc while constructing the Nalla for which no extra

payment will be made. Tenderer(s) need to consider this aspect at the time of quoting the Bid.

111. Above all any new guidelines or changes in existing system regarding keeping a check on the transportation of vehicles to private dumping ground will be binding on contractors and no extra payment what so ever will be made to the tenderer(s) in lieu any changes made or fresh guidelines issued.

112. The Bidder/Contractor has to appoint Structural consultant from M.C.G.M Registered / licensed Structural Engineer OR Renowned agencies like I.I.T/ V.J.T.I./S.P.C.E. for design and supervision of the works designed by them during execution the work and shall inform to BMC before execution of the work. Bidder shall submit the Structural Stability certificate from the appointed consultant who has supervised the work after completion and before submission of the final bill. Tenderer shall take note of the same while quoting the bid.

113. Tenderers shall have to follow the New Guidelines & Modalities for execution of Engineering Works circulated by Ch.E.(Vigilance) department u/no. ChE/Vig /1581/B dated 21.09.2016.

114. Methodology of the work, safety manual and quality assurance plan shall be submitted before commencement of the work with copy at each site office.

115. Concrete Works:

All concrete works shall be carried out as per item description or by Ready Mix Concrete only.

116. The work should be started from downstream and shall be handed over and commissioned in part as per the progress of the works. DLP of the part handed over SWD/ sewer line will be counted from the date of handing over.

117. Diameter of the pipe and sizes of manholes provided in the bill of Quantities of the Tenders are tentative and are likely to change at the time of execution according to the site conditions. Contractors shall have to carry out such extra items in Sewer Line/Water mains works as per respective Schedule rates of B.M.C. prevailing at the time of execution of work adjusted by rebate/premium quoted by the contractors and no fair rate will be admissible for the same.

- 118.a)** The Mix Design for Concrete shall invariably include details of source material including tests carried out at source (Quarry/Cement Manufacturer's lab).
- b) The contractors should carry out if required, any minor works such as raising/lowering of manhole, attending to bad spots, bad patches etc. as may be decided by the Engineer-in charge anywhere within the concerned ward limit where the work is in progress under contract at the rates included in the Bill of Quantities of the above work with his percentage quoted.
- 119.i)** All the specifications lay down by IRC and as detailed in the relevant clauses of MoRTH- (2001) Manual on Specifications for Road and Bridge Works in respect of Construction of Drainage Layer, Wet Mix Macadam, Dry Lean Concrete should be strictly followed.
- ii) All the works for thin/ ultra thin white topping shall be carried out as per IRC – SP - 76.
- 120.** It will be the responsibility of the contractors to arrange for a joint inspection in every quarter of the year after completion of the work till the expiry of defect liability period and also 4 weeks before expiry of the defect liability period. Further, if the contractor fails to do so, the observations made by the staff during site inspection will be considered for the purpose of noting the defects.
- 121.(i)** All the works shall be started from existing manhole at the downstream end of the proposed work so that the line laid will be put to use immediately.
- (ii) All the existing street connections / cross sewer lines shall be transferred to the proposed/existing sewer line, if any.
- (iii) The work may involves laying of augmentation of storm water line on narrow Gaothan street having existing utility such as Sewers, Water mains. At some location, proposed storm work will required to be carried out by dismantling existing sewer line and redo the same. It is likely that the new storm water line will be laid on existing alignment by isolating the same. The bidder has to desilt the existing storm water drain wherever required at their own cost.
- (iv) Before redoing of culvert work, the design of R.C.C./ Structural work shall be obtained from licensed Structural Engineer at the cost of tenderer.
- 122.** The Contractors may be called upon to execute additional work of laying small portion of storm water line/ sewer line in the vicinity of the present work under the proposed

Contract. This fact should be taken into consideration while quoting the percentages or rates for the tender of the work.

- 123.** The contractor which expression shall include any person or group of person's representing the contractor who are required to handle iron and steel materials shall register themselves as employer with the Mumbai Iron and Steel Labour board and shall completely fulfill all the obligatory provisions of the Maharashtra Mathadi, Hamal other Manual Workers (Regulation of employment and Welfare) Act 1969, and the Mumbai Iron and Steel Unprotected Workers (Regulation of employment and Welfare) Scheme 1970. The consequences of failure of compliance of any of these provisions will entirely be the liability and responsibility of the Contractors.
- 124.** Any amount of Dewatering required for crossing nalla/culvert/S. W. drains, crossing of sewer lines etc. and also for making connection of the proposed SWD/sewer lines to the existing sewer line in surcharge conditions should be done free of cost. No payment will be made on that account. Contractor shall note the same and quote accordingly.
- 125.** The item of the constructing body manhole over functioning / nonfunctioning SWD/sewer of any diameter will be paid in regular manhole item which includes the cost of breaking of concrete and pipe, desilting of SWD/sewer line, dewatering of SWD/sewer line, etc. The contractor should quote their rates accordingly.
- 126.** The contractors will have to make connections to the existing manhole including plugging, diverting or pumping the existing flow or accumulated water, making holes of any size in the masonry, breaking the existing cement concrete haunches, making sand plaster, constructing new channels and haunches with M 15 C. C. finished smooth with 20 mm. (3/4") thick cement mortar 1:1, de-plugging and desilting the manhole on upstream side and downstream including passing disc in the length complete as directed (for this item no payment will be given to the contractors).
- 127.** Where the excavation is required to be done across the road or along the part of a road where there is high volume of traffic, the Engineer may direct the contractor, to execute the work in more than one shift, so as to complete the work, in least required time, so as to reduce the inconvenience caused to the free flow of traffic. Arrangement will have to be made by the contractor to provide additional lights, sign boards etc. as required by the Engineer and traffic police. The contractor will have to provide M.S. plates of

sufficient thickness, including stiffer plates for strengthening with supporting joints, if required, to cover the open trenches during the day time for smooth flow of traffic during the progress of the work and till the trench is backfilled. No extra payment will be made for this arrangement. The program of the work to be done in additional shifts shall be submitted to the Engineer and got approved before starting the work, so that the work can be completed in a time bound manner.

- 128.** It should be clearly understood that for the purpose of determination of the contract period, the monsoon period will be taken only as from 10th June to 30th September, and all works shall be recommenced on 1st of October, irrespective of whether there are intervening festivals and/or rains etc.
- 129.** Contractor will make arrangement to inspect R.C. pipe / H.D.P.E. pipe manufacturer's site to carry out three edge bearing tests, water tightness test.
- 130.** No material will be supplied by B.M.C. Stores.
- 131.** The per cent above or below quoted in this schedule shall hold good for all works done under this contract without reference to location of works or quantities.
- 132.** The contractors are particularly directed to observe from the specifications what is to be included in the rates for the several portions of the works and frame all their per cent above or below accordingly.
- 133.** It is incumbent on the Contractors to remove all "Pardis" put up by them during the progress of storm water work so as to obviate the necessity of such removal after the storm water is put into commission while handing over charge of such storm water line to the respective Department. If any such "Pardi" is found after the Storm water line is put into commission the cost of breaking and removing the same will be recovered from the Contractors.
- 134.** After completing the work, completion plan shall be sent to the Dy. Chief Engineer (SWD) ES.
- 135.** In respect of Filling in trenches with Municipal earth materials etc. in layers not exceeding 25cm. in loose thickness, watering etc. compacting by means of plate vibrator or a power roller to a depth not exceeding 2m. etc. complete as per New Road Specifications / trench guidelines effective from 01.02.2015.

- 136.** Scope of Work includes minor changes in alignment due to site difficulties, if arises. Contractors are liable to carry out the SWD/sewer work as instructed by the Engineer of Contract.
- 137.** Tenderer shall have to provide an air-conditioned site office admeasuringabout 20 sq.m. (Minimum) with at least two windows and with all the security kits and safety measures for labourers shall be provided by the tenderers along with the conditions mentioned in Clause no.68. 5. and 68. 6. of GCC of this document. Also Digital camera with minimum 16 Mega Pixel lenses shall be provided for the tendered work.
- 138.** Tenderer shall obtain NOC before commencement of work from SWM department towards C & D waste generated during execution of work in accordance with the provisions of Construction and Demolition Waste Management Rules 2016 and in consonance with the circular issued under no. Dy.Ch.Eng./SWD/3957/Op dt. 28.09.2018.
- 139.** In case of non-satisfactory / failed results of 28 days concrete compressive strength, if 28 days concrete cube compressive strength test samples at MTL / Private NABL accredited labs are not satisfactory / failed; in such circumstances, the reassessment of strength of concrete shall invariably to be done only at Municipal testing laboratory (MTL) by joint witness by the officer not below the rank of Assistant Engineer of the project & the representative of the contractor for assurance & acceptance of the strength of concrete work.
- 140.** Reconfirmation / Reassessment of concrete strength at Municipal approved private NABL accredited labs shall not be allowed.
- 141.** In case of failure of reconfirmation of test reports, the action as per provisions of 8(f) of SGCC shall be strictly initiated by Dy.Ch.Eng.(SWD)ES department by obtaining the prior approval of concerned HOD.
- 142.** SPECIFICATIONS FOR ITEMS OF BARRICADING. Barricading shall be as per circular No MGC-F-6342 dated 05.05.2018 (copy uploaded with this tender) and as per the new design (copy uploaded with this tender). It will be binding on the qualifying bidder/agency to install the GPS trackers at the starting and end barricades provided along each work site. The installed GPS trackers shall be kept in working condition till the completion of the works. While shifting the barricades care shall be taken to keep the GPS tracker barricades at the site if the work is not completed. Further, The QR Code shall be provided on each panel of barricades and shall following information of the sites Viz. name of work, name of the contractors, name of all contractor's staff appointed for this particular project, Date of start and completion of the work, etc., and as required by Engineer-In-charge. Each Barricade shall have LED rope lighting which shall be kept on between sunset and sunrise or as directed by engineer-incharge. Any innovative design/slogan/message as directed by the Engineer incharge shall be displayed on said barricade. No extra payment will be made for the installation of the barricades or for providing the design/slogan/message/reflectors or the LED lighting or the installed GPS

trackers as stated; contractors shall note the same and quote accordingly. The cost of power supply to the LED rope light shall be borne by the contractor and he shall quote the bid accordingly.

If barricades are not provided as per specification, the following penalties will be levied:

Sr.no.	For each Instance at each road	Penalty in Rs. Per Day
1	1 st instance	5,00,000/-
2	From 2nd instance onwards	10,00,000/-

Penalty will be proposed by SE and AE and approved by Engineer-in-charge E.E.(SWD).

Digital Signature of Tenderer(s)

SECTION – 16
LIST OF WORKS

**Training & widening of LaxmibaugNalla at
Sidhrameshwar Nagar, Ghatkopar(E) in N Ward.**

SECTION – 17
LOCATION PLAN

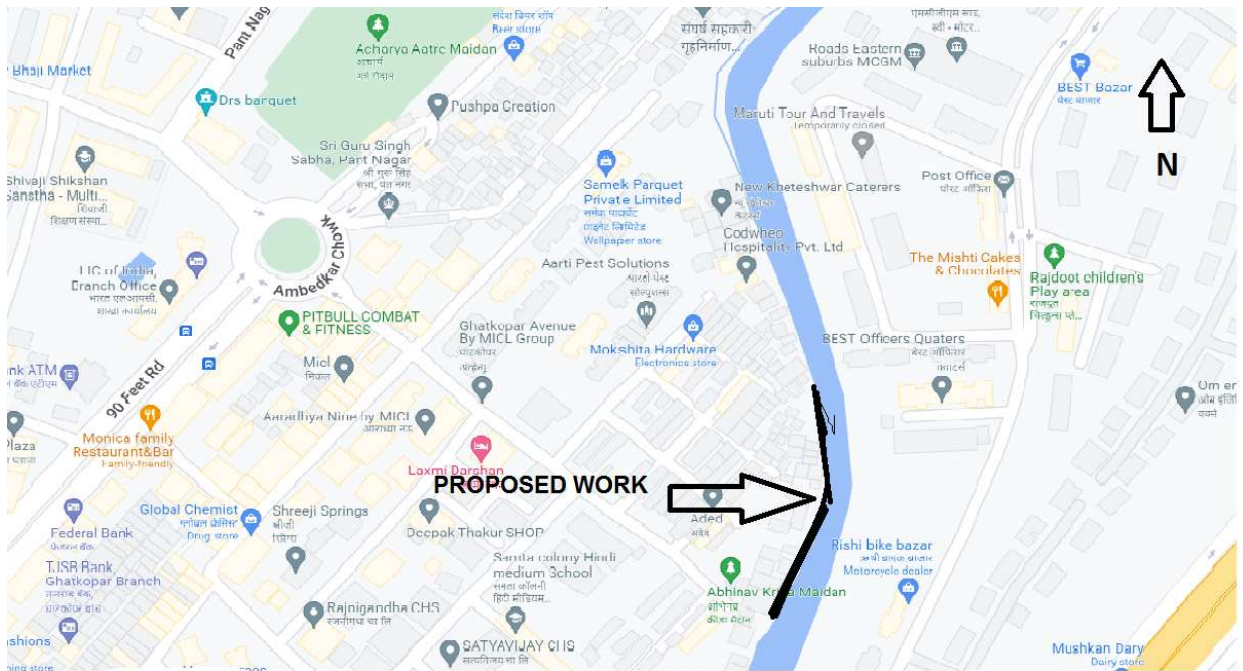

Training and Widening of Laxmibaug nalla at Sidhrameshwar Nagar, Ghatkopar (E) in N Ward.

SECTION – 18
TYPICAL DRAWING

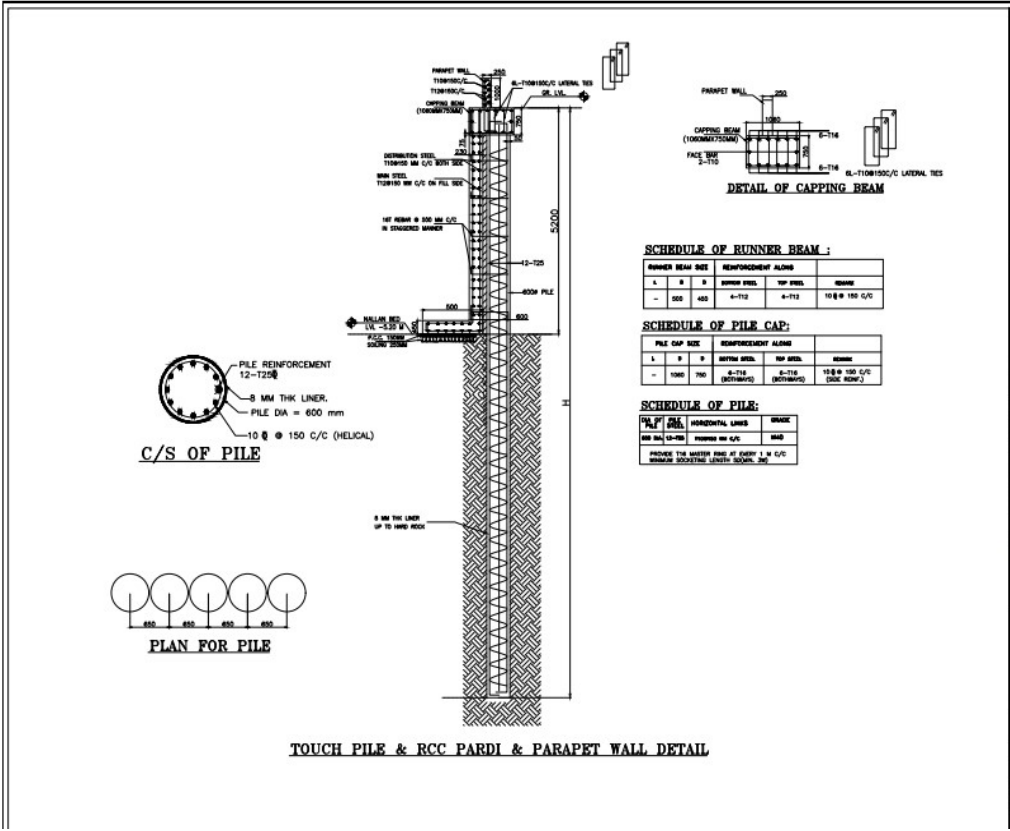

SECTION – 19

Reference circulars

**FROM THE DESK OF THE
MUNICIPAL COMMISSIONER**

No. MGC/A/9895

Date: 21/8/19

During the review of progress of Major projects, it is observed that in most of the cases project timelines specified in a tender are not achieved. The reasons stated by the concerned engineers for not achieving the timeline are very frivolous. Henceforth, all Chief Engineers/HoDs/DyCh Engineers shall note that, the timeline specified in the tender document for completion of project shall be met accurately. Failure to achieve the timeline will be viewed very seriously & 50% of salary of every month of concerned Executive Engineer will be deducted for extended period of project completion & 20% of contractual payment of contractor will be deducted.

Further, if work order for any project is issued, other departments cross cutting issues like removal of encroachment, providing PAP's, shifting of utilities, approval of plan etc. be resolved by the concerned officers of MCGM. If, it has not resolved at their level, they should escalate to Addl. Municipal Commissioner level who shall then take joint meeting of project implementing agency and concerned HoDiAC who is responsible for resolving the cross cutting issues & resolve the difficulties for implementing the project expeditiously.

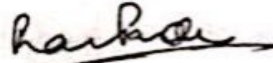

Municipal Commissioner

All Addl. MCs
All DMCs/Dir(ES&P)/DMC(S.E./VDMC(E))
All Chief Engineers
All ACs

Copy to: _____

CHERADS) / SWD / Bridges / CE
CHERAM) / HIC / SIC / Garden call
EE

- 1) Please note the above directions to Hon. M.C.
- 2) Every 15 days the review to be taken by concerned EE.
- 3) All CE's to take review before 5th of every month for all projects and if there is any issue for program the matter must be reported to Director of S&P



Scanned with
CamScanner

BRIHANMUMBAI MAHANAGAR PALIKA

No. Dy.ChE / /SWD / WS - Dtd / /2019

4017

16 AUG 2019

Subject :- Adoption of uniform cross-section for drains under footpath, culverts, drains flush with carriageways, etc, in S.W.D. Department.

The SWD Department undertakes various works, such as construction of SWD under footpath, box drains flush to road, culverts, carriageway entrances, etc. to abate flooding. It is observed that while preparing estimates, there is non-uniformity in the cross sections and quantity of steel per cubic meter of concrete.

Due to the non-uniformity of cross section and higher grade of concrete adopted for miscellaneous structural sections, Vigilance Department had raised objections to the same.

In order to avoid this and bring uniformity in the preparation of estimates within the department of SWD, following sections and quantity of steel for drains under footpaths, culverts, drains flush to road, are proposed to be adopted as under :-

Sr. No.	Description	Width of Drain / Waterway	Grade of Concrete	Item No	Rate/ Cum	Max. quantity of Steel per cu.m. (FE 500D)
A	Below Footpath drain	0.6 to 1.2mtr	M-25			
	Raft	200mm		R2-SWD-25	Rs. 6979/-	80Kg
	Wall	250mm		R2-SWD-30	Rs. 8735/-	80Kg
	Slab	250mm		R2-SWD-30	Rs. 8735/-	90Kg



Scanned with CamScanner

Description	Width of Drain	Grade of Concrete	Item No	Rate/ Cum	Max. quantity of Steel per cu.m. (FE 500D)
Flush Drain / Cross Culverts / Carriageway	0.6 to 1.2mtr	M-40			
Raft	250mm		R2-SWD-178	Rs. 7777/-	80Kg
Wall	250mm		R2-SWD-179	Rs. 9569/-	100Kg
Slab	300mm		R2-SWD-179	Rs. 9569	100Kg
C Flush Drain / Cross Culverts / Carriageway	More than 1.2mtr	M-40			
Raft	300mm		R2-SWD-178	Rs. 7777/-	100Kg
Wall	300mm		R2-SWD-179	Rs. 9569/-	120Kg
Slab	300mm		R2-SWD-179	Rs. 9569/-	120Kg

The sanction of Dy.Ch.E.(SWD) W.S./Ch.E.(SWD) is requested to adopt the said sections, grade of concrete & percentage of steel for estimation purpose. The detailed structural design from empanelled structural engineers will be submitted by the appointed contractor as per tender conditions and the same section will be approved after examining as per general practice in force.

Submitted for approval, please.

 13/8/19
 E.E.(S.W.D.) W.S.Z-III
  13/8/19
 E.E.(S.W.D.) W.S.Z-IV
  13/8/19
 E.E.(SWD) W.S.Z-VII

~~Dy.Ch.E.(SWD) W.S.~~

~~Ch.E.(S.W.D.)~~

Sir,

As proposed.
Pl. circulate to Dy.Ch.E.(SWD) & Ch.E.

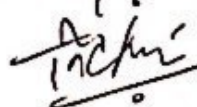
 14/8/19
Ch.E.(SWD)



MUNICIPAL CORPORATION OF GREATER MUMBAI

No. : MGC/F/8659 Dtd. 07.09.2019.

Sub : Arbitration clause in the Standard General Conditions of Contract for Construction Works, 2016.

In one of the cases of W.S.P. regarding arbitration. dispute, a note was submitted by DyLaw Officer (High Court, Suit & PIL) and subsequently the report is submitted by Jt. M.C. (Vig.) vide No. Jt.M.C./Vig./69/MC dtd. 21-8-2019 proposing a process to deal with the arbitration matters as per the Law & Judiciary, Govt. of Maharashtra, policy for institutional arbitration vide it's G.R. dtd. 13-10-2016 and the report submitted by Jt. M.C. (Vig.) is approved by Hon'ble M.C. on 17-8-2019.

There is a provision of arbitration clause in the Standard General Condition of Contract for Construction Works, point no. 13 (e) reads as follows :-

13.e) Arbitration and Jurisdiction:

If the Commissioner shall fail to give notice of the decision as aforesaid within a period of 90 days after being requested as aforesaid, or if the Contractor be dissatisfied with any such decision, then and in any such case the Contractor may within 90 days after receiving notice of such decision or within 90 days after the expirations of the first named period of 90 days (as the case may be) require that the matter or matters in dispute be referred to arbitration as hereinafter provided. All disputes or differences in respect of which the decision (if any) of the Commissioner has not become final and binding as aforesaid shall be finally settled by arbitration as follows:

Arbitration shall be effected by a single arbitrator agreed upon the parties. The arbitration shall be conducted in accordance with the provisions of the Arbitration Act, 1996 or any statutory modifications thereof, and shall be held at such place and time within the limits of Brihan Mumbai as the arbitrator may determine. The decision of the arbitrator shall be final and binding upon the parties hereto and the expense of the arbitration shall be paid as may be determined by the arbitrator. Performance under the Contract shall, if reasonably be possible, continued during the arbitration proceedings and payment due to the Contractor by the Employer shall not be withheld unless they are the subject matter of arbitration proceedings. The said arbitrator shall have full power to open up, review and revise any decision, opinion, direction, certification or valuation of the Commissioner and neither party shall be limited in the proceedings before such arbitrator to the evidence or arguments put before the Commissioner for the purpose of obtaining his said decision.

No decision given by the Commissioner in accordance with the foregoing provisions shall disqualify him from being called as a witness and giving evidence before the arbitrator on any matters whatsoever relevant to the disputes or difference referred to the arbitrator as aforesaid.

All awards shall be in writing and for claims equivalent to 5,00,000 or more such awards shall state reasons for amounts awarded. The expenditure of arbitration shall be paid as may be determined by arbitrator.

In case of any claim, dispute or difference arising in respect of a contract, the cause of action thereof shall be deemed to have arisen in Mumbai and all legal proceedings in respect of any claim, dispute or difference shall be instituted in a competent court in the City of Mumbai only.

As per Hon'ble M.C's approval dtd. 17-8-2019, the existing clause is now replaced as follows :

13.e Arbitration and Jurisdiction

If the Commissioner fails to give notice of the decision as aforesaid within a period of 90 days after being requested as aforesaid or if the Contractor is dissatisfied with any such decision, then the Contractor may within 90 days after receiving notice of such decision or within 90 days after the expiration of the first named period of 90 days (as the case may be) require that the matter or matters in dispute be referred to arbitration as hereinafter provided.

i) In case of a contract where the contract price and/ or contract value is less than Rs. 5,00,00,000/- (Rupees Five Crore Only), any dispute arising out of or in connection with this contract, including any question regarding its existence, validity or termination, shall be referred to a mutually agreed arbitral tribunal in accordance with the Arbitration and Conciliation Act, 1996 (amended upto date). The arbitral tribunal shall consist of a sole arbitrator, as mutually agreed upon by the parties and the said dispute shall be finally resolved by the said arbitral tribunal. The decision of the arbitral tribunal shall be in writing (with reasons) and which will be final and binding upon the parties hereto and the expenses of the arbitration shall be paid as may be determined by the arbitral tribunal. The seat of the arbitration shall be Mumbai. The venue of arbitration shall be within the limits of Brihan Mumbai. The language of the Arbitration shall be English.

If the parties fails to appoint mutually agreed arbitral tribunal, within the period of 30 days from the date of application seeking arbitration in the dispute,

No.. : DIR/ES&P/919/MC dtd. 16.09.2019.

C.C. to : DMC(MCO)/ Jt.MC(GA)/ DMC(SE) / DMC(E)/ DMC(CPD)/
Jt.MC(SWM)/ DMC(Z-I) / DMC(Z-II) / DMC(Z-III) / Jt.MC(Z-IV) / Jt.MC(Z-V)/
DMC(Z-VI)/ Jt.MC(Z-VII) / D.M.C. (PH) / DMC (Edu.) / DMC (RE) / DMC (DM)

Forwarded for information please.

o/c
Director (E.S.& P.)
16/09/19

No.. : DIR/ES&P/919/MC dtd. 16.09.2019.

C.C. to: Law Officer

For compliance of para 'Y' at Pg. N/35 at your end and do the needful as per Hon'ble M.C.'s order. Original file is forwarded herewith.

o/c
Director (E.S.& P.)
16/09/19

No.. : DIR/ES&P/919/MC dtd. 16.09.2019.

C.C. to:

As per the note of Law Officer u/no. LO/LOP/3110/ Dy.LO (H.C. suits & PIL) dt.28.08.2019, the clause as modified by Law Officer & which is approved by Hon'ble M.C. is included in the circular please while issuing the circular.

Submitted please.

o/c
Director (E.S.& P.)
16/09/19

Jt.MC(Vig)/A.M.C.(City) / A.M.C.(E.S.) / A.M.C(W.S) / A.M.C(P)

Sir/Madam,

Hon'ble M.C.

Sir,

o/c

बृहन्मुंबई महानगरपालिका

परिपत्रक

२०२०-२१

क्र.प्रले(वित्त)/प्रकल्प/२१ दिनांक ०७.०६.२०२०

विषय: बृहन्मुंबई महानगरपालिकेची कामे करणाऱ्या कंत्राटदारांना चालू कंत्राटामधील अडचणीबाबत उपाययोजना व सहाय्य करणे (Contract Deposit and Retention Money)

- संदर्भ: १) महाराष्ट्र शासन परिपत्रक क्रमांक संकीर्ण-१०२०/प्र.क्र./१००/२०२० -व्यय-१२ दिनांक २९ जूलै, २०२०
२) क्र.उपप्रले/व्यय/१/०६ दिनांक १०.०८.२०२०
३) क्र.प्रले(वित्त)/प्रकल्प/२० दिनांक २०.०८.२०२०

केंद्र सरकार व राज्य सरकारने 'कोविड-१९' या महासाथीच्या कालावधीमध्ये मार्गदर्शक सूचना जारी करून लॉकडाऊन जाहीर केले. लॉकडाऊनच्या कालावधीमध्ये आपत्ती व्यवस्थापन कायदा, २००५ नुसार घातलेल्या निर्बंधामुळे बृहन्मुंबई महानगरपालिकेमार्फत राबविण्यात येणाऱ्या प्रकल्पांची गती मंदावली आहे. महाराष्ट्र शासनाने परिपत्रक क्र.संकीर्ण-१०२०/प्र.क्र.१००/२०२०/व्यय१२ दिनांक २९.०७.२०२० च्या अनुषंगाने तसेच कार्यानुरूप हमी परत करून सहाय्य करण्याच्या अनुषंगानेही संदर्भित परिपत्रक प्रसारीत केलेले आहे. तथापि, याबाबत आणखी प्राप्त झालेल्या सूचना/मार्गदर्शन यानुसार सदर धोरण निश्चित करण्यात येत आहे.

बृहन्मुंबई महानगरपालिकेमध्ये सध्या प्रकल्प व इतर कामांकरिता खालीलप्रमाणे सुरक्षा अनामत रक्कम व रिटेंशन मनी प्राप्त करण्यात येत आहेत:-

तक्ता क्रमांक - १

अनु. क्र.	सुरक्षा अनामत रकमेचा प्रकार	टक्केवारी	रक्कमेचे स्वरूप	परतावा निकष
१.	कंत्राट/सुरक्षा अनामत रक्कम (कॉन्ट्रॅक्ट सम वर)	२% व त्यापेक्षा जास्त	बँक हमीपत्र	दोष दायित्व कालावधी १/२/३ वर्षे असल्यास दोष दायित्व कालावधी संपल्यानंतर आणि दोष दायित्व कालावधी ५ वर्षे असल्यास दोष दायित्व कालावधीच्या ३ वर्षांनंतर.

२.	रिटेंशन मनी (काँट्रॅक्ट सम वर)	चालू देयकातून ५%	अ) रोख (देयकातून वळती) ब) बँक हमीपत्रामध्ये परावर्तीत केलेली	५०% काम पूर्ततेनंतर व उर्वरित ५०% दोष दायित्व कालावधी १/२/३ वर्षे असल्यास दोष दायित्व कालावधी संपल्यानंतर आणि दोष दायित्व कालावधी ५ वर्षे असल्यास दोष दायित्व कालावधीच्या ३ वर्षानंतर.
३.	परफॉर्मन्स गॅरंटी (काँट्रॅक्ट सम वर)	निविदा दरात अधिमुल्य/सममुल्य व १२% पर्यंत सूट असल्यास ०.९२% १२% पेक्षा जास्त सूट असल्यास ०.९२% अधिक १२% पेक्षा जास्त सूटीचा टक्का किंवा त्याचा भाग यास १% या प्रमाणे	बँक हमीपत्र स्वरूपात	दोष दायित्व कालावधी संपल्यानंतर.
४.	अतिरिक्त सुरक्षा अनामत रक्कम (ASD) (कार्यालयीन अंदाजावर)	निविदेत प्रतिसाद १२% रकमेपेक्षा जास्त सूट दिल्यास प्रत्येक टक्का किंवा त्याच्या भागास १% प्रमाणे	रोख (निविदा सादर करतेवेळी ऑनलाईन अधिदान.)	काम पूर्ततेनंतर.

महानगरपालिकेने राज्य शासनाच्या धर्तीवर Retention Money बँक हमीपत्रात परावर्तीत करण्याबाबत तसेच ५०% काम पूर्ण झालेले असल्यास अतिरिक्त सुरक्षा अनामत रक्कम (ASD) ५०% परत करण्यास व उर्वरित रक्कम बँक हमीपत्रात परावर्तीत करण्यास संदर्भित क्र. २ अन्वये तसेच कार्यानुरूप हमी कंत्राटदारांना परत करून सहाय्य करण्याबाबतही संदर्भित क्र. ३ अन्वये परिपत्रक प्रसारीत केलेले आहे.. त्यामुळे प्राप्त वाढीव मागणीप्रमाणे कोव्हिड-१९ मुळे उद्भवलेल्या परिस्थितीवर मात करून महानगरपालिकेतील कामे विहित वेळेत पूर्ण होण्याच्या दृष्टीने तसेच आलेल्या वेगवेगळ्या मागण्यांचा एकत्रित

विचार करुन महानगरपालिकेतील कंत्राटदारांना Contract Deposit and Retention Money मध्ये खालीलप्रमाणे बदल करुन अतिरिक्त सहाय्य/सवलत/परतावा देण्यात येत आहे.

तक्ता क्रमांक - २

अनु. क्र.	सुरक्षा अनामत रकमेचा प्रकार	टक्केवारी	रक्कम	परतावा निकष
१.	कंत्राट/सुरक्षा अनामत रक्कम	२%	बँक हमीपत्र	दोष दायित्व कालावधी १/२/३वर्षे असल्यास दोष दायित्व कालावधी संपल्यानंतर आणि दोष दायित्व कालावधी ५ वर्षे असल्यास दोष दायित्व कालावधीच्या ३ वर्षांनंतर
२.	रिटेंशन मनी	२% (चालू देयक रकमेच्या)	अ)रोख (देयकातून वळती) ब)बँक हमीपत्रामध्ये परावर्तीत केलेली	५०% काम पूर्ततेनंतर व उर्वरित ५०% दोष दायित्व कालावधी १/२/३वर्षे असल्यास दोष दायित्व कालावधी संपल्यानंतर आणि दोष दायित्व कालावधी ५ वर्षे असल्यास दोष दायित्व कालावधीच्या ३ वर्षांनंतर

तथापि, निविदाकाराने निविदा सादर करताना निविदेमध्ये नमूद असलेली सुरक्षा अनामत व रिटेंशन मनीची रक्कम विचारात घेऊन निविदेचे दर भरलेले आहे. त्यामुळे उपरोक्त तक्ता क्र. २ प्रमाणे सुरक्षा अनामत व रिटेंशन मनीची रक्कम कमी केल्यामुळे निविदाकाराला नमूद दरामध्ये अतिरिक्त आर्थिक फायदा होणार आहे. त्यामुळे सदर फायदा अंदाजे किती होणार आहे हे निश्चित करुन कंत्राटदाराची bid price त्याप्रमाणात कमी करणे आवश्यक आहे. सदर रकमेच्या परिगणनासाठी खालीलप्रमाणे काही धारणा (assumptions) गृहीत धरल्या आहेत :-

I) स्थायी धारणा (fixed assumptions)

१. व्याजाचा दर द.सा.द.शे. ६%
२. बँक गॅरंटी प्राप्त करण्यासाठी १/३ कॅश मार्जिन
३. समान रकमेचे तिमाही अधिदान

II) अस्थायी धारणा (variable assumptions)

१. कंत्राट रक्कम
२. कंत्राट कालावधी
३. दोष दायित्व कालावधी
४. सुरक्षा अनामत रक्कम/रिटेंशन मनी

प्रत्येक कामाचा कंत्राट कालावधी वेगवेगळा राहणार असल्यामुळे त्या प्रत्येक कामासाठी परिगणित होणाऱ्या फायद्याची रक्कम वेगवेगळी असणार आहे. त्यासाठी आजच्या तारखेला बाजारभावानुसार असणारे निव्वळ वर्तमान मूल्य (NPV) विचारात घेण्यात आलेले आहे. अशाप्रकारचे परिगणन करण्यासाठी वापरावयाचे सूत्र (Formula) खालीलप्रमाणे आहे :-

$$\text{Discount Rate} = \frac{\text{NPV as per Table-I} \times 100}{(\text{Total NPV of quarterly bills of Balance Contract Cost})}$$

याबाबतचे उदाहरणादाखल Annexure 'A', 'B', 'B-1', 'C', 'C-1' and 'D' सोबत जोडले आहे.

उपरोक्त धारणांच्या (assumptions) आधारे कंत्राट अनामत रक्कम, रिटेंशन मनी यापैकी एका किंवा दोन्ही बाबींसाठी NPV च्या आधारे परिगणित होणाऱ्या टक्केवारीनुसार अंशतः भरपाई (offset) देऊन संबंधित कंत्राटदार प्रस्तावित सवलत घेऊ शकतो. त्याकरिता चालू कंत्राटामधून अतिरिक्त सूट देण्यास सहमत असल्याचे व कर रचनेत कोणताही बदल झाला तरी सदर सूट रक्कम वसूल करण्यास हरकत नसल्याबाबतचे रु.५००/- च्या स्टॅम्प पेपरवर प्रतिज्ञापत्र कंत्राटदाराने देणे आवश्यक असेल. अशी सवलत घेण्यासाठी कंत्राटदाराने संबंधित खाते प्रमुखांकडे लेखी अर्ज करणे अनिवार्य असेल. तदनंतर, संबंधित खाते प्रमुखाने प्रकरणनिहाय परिगणन करून त्यांच्या शिफारसीसह संबंधित प्रकरण सक्षम प्राधिकाऱ्याच्या (संबंधित

उपायुक्त) मंजूरीकरिता प्रमुख लेखापाल (वित्त)/प्रमुख लेखापाल (पा.पु.म.नि.) खात्याच्या लेखा विभागामार्फत सादर करणे आवश्यक असेल.

सदर मार्गदर्शक सूचना या महानगरपालिकेच्या हाती घेण्यात आलेल्या रु.५० लाखापेक्षा अधिक कंत्राट किंमत असलेल्या प्रकल्प व इतर कामांच्या कंत्राटांना लागू राहतील. तथापि महापालिकेच्या ज्या कंत्राटदारांविरोध्द ज्या कामांकरिता विविध चौकशी प्रलंबित आहे अशा कंत्राटदारांना त्या कामाकरिता तसेच तद्अनुषंगाने इतर कामातून रोखून ठेवलेल्या रक्कमांनासुध्द या सवलती लागू होणार नाहीत. तसेच यापुढील कामाकरिता मसुदानिविदेत परिपत्रकात नमूद केल्याप्रमाणे सुधारित टक्केवारीनुसार कंत्राट सुरक्षा अनामत आणि रिटेशन मनी बाबतची अट अंतर्भूत करणे आवश्यक असेल.

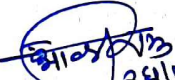
प्रमुख लेखापाल (पा.पु.म.नि.)
२५/११/२०२०

प्रमुख लेखापाल (वित्त)प्र.
२५/११/२०२०

अतिरिक्त आयुक्त (प्रकल्प)

महानगरपालिका आयुक्त

२७/८-२०

4-99
99e

Annexure-A
I-Contract Deposits/ Security Deposits (Amount in Crore)

Example:

Particular	As per Tender Condition	Revised	Margin Difference	Net '@ 6% Interest Rate	NPV
Contractor %	-13.00%				
Contract Sum	100.0000				
Work Done-Amount (Finacial Progress)	0.0000				
Balance Contract Cost	100.0000				
Contract Period (in Year)	4.00				
Work Done-Period (in Year)	0.00				
Balance Contract Period (in Year)	4.00				
DLP Period (in Year)	5.00				
Contract Deposit Amount	5.0000	2.0000			
Interest Rate	6.00%				
Bank Guarantee is issued @ 3% Bank Commission as against 1/3 cash margin required for issuance of Bank Guarantee	1.6667	0.6667	1.0000	0.5172	0.4200
				NPV-I	0.4200

P-923
329

Annexure-B

II- Retention Money (Cash)

Example:

(Amount in Crore)

Particular	As per Tender Condition	Revised	RM Relief	Amount as per @6%	Total RM relief	NPV
Balance Contract Cost	100.0000					
Balance Contract Period (in Year)	4.00					
DLP Period (in Year)	5.00					
Quarterly Payment Will be released	6.2500					
Interest Rate	6.00%					
% of Retention Money for each Bill	5.00%	2.00%				
	0.3125	0.1250				
Total Retention money	5.0000	2.0000				
Quarterly Break-up of RM						
1	0.3125	0.1250	0.1875	0.0028	0.1903	0.0028
2	0.3125	0.1250	0.3778	0.0029	0.3807	0.0028
3	0.3125	0.1250	0.5682	0.0057	0.5739	0.0055
4	0.3125	0.1250	0.7614	0.0086	0.7700	0.0082
5	0.3125	0.1250	0.9575	0.0115	0.9690	0.0109
6	0.3125	0.1250	1.1565	0.0145	1.1711	0.0135
7	0.3125	0.1250	1.3586	0.0176	1.3761	0.0161
8	0.3125	0.1250	1.5636	0.0206	1.5843	0.0186
9	0.3125	0.1250	1.7718	0.0238	1.7955	0.0211
10	0.3125	0.1250	1.9830	0.0269	2.0100	0.0236
11	0.3125	0.1250	2.1975	0.0301	2.2276	0.0260
12	0.3125	0.1250	2.4151	0.0334	2.4485	0.0284
13	0.3125	0.1250	2.6360	0.0367	2.6728	0.0307
14	0.3125	0.1250	2.8603	0.0401	2.9004	0.0330
15	0.3125	0.1250	3.0879	0.0435	3.1314	0.0353
16	0.3125	0.1250	3.3189	0.0470	3.3658	0.0376
17			3.3658	0.0505	3.4163	0.0398
18			3.4163	0.0512	3.4676	0.0398
19			3.4676	0.0520	3.5196	0.0398
20			3.5196	0.0528	3.5724	0.0398
21			3.5724	0.0536	3.6260	0.0398
22			3.6260	0.0544	3.6804	0.0398
23			3.6804	0.0552	3.7356	0.0398
24			3.7356	0.0560	3.7916	0.0398
25			3.7916	0.0569	3.8485	0.0398
26			3.8485	0.0577	3.9062	0.0398
27			3.9062	0.0586	3.9648	0.0398
28			3.9648	0.0595	4.0243	0.0398
	5.0000	2.0000	71.0961	1.0243	72.1204	0.7945
					NPV-II	0.7915

The balance Retention Money shall be released within 30 days after completion of 3rd year of DLP (in case of 5 years DLP)
or
after issue of 'Defect Liability Certificate' (in case of 1 or 2 or 3 years DLP)

4-924
322

EXAMPLE

Annexure-B-I (where Retention Money is Cash)

Table-I- Summary of NPV

Particular	NPV
I-Contract Deposits/ Security Deposits (as per Annexure-A)	0.4200
II- Retention Money (as per Annexure-B)	0.7915
Total NPV	1.2115

Table-II- Discount per Bill as per NPV

(Amount in Crore)

No of Quarters	Quarterly Break-up of Payment	NPV of Bill Amount
1	2	3 (NPV of Column no. 2)
1	6.2500	6.2500
2	6.2500	6.1576
3	6.2500	6.0666
4	6.2500	5.9770
5	6.2500	5.8887
6	6.2500	5.8016
7	6.2500	5.7159
8	6.2500	5.6314
9	6.2500	5.5482
10	6.2500	5.4662
11	6.2500	5.3854
12	6.2500	5.3058
13	6.2500	5.2274
14	6.2500	5.1502
15	6.2500	5.0741
16	6.2500	4.9991
	100.0000	89.6452

Formula:- Discount Rate

Balance Contract Cost	=	100.0000
NPV as per Table-I	=	1.2115
Total NPV of quarterly bills	=	89.6452

$$\text{Discount Rate} = \frac{\text{NPV as per Table-I} \times 100}{(\text{Total NPV of quarterly bills of Balance Contract Cost})}$$

$$= \frac{1.2115 \times 100}{89.6452}$$

$$= 1.35$$

T-924

Annexure-C
II- Retention Money Against BG
 (Amount in Crore)

Particular	As per Tender Condition	Revised	RM Relief Margin money	Amount as per @6% Interest	Total RM relief	NPV
Balance Contract Cost	100.0000					
Balance Contract Period (in Year)	4.00					
DLP Period (in Year)	5.00					
Quarterly Payment Will be released	6.2500					
Interest Rate	6.00%					
% of Retention Money for each Bill	5.00%	2.00%				
	0.3125	0.1250				
Total Retention money	5.0000	2.0000				
Quarterly Break-up of RM						
1	0.3125	0.1250	0.0625	0.0009	0.0634	0.0009
2	0.3125	0.1250	0.1259	0.0010	0.1269	0.0009
3	0.3125	0.1250	0.1894	0.0019	0.1913	0.0018
4	0.3125	0.1250	0.2538	0.0029	0.2567	0.0027
5	0.3125	0.1250	0.3192	0.0038	0.3230	0.0036
6	0.3125	0.1250	0.3855	0.0048	0.3904	0.0045
7	0.3125	0.1250	0.4529	0.0059	0.4587	0.0054
8	0.3125	0.1250	0.5212	0.0069	0.5281	0.0062
9	0.3125	0.1250	0.5906	0.0079	0.5985	0.0070
10	0.3125	0.1250	0.6610	0.0090	0.6700	0.0079
11	0.3125	0.1250	0.7325	0.0100	0.7425	0.0087
12	0.3125	0.1250	0.8050	0.0111	0.8162	0.0095
13	0.3125	0.1250	0.8787	0.0122	0.8909	0.0102
14	0.3125	0.1250	0.9534	0.0134	0.9668	0.0110
15	0.3125	0.1250	1.0293	0.0145	1.0438	0.0118
16	0.3125	0.1250	1.1063	0.0157	1.1219	0.0125
17			1.1219	0.0168	1.1388	0.0133
18			1.1388	0.0171	1.1559	0.0133
19			1.1559	0.0173	1.1732	0.0133
20			1.1732	0.0176	1.1908	0.0133
21			1.1908	0.0179	1.2087	0.0133
22			1.2087	0.0181	1.2268	0.0133
23			1.2268	0.0184	1.2452	0.0133
24			1.2452	0.0187	1.2639	0.0133
25			1.2639	0.0190	1.2828	0.0133
26			1.2828	0.0192	1.3021	0.0133
27			1.3021	0.0195	1.3216	0.0133
28			1.3216	0.0198	1.3414	0.0133
	5.0000	2.0000	23.6987	0.3414	24.0401	0.2638
					NPV-II	0.2638

The balance Retention Money shall be released within 30 days after completion of 3rd year of DLP (in case of 5 years DLP)
 or
 after issue of 'Defect Liability Certificate' (in case of 1 or 2 or 3 years DLP)

4-989
9260

Annexure-C-I (where Retention Money is BG)

EXAMPLE.

Table-I- Summary of NPV

Particular	NPV
I-Contract Deposits/ Security Deposits (as per Annexure-A)	0.4200
II- Retention Money against BG (as per Annexure-C)	0.2638
Total NPV	0.6838

Table-II- Discount per Bill as per NPV

(Amount in Crore)

No of Quarters	Quarterly Break-up of Payment	NPV of Bill Amount
1	2	3 (NPV of Column no. 2)
1	6.2500	6.2500
2	6.2500	6.1576
3	6.2500	6.0666
4	6.2500	5.9770
5	6.2500	5.8887
6	6.2500	5.8016
7	6.2500	5.7159
8	6.2500	5.6314
9	6.2500	5.5482
10	6.2500	5.4662
11	6.2500	5.3854
12	6.2500	5.3058
13	6.2500	5.2274
14	6.2500	5.1502
15	6.2500	5.0741
16	6.2500	4.9991
100.0000	100.0000	89.6452

Formula:- Discount Rate

Balance Contract Cost	=	100.0000
NPV as per Table-I	=	0.6838
Total NPV of quarterly bills	=	89.6452

$$\text{Discount Rate} = \frac{\text{NPV as per Table-I} \times 100}{(\text{Total NPV of quarterly bills of Balance Contract Cost})}$$

$$= \frac{0.6838 \times 100}{89.6452}$$

$$= 0.76$$

4/9

Annexure-D
Assumption

Particular	As per Tender Condition	Revised
Estimated Cost	114.9425	
Contractor %	-13.00%	
Contract Sum	100.0000	
Work Done-Amount (Financial Progress)	0.0000	
Balance Contract Cost	100.0000	
Contract Period (in Year)	4	
Work Done-Period (in Year)	0	
Balance Contract Period (in Year)	4	
DLP Period (in Year)	5	
Contract Deposit Amount	5.0000	2.0000
PBG Amount	1.9200	0.0000
ASD	1.1494	0.5747
% of Retention Money for each Bill	5.00%	2.00%
Interest Rate	6.00%	
Quarterly Break-up of Payment	6.2500	

परिपत्रक क्र. प्रमुख लेखापाल(वित्त)/प्रकल्प २१ दि. ०१/०८/२०२०नुसार करावयाची मानक कृती

पध्दती (Standard Operation Procedure) खालील प्रमाणे असेल.

क्र	तपशिल	कालावधी
१.	संबंधित कंत्राटदार/निविदाकार यांनी अशा प्रकारची सवलत घेण्याबाबत संबंधित खात्याच्या कार्यकारी अभियंत्याकडे लेखी अर्ज करणे आवश्यक असेल.	परिपत्रकाच्या दिनांकापासून एक महिन्याच्या आत
२.	कार्यकारी अभियंता यांनी परिपत्रकात नमूद केलेल्या सुत्रानुसार भरपाई (Offset) ची टक्केवारी परिगणित करून Excel Sheet सह प्रस्ताव प्रमुख अभियंताच्या शिफारशीसह प्रमुख लेखापाल (वित्त)/ प्रमुख लेखापाल (पा.पु.म.नि.) खात्याच्या संबंधित लेखा विभागाकडे अग्रेषित करावा.	५ कामकाजाचे दिवस
३.	संबंधित लेखा विभागाने पडताळणी करून प्रमुख लेखापाल (वित्त) / प्रमुख लेखापाल (पा.पु.म.नि.) यांच्या खातेनिहाय असलेल्या कोअर टिमकडे Excel Sheet पुर्नपडताळणी करिता पाठवावी.	५ कामकाजाचे दिवस
४.	प्रमुख लेखापाल (वित्त)/ प्रमुख लेखापाल (पा.पु.म.नि.) यांच्या खातेनिहाय असलेल्या कोअर टीमने अशा प्रस्तावांची पुर्नपडताळणी करून भरपाई (Offset) ची टक्केवारी अंतिमतः निश्चित करावी.	५ कामकाजाचे दिवस
५.	खात्याने परिगणित केलेली (Offset) ची टक्केवारी व प्रमुख लेखापाल (वित्त)/ प्रमुख लेखापाल (पा.पु.म.नि.) खात्यामार्फत पडताळण्यात आलेल्या (Offset) ची टक्केवारी दर्शविणारी Excel Sheet सह जर प्रकल्पाची कंत्राट सम रु १०० कोटी पेक्षा कमी असल्यास प्रमुख लेखापाल (वित्त)/ प्रमुख लेखापाल (पा.पु.म.नि.) त्यांच्या अभिप्रायासह भरपाई (Offset) च्या टक्केवारीच्या मान्यतेसाठी संबंधित उपआयुक्त/ सह आयुक्त यांच्या मान्यतेकरिता, तसेच जर कंत्राट सम रु १०० कोटी किंवा त्यापेक्षा जास्त असल्यास भरपाई (Offset) च्या टक्केवारीकरिता अति. आयुक्त (प्रकल्प) यांच्या मान्यतेकरिता सादर करतील. व मान्यता प्राप्त झाल्यानंतर प्रकरण नस्ती खाते प्रमुखाकडे अग्रेषित करतील.	५ कामकाजाचे दिवस

६.	सक्षम प्रधिकान्यांची मान्यता प्राप्त झाल्यानंतर खाते प्रमुख अशा प्रकारे अंतिम झालेली भरपाई (Offset) ची टक्केवारी संबंधित कंत्राटदार/निविदाकार यांना लेखी/ ई-मेल द्वारे कळवतील.	२ कामकाजाचे दिवस
७.	संबंधित कंत्राटदार/निविदाकार यांनी कंत्राटामधून अतिरिक्त सूट देण्यास सहमत असल्याचे व कर रचनेत कोणताही बदल झाला तरी सदर सूट रक्कम वसूल करण्यास हरकत नसल्याबाबतचे रु.५००/- च्या स्टॅम्प पेपरवर प्रतिज्ञापत्र संबंधित कार्यकारी अभियंता याच्याकडे सादर करतील	५ दिवस कामकाजाचे दिवस
८.	कंत्राटदाराने प्रतिज्ञा पत्र सादर केले असल्यास , त्या कंत्राटदारांच्या ज्या प्रकल्प कामास सदर योजना दि.०१.११.२०२० या दिनांका नंतर संपकार्यप्रणालीत प्रक्रिया होणाऱ्या देयकांना लागू असेल.	
९.	उपरोक्त मान्यतेनंतर जर कंत्राटदाराने २% पेक्षा जास्त कंत्राट सुरक्षा रक्कमेसाठी बँक हमीपत्र दिलेले असल्यास अश्या कंत्राटदाराकडून २% कंत्राट सुरक्षा रक्कमेचे बँक हमीपत्र प्राप्तकरून वाढीव बँक हमीपत्र परत करण्याची कार्यवाही करण्यात यावी.	५ दिवस कामकाजाचे दिवस
१०.	संबंधित कार्यकारी अभियंत्याने भरपाई (Offset) च्या टक्केवारीनुसार परिगणित होणारी रक्कम प्रत्येक देयकातून वसूल करून स्वतंत्र लेखाशिर्षात (G.L.code) जमा करण्याची दक्षता घ्यावी. तसेच अशा प्रकारच्या देयकातून फक्त २% रिटेशन मनी वसूल करावा.	

MUNICIPAL CORPORATION OF GREATER MUMBAI c/13

Circular No. D.M.C.S.W.M./67, D-4 E6 APR 2018

Hon. Supreme Court of India has passed orders in the Special Leave Petition (Civil) No. D 23708 / 2017 dated 15/03/2018. Accordingly MCGM shall permit a builder or developer to carry on Construction at their sites for deposition of C & D waste subject to following procedure. The approval to the C & D "Waste Management Plan" (WMP) for transportation of C & D waste to designated unloading sites shall be provided by applicant on line.

A) For Existing designated unloading sites -

1. Consent Letter along with notarized documents from the land owner of the designated unloading site and mentioning Quantity of C & D Waste that can be accommodated along with time period.
2. Name, address, contact person of the transporting agency.

B) For Approval of New C & D waste unloading sites -

The builder/developer shall apply to Solid Waste Management Department with following details :-

1. The Owner/ POA shall submit an Application for the purpose of declaring the Site/Land as "Approved designated Unloading site" for unloading of C & D waste as per C & D Waste Management Rules, 2016.
2. The Application shall accompany with
 - (i) Property card and/ or 7/12 extract, Location Plan, Plot Boundary with Contour Map, Quantity of C & D waste which can be unloaded and Period.
 - (ii) Title Report from Advocate in practice having 5 years of experience, indicating the title of applicant.
3. The site will be inspected by Zonal E.E. (SWM) for its suitability for unloading of C & D waste within 15 days of application. If site is found to be acceptable, the Approval shall be granted to the new site as "designated unloading site" to receive C & D Waste. This site shall be made available for on line approval of C & D "Waste Management Plan".
4. The builder / developer shall pay Bank Guarantee online as per annexure-A based on the plot area of construction site.

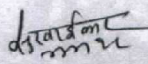
Ch.E. (S.W.M.)

D.M.C. (S.W.M.)

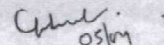
A.M.C. (E.S.)

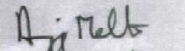
M.E. 5/4/18

Municipal Corporation of Greater Mumbai

No. Dy.Ch.Eng./SWM/3957/Op. dt. 10/9/2018

CIRCULAR

28-9-2018

Subject: Implementation of the Construction and Demolition Waste Management Rules, 2016

Reference: i) Hon'ble Supreme Court's order in the Special Leave Petition (civil)
No: D 23708/2017, dated 15/03/2018

ii) Hon'ble M.C. Sir's Approval u/no. MGC/F/7076 dtd. 30.08.2018

The Construction and Demolition Waste Management Rules, 2016 is applicable to 'every waste resulting from construction, re-modeling, repair and demolition of any civil structure of individual or organisation or authority who generates construction and demolition waste such as building materials, debris, rubble'.

Hon'ble Supreme Court vide order dated 15/03/2018, has directed to dispose of construction and demolition waste material by following due procedure in accordance with the provisions of the Construction and Demolition Waste Management Rules, 2016".

In order to put curb on the un-authorisedly dumped waste, it is essential to control it by asking ward Maintenance department or any MCGM department to issue work-permission only after assessing the total estimated quantity of C&D waste likely to be generated out of the repairs / construction / trenching work or any such civil works, and asking them to make payment in advance or in stages of waste generation for the 'Debris on Call' system or transport C&D waste to designated unloading site.

Following standard operating procedure is proposed to be adopted:

- 1) MCGM department like A. E. (Maintenance), A. E. (B&F), H.E., S.O., S.P., M.S.D.P., W.S.P., S.W.D., S.W.M., C.E., B.C., B.M., Roads, Bridges, etc. carrying out civil work / repairs works etc. shall put condition in the tender / quotation / work order to dispose of C&D waste generated either by (i) 'Debris on Call' scheme if generation of C&D waste is less than 300MT for entire project or (ii) contractor shall transport to designated unloading site approved by MCGM S.W.M. department by following due procedure if C&D waste is more than 300MT for entire project.
- 2) The estimated quantity of the C&D waste generated shall be certified by A.E. (Maintenance) Ward or the concerned department.
- 3) If quantity of C&D waste is less than 300MT, A. E. (S.W.M.) Ward will issue Challan for making payment as per 'Debris on call' scheme on approval from Zonal Ex. Eng. (S.W.M.).
- 4) If quantity of C&D waste is more than 300MT, the contractor / agency will submit C&D waste management plan complete with requisite documents to Zonal Ex. Eng. (S.W.M.). On approval, the contractor / citizen / agency carrying out the civil works will be allowed to transport the C&D waste material to the designated unloading site.
- 5) The contractor / citizen / agency carrying out the civil works shall maintain & submit the appropriate record like date, quantity of C&D waste transported, vehicle No., Challan of Receipt of C&D waste from unloading site etc.
- 6) The whole system of issuing NOC for C&D waste transportation and payment will be made ONLINE and for this M/S. Softtech will be asked to develop appropriate software on the basis of existing norms being done for auto-DCR portal.
- 7) The proposals will be processed manually till the complete system fully operational online.
- 8) All the contractors / agencies using designated unloading site must maintain proper record of the C&D waste generated and transported along with date and vehicles through which C&D is transported & the copies of Challans from unloading site for having unloaded the C&D waste and submit the same to A.E. (S.W.M.) ward through concerned department.

Sd/-07/08/2018
Ch. Eng. (S.W.M.)

Sd/-07/08/2018
D.M.C. (S.W.M.)

Sd/-10/08/2018
A.M.C.(E.S.)

Sd/-29/08/2018
Municipal Commissioner

Ch Eng (SP) Submitted, please.

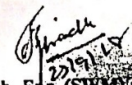
Dy. Ch. Eng. (S.W.M.)

बृहन्मुंबई महानगरपालिका

परिपत्रक

२०२०-२१

क्र.प्रले(वित्त)/४२ दिनांक .०९.१.२०२१

विषय:- बृहन्मुंबई महानगरपालिकेत कंत्राटदारामार्फत पार पाडावयाच्या कामाच्या मसुदा निविदेमध्ये अतिरिक्त सुरक्षा अनामत रक्कमेबाबतची सुधारित अट समाविष्ट करण्याबाबत.

संदर्भ:- एमडीडी/७८७८ दिनांक २७.०९.२०१६.

बृहन्मुंबई महानगरपालिकेत कंत्राटदारामार्फत पार पाडण्यात येणाऱ्या कामाकरिताच्या मसुदा-निविदेत समाविष्ट करावयाच्या अतिरिक्त सुरक्षा अनामत रक्कमेबाबतच्या अटीबाबतचे निर्देश संदर्भित परिपत्रकाच्या निर्गमित करण्यात आले आहेत. त्यामध्ये खालीलप्रमाणे सुधारणा करण्यात येत आहे.

विद्यमान पध्दत:-

ई-निविदा सूचनेस प्रतिसाद करून ज्या ज्या कंत्राटदारांनी वजा -१२% पेक्षा कमी दराने टक्केवारी उद्धृत केली आहे, अश्या सर्व कंत्राटदारांना वजा १२% पेक्षा जास्त नमूद केलेल्या प्रत्येक टक्क्याला १% याप्रमाणे कोणतीही मर्यादा न ठेवता ऑनलाईन निविदा सादर करताना अतिरिक्त सुरक्षा अनामत रक्कम ऑनलाईन स्विकारली जाते.

सुधारित पध्दत:-

- कंत्राटदाराने वजा -१२% पेक्षा कमी दराने टक्केवारी उद्धृत केली असल्यास वजा १२% पेक्षा जास्त असलेल्या प्रत्येक टक्क्याला १% याप्रमाणे ऑनलाईन निविदा सादर करताना अतिरिक्त सुरक्षा अनामत रक्कमेचा ऑनलाईन भरणा करणे आवश्यक नसेल.
- कंत्राट रकमेनुसार सक्षम प्राधिकार्यांची मंजूरी प्राप्त झाल्यानंतर प्रथम लघुतम असलेल्या निविदाकाराने कार्यस्विकृती पत्रात नमूद केल्यानुसार कार्यालयीन कामकाजाच्या १५ दिवसात विद्यमान पध्दतीनुसार अतिरिक्त सुरक्षा अनामत रक्कम डिमांड ड्रफ्ट स्वरूपात महानगरपालिकेचा नागरी सुविधा केंद्रात जमा करणे व त्या पावतीची प्रत खातेप्रमुखाकडे सादर करणे आवश्यक असेल.
- जर प्रथम लघुतम निविदाकाराने कार्यस्विकृती पत्रात नमूद केल्यानुसार कार्यालयीन कामकाजाच्या १५ दिवसांमध्ये अतिरिक्त सुरक्षा अनामत रक्कम जमा केली नाही तर खदर कंपनीने भरणा केलेली संपूर्ण इसारा अनामत रक्कम (EMD) जप्त केली जाईल तसेच कंपनीला दोन वर्षासाठी डीबार (Debar) करण्यात येईल, त्याचप्रमाणे त्या कंपनीचे संचालक/

LoA)

Cable printing

पार्टनर इतर कंपनीमध्ये संचालक/ पार्टनर म्हणून कार्यरत असतील तर ती कंपनी सुद्धा दोन वर्षांकरिता डीबार (Debar) करण्याची कार्यवाही करण्यात येईल.

वापुढील कामाकरिताच्या मसुदांनिविदेत परिपत्रकात नमूद केल्याप्रमाणे अतिरिक्त सुरक्षा अनामत रकमेबाबतची अट अंतर्भूत करण्यात यावी.

उपरोक्त सूचनांचे काटेकोरपणे अंमलबजावणी करण्याबाबत सर्व खाते प्रमुख/ सहाय्यक आयुक्त/ रुग्णालय अधिष्ठाता/ वैद्यकीय अधीक्षक/ उप प्रमुख लेखापाल/ लेखा अधिकारी यांनी दक्षता घ्यावी.

09/02/2021
(रा. क. आ. आ. आ.)

प्रमुख लेखापाल (विह)प्र.

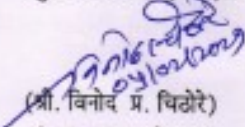
09/02/2021
(श्री. विनोद प्र. पिठोरे)

संचालक (अ.से.व.प्र)

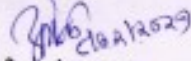
09/02/2021
(श्री. अनंत कदम)

उपायुक्त - (पायाभूत सुविधा)

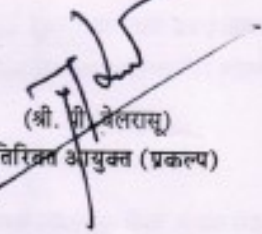
(श्री. पी. बी. बी. बी.)

अतिरिक्त आयुक्त (प्रकल्प)

(श्री. इ. बी. बी. बी.)

महानगरपालिका आयुक्त

09/02/2021

बृहन्मुंबई महानगरपालिका

परिपत्रक

प्र.ले./वित्त/प्रकल्प/ 25 दि. 12/07/2022

विषय: महानगरपालिकेद्वारे हाती घेण्यात येणारी विविध प्रकल्प कामे तसेच प्राप्त करण्यात येणा-या वस्तु व सेवा इत्यादीबाबतच्या ई-निविदा/निविदा/दरपत्रक यामध्ये वस्तु व सेवा कराच्या अनुषंगाने अंतर्भूत करावयाच्या अटीबाबत.

संदर्भ: १) प्र.ले./वित्त/प्रकल्प/शाहर/३३ दि.०४.०३.२०१७

२) प्र.ले./वित्त/प्रकल्प/शाहर/१२०अ दि.०८.०५.२०१७

३) प्र.ले./वित्त/प्रकल्प/शाहर/८ दि.१४.०७.२०१७

४) प्र.ले./वित्त/प्रकल्प/शाहर/२८ दि.१०.११.२०१७

५) Press Release: 47th Meeting of the GST Council, Chandigarh
28th and 29th June, 2022.

बृहन्मुंबई महानगरपालिकेद्वारे हाती घेण्यात येणाऱ्या विविध प्रकल्प कामे तसेच प्राप्त करण्यात येणा-या वस्तु व सेवा इत्यादीबाबतच्या ई-निविदा/निविदा/दरपत्रक यामध्ये वस्तु व सेवा कराच्या अनुषंगाने अंतर्भूत करावयाच्या अटीबाबत संदर्भित परिपत्रकान्वये सूचना प्रसूत केल्या आहेत.

वस्तु व सेवाकरांच्या दरात फेरबदल करण्याबाबत शासन विचाराधीन असल्याने महानगरपालिकेतील विविध कामांच्या निविदांबाबत संपाद्य निविदाकार महापालिकेस निवेदन सादर करत आहेत. अतएव, महानगरपालिकेद्वारे हाती घेण्यात येणारी विविध प्रकल्प कामे तसेच प्राप्त करण्यात येणा-या वस्तु व सेवा इत्यादीबाबतच्या ई-निविदा/निविदा/दरपत्रक यामध्ये संदर्भित क्र.५ अन्वये दिलेल्या वस्तु व सेवा कराच्या अनुषंगाने अंतर्भूत करावयाच्या अटीमध्ये खालीलप्रमाणे बदल करण्यात येत आहे.

विद्यमान अट	सुधारीत अट
<p>"GST and other state levies/cess which are not subsumed under GST will be applicable. The tenderer shall quote inclusive of all taxes. It is clearly understood that BMC will not bear any additional liability towards payment of any Taxes & Duties.</p> <p>Wherever the services to be provided by the Tenderers, falls under Reverse Charge Mechanism, the Price quoted shall be exclusive of GST, but inclusive of Taxes/Duties/Cess other than GST, if any.</p> <p>Rates accepted by BMC shall hold good till completion of work and no additional individual claim shall be admissible on account of fluctuations in market rates; increase in taxes/any other levies/tolls etc. except that payment/recovery for overall market situation shall be made as per Price variation.</p>	<p>"GST and other state levies/cess which are not subsumed under GST will be applicable. The tenderer shall quote inclusive of all taxes <u>applicable at the time of bid submission</u>. It is clearly understood that BMC will not bear any additional liability towards payment of any Taxes & Duties.</p> <p>Wherever the services to be provided by the Tenderers, falls under Reverse Charge Mechanism, the Price quoted shall be exclusive of GST, but inclusive of Taxes/Duties/Cess other than GST, if any.</p> <p>Rates accepted by BMC shall hold good till completion of work and no additional individual claim shall be admissible on account of fluctuations in market rates; increase in taxes/any other levies / tolls etc. except that payment/recovery for overall market situation shall be made as per Price variation and if there is any subsequent change (after submission of bid) in rate of GST applicable on the work/services to be executed as per tender, i.e. any increase will be reimbursed by BMC whereas any reduction in the rate of GST shall be passed on to BMC as per the provisions of the GST Act.</p>

उपरोक्त सुधारीत अट ही ज्या कामांच्या ई-निविदा/निविदा/दरपत्रक दस्तऐवज वामध्ये समाविष्ट केलेली असेल फक्त त्याच कामांकरिता लागू असेल.

अतएव, प्राप्त होणारे देकार प्रचलित वस्तु व सेवा करांच्या दरानुसार प्राप्त होणार असल्याने, सध्या ज्या ई-निविदा/निविदा/दरपत्रक मार्गविलेल्या आहेत अशा निविदांमध्ये

नियत दिनांकापूर्वी शुद्धीपत्रकाद्वारे उपरोक्त सुधारीत अट समाविष्ट करण्याबाबत तसेच चापुते भागविण्यात येणाऱ्या ई-निविदा/निविदा/दरपत्रक यांमध्ये उपरोक्त सुधारीत अट समाविष्ट करण्याची संबंधित खातेप्रमुख यांनी रक्षता घ्यावी, तसेच वस्तु व सेवा कराच्या दरातील बदल हा शासन निर्णयामधील दिनांकापासून प्रभाव्य राहिल.

सर्व खातेप्रमुख, रूग्णालयांचे अधिकाऱा, सहायक आयुक्त, यांनी उपरोक्त सुचनांचे काटेकोरपणे अनुपालन करावे.

(चंद्रुरंग गोसावी)

प्रमुख लेखापाल (पा.पु.न.वि.)

(रामदास अगडा)

उप आयुक्त (वित्त)

(प्रदिप चवहळ)

प्रमुख लेखापाल (वित्त) प्र.

(श्री. अनिल कुलकर्णी) ११४
अतिरिक्त सहायक (अकरण)

30 AUG 2022
3217

प्र.अधिकारी (पत्रक)
रुग्ण प्रसंगित करणे
कार्य. अति. (रीस) मधु अति. (पत्रक)

MUNICIPAL CORPORATION OF GREATER MUMBAI

CIRCULAR

U/No.MGC/F/6342 dated 5.5.2018

Sub.: Revised guidelines regarding barricades being used during the execution of various infrastructure development projects by MCGM in Mumbai.

Various infrastructure development projects are being executed by MCGM for the betterment of citizens of Mumbai. During the course of execution of the projects, it is necessary to provide strong and secured barricading as a safety measure to avoid any mishaps as well as to avoid nuisance to vehicular and pedestrian traffic. Nowadays, the following types of barricades are being used exclusively in MCGM as per the convenience of various departments at different sites.

1. Water/sand fillable PVC Metro barricades.
2. RW 7.45 (G.I. sheets of 22 gauge fixed on 3 inch dia. Wooden bullies buried in existing road sufficiently)
3. RW 7.36 (G.I. sheets of 22 gauge fixed on MS Angle post buried in half the depth in drums of 20 litres capacity in 1:3:6 concrete)
4. Structural steel barricade for major trenches having depth more than 2.00 meters.

Thus from the above, it can be seen that there is no uniformity in provision of barricades as they are of different size and shape. Further it is also observed that the continuity is not maintained in providing the barricading keeping gaps in between thus endangering the safety of vehicular as well as pedestrian traffic. Also the barricades are not being cleaned, thus further adding to shabbiness. Further Mumbai being the financial capital of India, people from all over the world visit the city daily and to maintain good image of city the following decisions are taken.

- A) Only two type of barricades having department wise colour coding are proposed to be used depending upon the nature of work i.e. Minor and Major.
- i) **Minor works:** Barricading made out of 1.5 mm thick MS plate fixed on M.S. angle post/ frame of 65 mm X 65 mm X 6 mm having height of 1.5 m supported on as shown in Annex-I.
 - ii) **Major works:** Structural steel barricade made out of 1.50 mm thick M.S. Plate ISMB 250, ISLC 250X50mm and ISA 50mmX50mmX6 mm having of size 2.5 m X 2 m as shown in Annex-II.
- B) The department wise colour coding for the barricading shall be as under:-
- i) H.E. & W.S.P. department – **Blue**
 - ii) Roads, Traffic, Bridges and Coastal Roads department– **Yellow**
 - iii) S.P. & S.O department – **Green**
 - iv) S.W.D., Building Maintenance department & for ward works – **Red**
- C) The basic principle behind installing secured and continuous barricading is to ensure the safety of vehicular as well as pedestrian traffic and residents in the nearby vicinity of the project. Due to non-installation of appropriate barricades on sites if any mishap occurs leading to injury or loss of life, then the contractor and contractor's Engineer in-charge will be liable for the consequent action.
- D) During the course of execution of project, if it is noticed that the contractor has not provided barricading then a penalty of Rs.1000/- per meter per day will be imposed upon the contractor and will be deducted from the due Bill. This penalty shall be a part of penalty as per tender condition.
- E) Details of the work shall be prominently displayed on the central panel of the barricades along-with the Social Slogans as given in Annexure III and the Cycle of the same shall be maintained.
- F) The contractor shall provide and install the barricading alongwith the slogans printed as per the Annexure III, at his own cost and no payment will be made for this, however the contractor shall quote the bid accordingly by considering the cost of barricading.

The condition shall be included in the tender as given below. “
Barricading shall be provided free of cost as per Circular vide U/No.MGC/F/6342 dated 5.5.2018 and as per Annexure I, II and III of Standard drawings and specifications with slogans and department wise colour codes.” The copy of circular will be attached to the tender as a part of tender document.

This circular will be applicable for the new tenders proposed to be invited from 01.06.2018 and also the corrigendum shall be attached to tenders which are uploaded. However, for the projects wherein the tenders are already invited, the barricading shall be provided strictly as per tender condition. All the details (Annexure I, II & III of Standard drawings and specifications with slogans and department wise colour codes, sketches and department wise colour coding) are uploaded on MCGM portal.

This circular shall come in force with immediate effect.

sd/- 20.4.2018
(Shri V.P . Chithore)
Dir.(ES&P)

sd/- 20.4.2018
(Shri R. B. Bambale)
D.M.C.(S.E.)

sd/- 21.4.2018
(Shri Vijay Singhal)
A.M.C.(E.S.)

sd/- 21.4.2018
(Dr. Shri Sanjay Mukherjee)
A.M.C.(P.)

sd/- 5.5.2018
(Shri Ajoy Mehta)
M. C.

sd/- 16.5.2018
(Shri V.P . Chithore)
Dir.(ES&P)

sd/- 16.5.2018
(Shri P. R. Kadam)
D.M.C.(S.E.)

SECTION – 20

FINANCIAL BID FORM

(FORM 'B')

Financial Bid Form 'B'

Sub: e-tender no:- 7200037494 ES - 435 Training and Widening of Laxmibaug nalla at Sidhrameshwar Nagar, Ghatkopar (E) in N Ward.

Due Date of e-Tender: As on cover page.

Sr. No.	Brief description and office estimate
1.	ES - 435 Training and Widening of Laxmibaug nalla at Sidhrameshwar Nagar, Ghatkopar (E) in N Ward.

I/We have received, read and am/are agreeable to the content of page no. 01 to page no.248 including the Bill of Quantities while quoting the percentages offered. I/We have considered the contents of the documents contained in the above mentioned pages and into thereof, I/We have signed the documents.

Name and Title of Signatory:

Name of Tenderer(s) :

Address :

E-Mail Address of the firm:

Telephone numbers :

**Digital Signature of Tenderer(s)
Trading under the Name and style of**

(A separate sheet must be filled, scanned and uploaded in packet B along with e-tendering)